

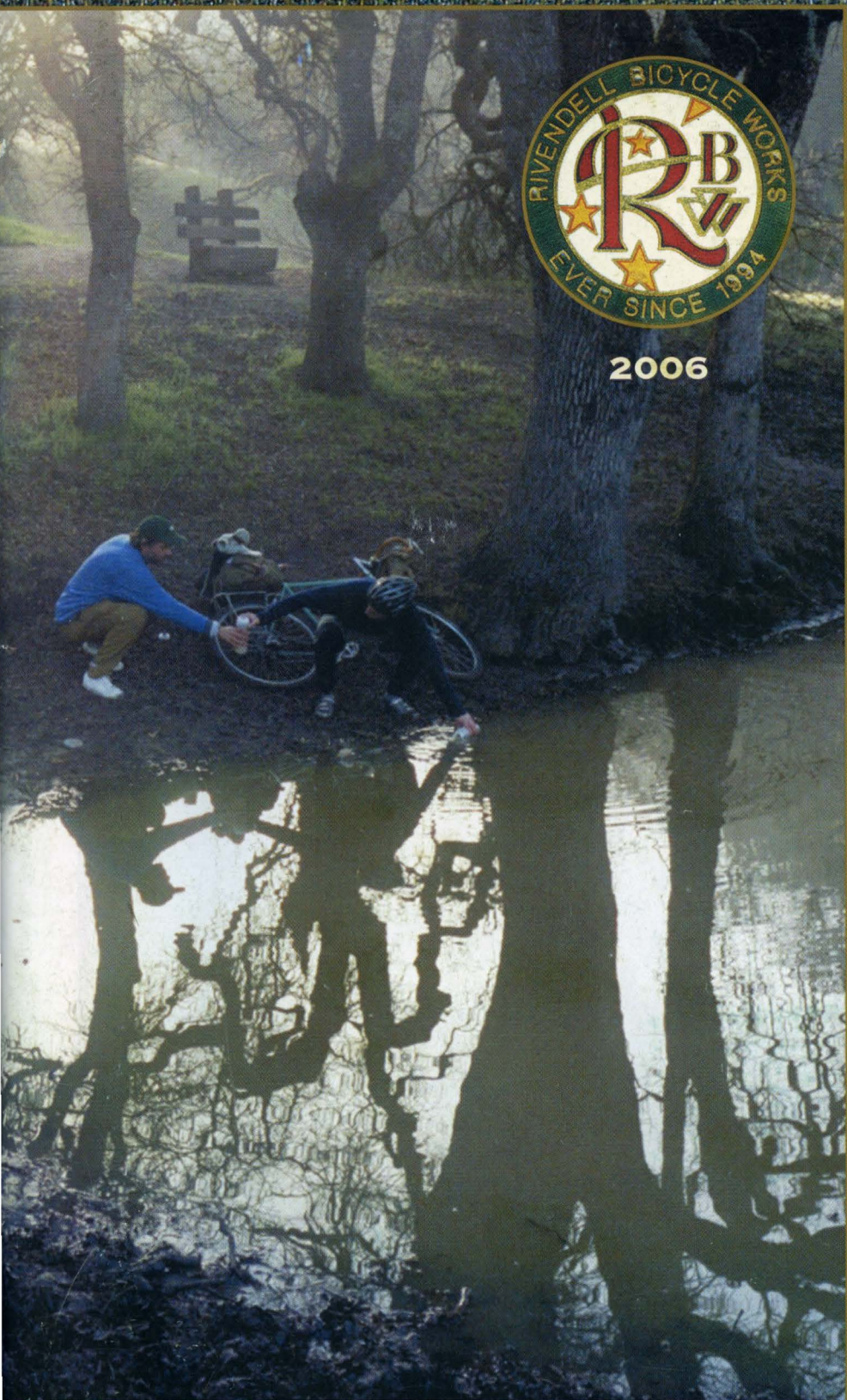

2006





All of the actual colors look better than all of the patches here. You can see the colors online at [rivbike.com](http://rivbike.com), but the real ones also look better than those do.

Aboutus ..... 2 to 3

Wool and MUSA clothing and related items, such as suspenders ..... 4 to 21

Helmet, and then the bags ..... 22 to 31

Racks and baskets ..... 32 to 37

Handlebars and tape, twine, plugs, etc ..... 38 to 46

Stems ..... 47 to 51

Saddles and seat posts ..... 52 to 58

Shifters & derailleurs ..... 59 to 66

Bottom brackets, chains, cassettes, and cranks ..... 67 to 69

Pricing, and Tips For Happy Riding ..... 70 to 71

Pedals & brakes & kickstands. Unfancy things. .... 72 to 82

Sizing and saddle height ..... 83 to 84

Tires, tire tools and pumps, and hubs ..... 85 to 92

Cooking gear, suggestions ..... 93 to 94

Tools, bottle cages, bells, and the Laddie pencil and RR back issues ... 95 to 98

Everything else ..... 99 to 112

Copying the wrong bikes ..... 104 to 106

Readers, history, subscription form, staff bios, and order form ..... 109 to 112

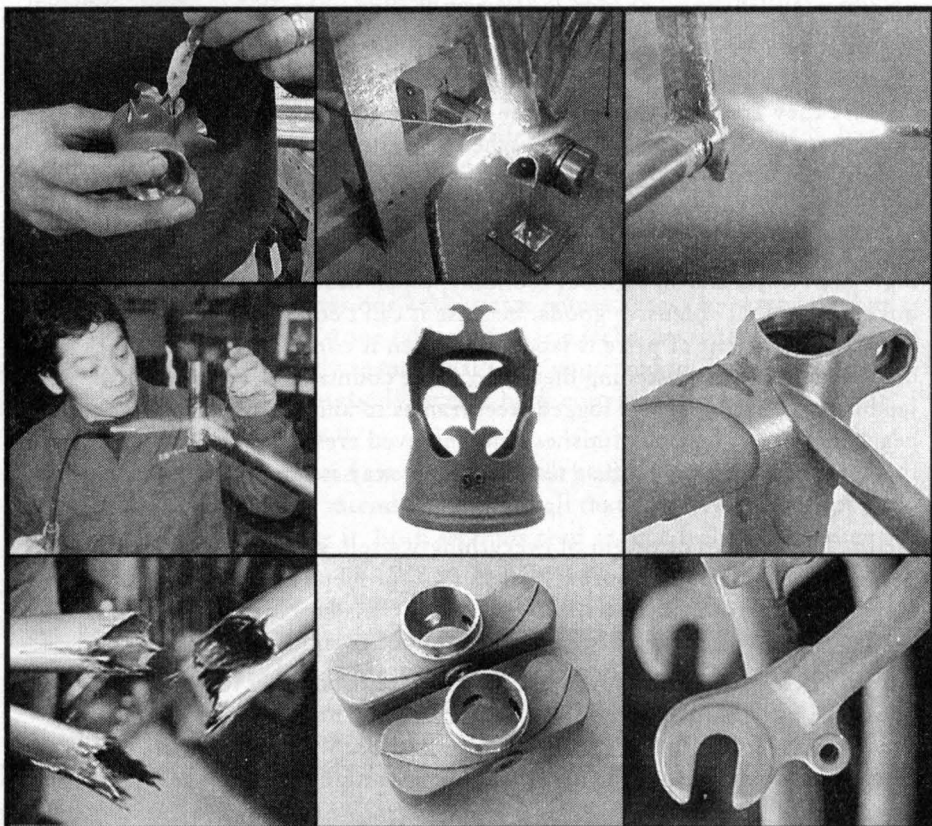



Standing: Resident pacifist Mo, Daniel, Miesha, Keven, Stephanie, Mary, Rich, Grant, John  
Sitting from left: Mark, Robert, and Brian

## Aboutus

Our business is often labeled this or that by journalists or internet pundits who understand a limited number of business models and want us to fit into one of them. Our business isn't all that complicated, but a label can't sum it up either, so I'll try to do that in the next 900-or-so words.

WE'RE A TWELVE-PERSON, TWELVE-YEAR OLD bike company specializing in the kinds of bicycles and gear that must be behind or ahead of their time, because they aren't all the rage these days. We sell some normal things you can get at any bike shop, but only when any alternatives would be awkward and no option at all would leave a gap—like brake cables, for instance. I don't care what anybody says: There's no doing without brake cables.

A lot of what we offer is made in Japan, and that's unusual these days. With high labor costs and in a global economy, Japan has lost most of its export business in labor-intensive goods, because it can't compete on price, and the highest component of price is labor. But when it comes to bicycle-things made of smooth & glistening metal, no other country can compete with Japan. From brass bells to lugged steel frames to aluminum handlebars with beautiful curves, luscious finishes, and engraved crests, Japan is at the top of the heap. It has to be, because that's the only way it can compete in a price-obsessed world.

We list the country of origin of everything we sell, so you won't have to guess which country "imported" refers to. Our menu includes clothing and bicycle goods from Australia, New Zealand, Canada, Norway, Scotland, England, Ireland, Italy, Japan, Taiwan, Minnesota and Kentucky.

Our big ticket items are bicycle frames, and we make only lugged steel ones. The only saddles we sell are leather. We sell lots of woolly clothing, and go to great lengths to get all wool, no blends. When a blend is inevitable, we make sure the wool content is as high as we can get it.

I'd say our typical customers are men and women between 40 and 65. They're athletic & adventurous, usually successful or good at something in their life, and are relatively settled, not grasping or searching for themselves or trying to fit in somewhere. They're smart, love to ride bikes, usually own modern bikes and gear, and come to us when they realize it's not working out and they think maybe another approach will work. Or they just like the oddball stuff we have.

We like bike parts and things that make your bike more versatile, comfortable, and fun. We don't cater to racers, not even a little. We're not diverse in our selection, but what we have is good.

The things we offer here are the things we ourselves use all the time. We prefer plain to fancy, simple to complicated, natural to synthetic, originals to copies, chocolate to chard, and things made by users to things made by workers who are emotionally un-attached to the goods they produce.

We seek out manufacturers whose approaches and abilities are a good match with our delivery requirements, and sometimes it takes a while to get in the groove. Invariably, they're small and specialty makers who are happy for the business, and we get along well with all of our vendors, because we don't whine and we pay on time, every time. When we have a track record of good orders and prompt payments, they're more likely to make a special color for us, or make a whole new garment or whatever it is.

We don't take advantage of that rareness or exclusivity by jacking up prices—like, *we're the only game in town, so if you want it, pony up*. Although a diligent recluse with a computer can knuckle down for a few hours on the internet and find a lower price on some of our more generic items, our prices are fair and on the low *side*, given the quality. Since we buy direct and sell direct, we're able to sell those expensive-to-make Japanese things at about the same price carbon fiber equivalents that come from China and cost a small fraction as much to make.

You know, that's a difference between high tech and craft. High tech is buzzwords, hype, material, features, and has high profit margins and widespread appeal. Craft is less showy and suffers on the pop charts for it, but ultimately is more satisfying to own and use for a long term (in this case) bicycle rider. We're all for high-tech computers, though. We run the business on Macs, and see no contradiction. To a person, though, in our lives-away-from work, we use manual typewriters and abacuses. You should, too!

In this catalogue, sometimes our enthusiasm comes across too strongly, but it's just a catalogue, not a stone tablet. The tone lacks consistency, varying from no-nonsense to nearly inane. That's not contrived, it just reflects the mood swings that affect anybody, even a hack copywriter. That stuff about the abacuses, don't believe it.

As I read over this blurb and the one in the back about road bike design, I detect a tone that I didn't intend and am not all that comfortable with, but I don't know how to change it. Both sections read as one declarative sentence after another, like that of a pile driver, ramming the message home. It comes from wanting to say exactly what I want to say, and I think I'm saying it, but maybe not getting it through or saying it the way I want to say it.

I feel lucky and scared and enthusiastic. We have too many balls in the air, and I'm afraid we'll drop some. I'm behind on my Thank You notes. Thanks for giving us a chance to be part of...well, if not your *life* life, at least your bicycle life. That's a lot, right there.—Grant

## Wear What Sheep Grow

If folks who live in close proximity to black holes in outer space came here today and studied hikers, climbers, outdoor magazine cover models, or cyclists, they would get a false idea of the clothing and equipment required to survive & enjoy life outdoors. Most of today's "outdoor" fabrics were born inside a lab, and relentless promotional campaigns can make even the ultra-sane wonder: Do natural materials even work?

We wouldn't be here now if they didn't, and neither would sheep. Wool has evolved over hundreds of thousands of years in the snowy crags of Scotland, the blistering wastelands of Afghanistan, and the bitter cold deserts of Mongolia. It will keep you comfortable in town, the woods, the mountains, and on the sea shore.

Wool regulates body heat much better than polyanything does, so you're more comfortable in a wider range of temperatures. A wool fiber is far more complex than a synthetic one, and its complication evolved to protect sheep from heat and cold and wolves. If it's really cold and windy you may need a shell on top of the wool, and if it's super hot out nothing beats a loose cotton seersucker; but day in and day out, wool's the ticket.

What's most impressive is wool's feel. Compared to the scientifically produced consistency and plush weightlessness of polar fleece—and despite science's attempt to soften it beyond reason (and ever-lowering our tolerance to texture)—wool still feels better than any synthetic. It's not as velvety-plush, but it feels real.

And unlike synthetics, which stink when they're dirty with sweat, wool doesn't stink after you've sweated in it, so you can wear it many times before you need to wash it. Once you collect a few sleeveless t's, short-sleeved t's, long-sleeved t's of various weights, and a few jerseys and heavier sweaters, you're loaded for bear and won't have more than a couple of wool loads a month, if you wear it and sweat in it every day.

Washing it is easy, and we tell you how next door. Wool dries in a day in a room. You can dry it in the dryer, too, which is our recommendation if you're in a real hurry.

The clothing you wrap yourself in becomes your immediate environment, and plays a huge role in your outdoor experience. How it looks, feels, sounds when it flaps in the wind, and smells after the third day without washing depends on what it's made of. Wear synthetics at the mall and disco. Out in the world, wear wool!

### Why wool doesn't stink

by Mary Stipe

There are two kinds of sweat glands—apocrine glands, the type found in your armpits, and eccrine glands, the type found everywhere else.

Eccrine gland secretions don't smell, and thank goodness. But apocrine gland secretions are released through the same pores as the oil glands, and when bacteria on the skin's surface feeds on the fats in these secretions, run for cover and plug your nose!

When this happens, the last thing you want to do is trap the moisture on your body and in your clothing. Unfortunately, that's exactly what happens with most synthetics. But not with wool.

Wool is "hygroscopic," which means it easily absorbs moisture. Although other natural fibers have this ability, none beats wool. Moisture passes through it and is released into the air instead of remaining on the skin. Wool absorbs about 30 percent of its weight in moisture, so it can hold that much without making you feel clammy. Nylon absorbs 4.5 percent, and polyester, just 0.4 percent. With these fibers, moisture remains on the skin and the surface of the fabric, giving that bacteria a veritable feast. You get the leftovers—sticky skin and a pungent aroma. A fabric's ability to wick moisture does not make it immune to this, as anybody who has sweated in high-wick fabrics can attest.

*Mary Stipe is a freelance writer specializing in textiles.*



## Wool Grades & Scratchiness

There are 25,400 microns to the inch

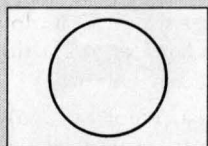

### *Coarse*

28+ microns

Strongest & most durable. Good for lumberjackwear, carpets, & blankets, but not baby blankets.

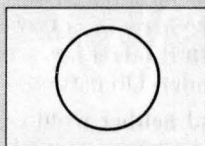

### *Medium*

23-27 microns

For woven shirts (like Pendletons) and sweaters. Some guys can wear this directly on skin, but no women can.

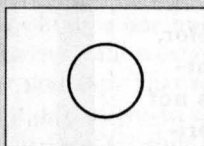

### *Fine*

20-22 microns

Great for outerwear, but guys can wear it next to their skin, and most women can, too. Soft.

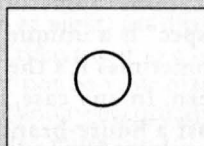

### *Superfine*

17.5-19 microns

“Girl’s wool,” but guys like it too. Skinny, flexible fibers don’t poke. It won’t bother anybody, ever.

## Sizing & washing & drying our wool

**Sizing.** How do you like your t-shirts to fit? The Australian & WoolyWarm tops fit snugly, so buy up two sizes if you like baggy. I’m 5-10 x 185lb and wear a large dress shirt, and I don’t like clingy clothes, so I wear a 2XL in these (a large MUSA seersucker is fine). This year we have a Jumbo. You don’t have to be jumbo to wear it; you just have to like loose.

**Washing.** Warm on gentle cycle has little to no effect on these. Maybe half a size over many washings, but probably not even that.

**Drying.** All of our wool is machine dryable, but after the spin cycle you can hang dry it in a 68-degree room in sixteen hours. **There are two exceptions:** The beanie, and the 100 percent wool sox. Wash them as described above, then—just one time—tumble dry on medium, until they’re nearly dr. They’ll shrink a bit and fur-up and get luscious!

**Detergentwise...**for years I’ve used and recommended either Ivory detergent, shampoo, or some kind of earth-friendly suds, and they all work. Last year we tried Kookabura wool wash, and it seems to be as good or better than anything out there, and it contains lanolin, the natural oil in wool. That seems like a healthy thing—to have your cozy wooly things sloshing around in lanolin-infused suds. How could it hurt?

Please don’t get the idea that wool—ours or any—is super delicate and requires extra special care. Clothing makers would love it if you lovingly kneaded soft gentle suds through their garments, never picked them up wet, and dried them slowly and fully supported on soft terry towels, but that’s insane. Wool’s not weak, and the sooner you get over the “fear of wrecking it,” the more you’ll wear it and enjoy it.

Your skin deserves wool. You won’t hurt it with armpit sweat or any other kind. Don’t save it for your meeting with royalty. Don’t save it, period. Wear it every day you can, and with wool’s ability to keep you comfortable in a wide range of temps, that’s bound to be almost every day. And when it’s just too hot to have anything against your skin, whip out your seersucker.

WoolyWarm is our own label of goods that are made for us, to our specifications. Sometimes the "spec" is a unique color, sometimes it's the pattern. In any case, it's not just a house-brand private-labeled, and it's always really, really good.

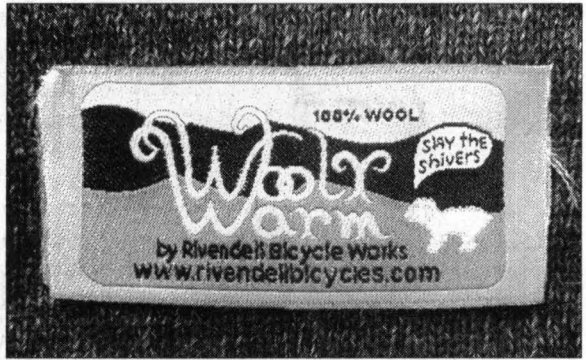

### Featherweight Sleeveless

Wear it as a first layer under a seersucker or any other dressy-type shirt, or under any of the woolies you see in this catalogue. Or you can wear it on top, and take it off mid-ride if you start to sweat too much. That's actually a good way to go, because you can strip off a layer from your torso only. A really functional system: Short-sleeve one-o-these as a base layer, then a long-sleever, then this. However you layer them, these thin-as-filo dough layers keep you warm, dry out fast, and give you tons of flexibility. The green and blue look great together.

At \$36, it's no impulse buy, but it's a thing you'll wear all year long.

Bluish S: 22-522 M: 22-523 L: 22-524  
 XL: 22-525 2XL: 22-526 Jumbo: 22-674  
 Green S: 22-504 M: 22-505 L: 22-506  
 XL: 22-507 2XL: 22-508 Jumbo: 22-675

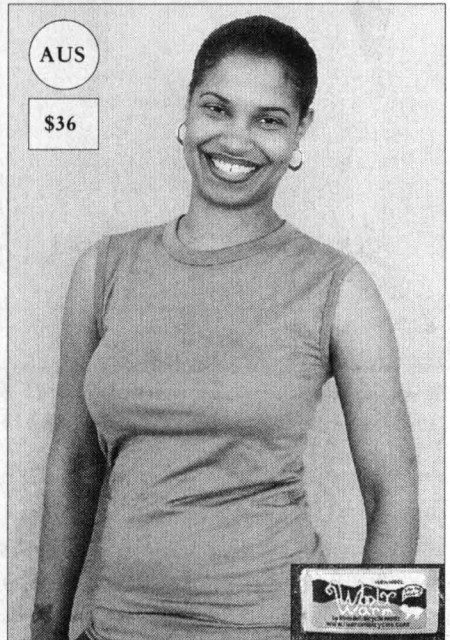

### Featherweight Shortsleeve

Same fabric as above, a superlight, smooth 100 percent merino wool. It's honestly cooler than a cotton t-shirt in hot weather, and in cold weather, of course, you're not going to be wearing cotton at all, right? Not if you exercise and sweat, at least. This is a super garment, and the practical layerist will soon find out that when he or she wears it over another garment, he or she can strip it off when he or she starts sweating or it gets too hot for him or her.

Bluish: S: 22-528 M: 22-529 L: 22-530  
 XL: 22-531 XXL: 22-532 Jumbo: 22-672

Grassy Green: S: 22-510 M: 22-511  
 L: 22-512 XL: 22-513 XXL: 22-514  
 Jumbo: 22-673



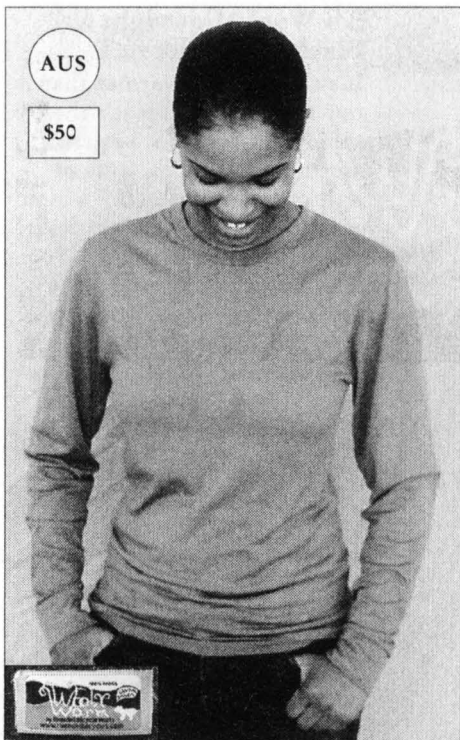

### Featherweight Longsleeve

A longsleeve version of the other shirts on these pages, and plenty useful up to about 75-degrees. You can ride in it all day long, come home at night, eat dinner in it, shower, and then use it as a pajama top. That may not be your plan, but it happens to everybody eventually, because it's a shirt that's more fun to have on than to have off.

We got it in two custom colors—grassy green and bluish grey, and they look great. It's perfect for warmer weather or layering. It's cut on the same pattern as the interlock Blacky T, but it seems to fit looser, maybe because the weave responds differently to laundering. Layer it over or under a sleeveless wooly, or with any of our other woolies. As always, it won't stink and isn't scratchy. If you like wool, you will love this shirt.

Bluish grey: S: 22-534 M: 22-535 L: 22-536 XL: 22-537 XXL: 22-538 Jumbo: 22-670

Grassy green: S: 22-516 M: 22-517 L: 22-518 XL: 22-519 XXL: 22-520 Jumbo: 22-671

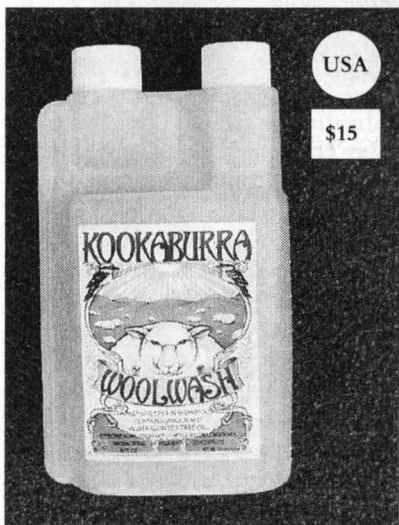

### Kookaburra Wool Wash

It's a known scientific fact that we here don't think it's all that important to launder wool with fear and delicacy. In the past we've recommended warm wash, gentle or normal cycle, and Ivory detergent, shampoo, or any earth-friendly laundry powder or liquid that doesn't boast of harsh chemicals and bleach.

Last year John here tried this stuff, and proclaimed it to be the best yet, so I tried it, and it's pretty good. It has lanolin in it, and lanolin is the oil in sheep wool and one of the World's Best moisturizers and metal protectors, and the makers of Kookaburra say it puts some of the lanolin back into the fiber. That's hard to measure, but surely it's impossible if you use stuff that doesn't have

lanolin in it, and it's not too far a stretch to imagine that sloshing around in lanolin-infused suds might put some back into, or at least onto the wool fibers. If you have lots of wool clothing and like to wash it all at the same time, try this. At worst, it'll tie for first place.

Two ounce, "curious doubter" size: 25-003 \$2

A full pound, "If John likes it, that's all I need to know" size: 25-002 \$9

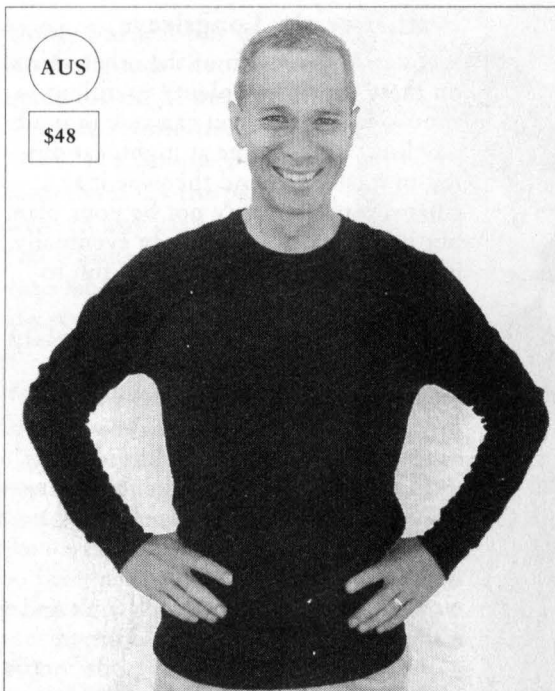

### All Wool Midweight Blacky Longsleeve T

It's thicker and warmer than our superlights, but it's the same superfine (18.5 micron) merino wool. It's a style of knit called "interlock," which costs more and wrinkles less, and keeps its shape for decades. It's fair to say that one of these makes you look richer, because of the smoothness just mentioned, and thinner than you already are, because it's black.

You can wear it under, over, or instead of a jersey. It's thin and light for layering. Off the bike, you'll wear it under normal shirts, under cotton sweat-shirts, and then at the end of the day, and even as a pajama top. It's a fantastic garment, good for everything, and in

basic, slimming black, every wool-wearer needs one.

S: 22-266 M: 22-267 L: 22-268 XL: 22-269 XXL: 22-270

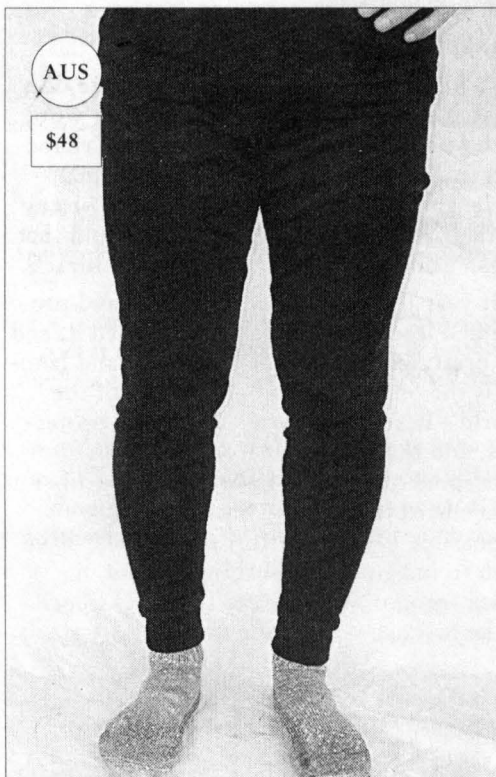

### Tights/Long Johns

When it's cold and you know it won't get warmer, tights are what you need. These are not made specifically for riding, but they lack nothing for it, and unlike riding-specific tights, they're great as long johns under regular long pants, or as pajama bottoms. Plus, since they aren't cycling-specific, they don't cost like tights, either.

These are on the light side, as tights go, and that's how we like them. You can wear one or two layers, or wear knee warmers under or on top of them. They're cozy, stretchy, not too snug, and wonderfully comfortable. It'd be hard to imagine not getting your money's worth out of these in just a couple of months of use. A good cool-weather system: Wool or Andiamo undies, then tights, then nylon baggies or MUSA shorts (on page 11). Can't beat that!

M: 22-271 L: 22-272 XL: 22-273  
XXL: 22-274

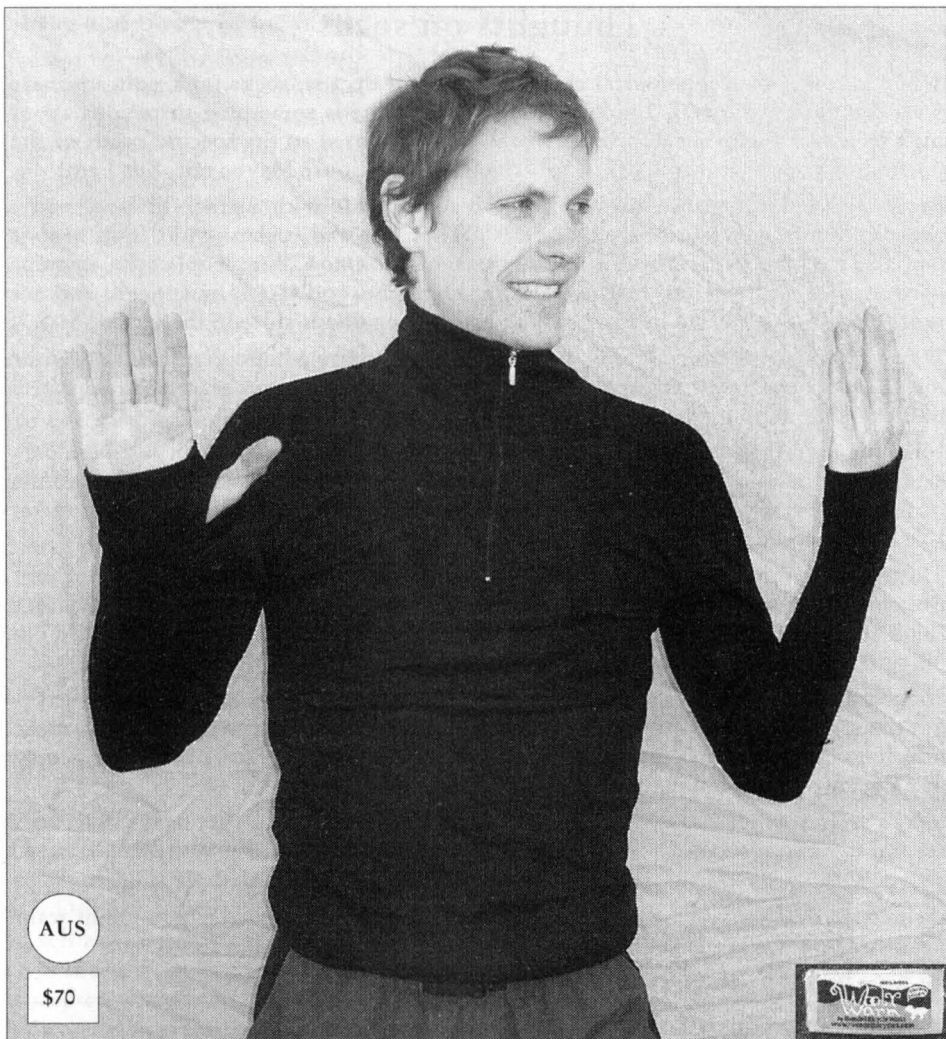

**WoollyWarm all wool Zip-T (please notice thumb holes)**

Norway's wool underwear king, Devold, recently stopped producing our favorite Devold garment, the Zip-T, in all wool. They added nylon, which is like throwing a carp in a trout creek.

Woollywarm to the rescue, with some significant help from Ktena in Australia. As an all-around cycling or general outdoor moving-about garment, it's really, really good. Zip it up to warm your neck, or zip it down for the Tom Jones look. It's just the right weight for vigorous exercise, and layers well as well.

The zipper neck lets you vent or stay warm, & the thumb holes—well, let's just say that folks who try them once generally try to cut holes in the cuffs of all of their long-sleeved garments. You don't have to use this feature, but it's a gosh-send on cool days, and you'll never wish they weren't there, those thumb-holes.

Moss: S: 22-664 M: 22-665 L: 22-666 XL: 22-267 XXL: 22-668 Jumbo: 22-669  
 Black: S: 22-658 M: 22-659 L: 22-660 XL: 22-661 XXL: 22-662 Jumbo: 22-663

Women: Buy the size stated for a loose fit, a size smaller for a snug one. If there's no smaller size and you want a similar all-wool top, call 1800-345-3918 and ask about Devold T-necks in Women's. We may have some all-woolies left.

## Thoughts on socks

When it comes to technological change in the past decade, socks rank right up there with computers, cameras, and digital music, but there is something suspicious about high tech socks with seven different zones, each tailored to the specific needs of the portion of your foot it touches. Can a thing be suspicious? Maybe not. But I am!

From a pure performance angle, high tech socks made with a pinch of wool and a shovelful of science fabrics are unbeatable. They hug and cushion your foot, keep it dry, and wear like iron. They're everywhere you look, too. Pure wool socks, in comparison, feel much better, hug enough, cushion fine, and last long enough, and are nearly impossible to find in any clothing or sporting goods store in the United States.

What's wrong with wearing out a pair of socks? If you're a hobo you may want your one pair of socks to last a year, but if you're in a sock rotation program, socks that feel like wool are more important than socks that wear like iron.

I like the idea of wearing socks whose fabric and technology haven't changed ten percent in a thousand years, and my feet don't suffer for it. My all-wool sox get me through everything I ever do with them, and I always do everything I do with them. I've never wished for less wool and more nylon or anything else.

This year, buy one pair of 100 percent wool socks and see how they go for you. Don't overthink them when you get them. Don't chart your usage. Just wear them and don't think about them, and over time they may become your favorites. That's what I'd bet on.

Socks are just about the greatest article of clothing on earth. True, you can get by without them, but pushing your foot into a nice pair of socks is always a treat. Socks make nice fun cheap gifts, too, because everybody likes a fresh new pair, and most people don't get around to buying new socks until they need them.

Here's a sock test: If you can't take your socks off without using your hands, the socks are too tight. Tight socks = no good. Socks should have some slop in them.

Some people wear their socks inside out, so the toe seam is on the outside, not next to their foot. That sounds extreme to me, but if your toes are sensitive you might want to consider it. I don't have that problem, myself, but I've heard of it. —Grant

### Socks: They're not just for feet anymore

Tip No. 1: If your wool socks come up too high, chop off the tops, then wash and dry them in the drier. They won't fray, because the wool fuzzes up and locks. Then slice a half-inch long thumb hole about an inch from the wrist, use the tops as full-wrist/partial hand-warmers. They're not the ticket for job interviews, but for cycling they work great.

Since you can still use the other part for your feet, it's almost precisely like a stupendous double-bonus!

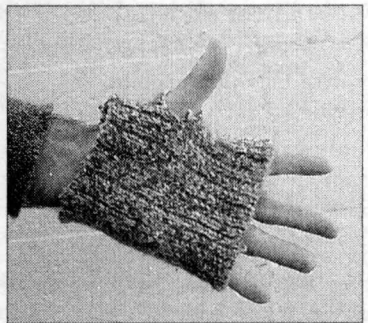

Tip No. 2: Got socks that don't fit anymore because maybe they were the kind you weren't supposed to wash, but did accidentally? Make soittens—sock-mittens. It works best when the heel has a fair amount of offset to it (think: not like a tube sock). Your thumb goes in the heel. You may not ever have to make a soitten out of a sock, but you *can* do it, so be prepared.

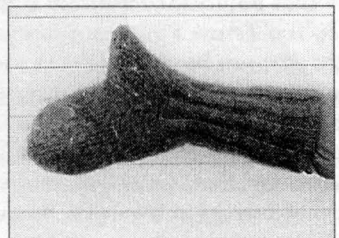

## Sheep and Sheep & Goat socks

Except for maybe some decorative indoor sox knitted in Tibet or Guatemala, you probably aren't within five hundred miles of a pair of all-wool socks (unless you're that close to Walnut Creek), because they're so hard to find. These are made in Canada, where nobody goes sockless, and the sock standards are as high as any in the world. If I had to wear one sock forever for everything, these would be them and I'd neither mutter nor utter a squawk.

They're perfect in every way. Natural grey 100% sheep wool, or natural cream, 70% sheep, 30% angora goat (not shown). No functional difference, so just go by the color you want. Wash in the machine, dry once to fuzz them up and tighten the knit, then air dry after that. Perfect! Try a pair. You will love them.

Grey all sheep M: 22-501 L: 22-502 XL: 22-503  
 Cream, 70/sheep 30/goat: M: 22-623 L: 22-624 XL: 22-625

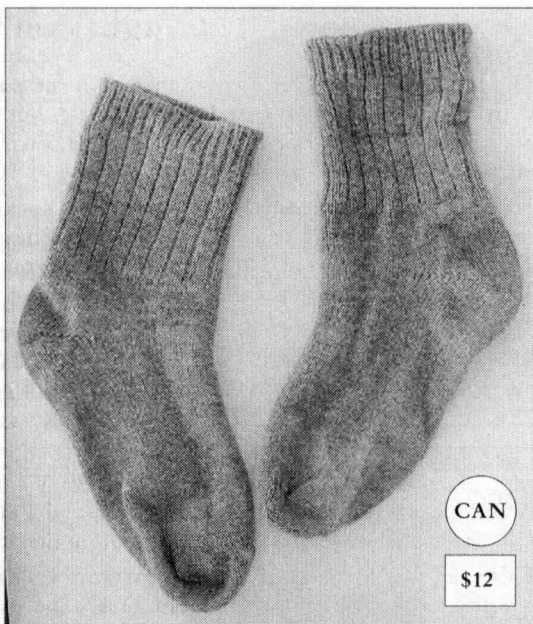

CAN

\$12

## Eightywool cycling socks

These wonderful socks are made just for us in New Zealand, by old MacDonald. The SmartWools we used to sell are fantastic socks, but these have more wool in them, and that's the trump card around here. Plus, they're a hair thicker on top of your foot, which is a plus. They're 80 percent wool, loopy on the inside, and loopier than most across the instep, so we like them extra much, and so will you, is our bet. Slightly modified since this photo was taken. Greyer, less weird.

M: 22-655 L: 22-656 XL: 22-657



NZ

\$15

## Ultra cozy women's socks

These are made for women to wear during the day, while lounging around the hearth sipping hot cocoa and watching The View, but that doesn't mean they're good only for that. They're good for any activity, inside or out, and they're the coziest socks you'll ever stuff a foot into. They're made for women, and come in one size only—women's size—but they'll fit men's feet up to about an 8 1/2.

Blue: 22-299 Mint: 22-389 Natural 22-300

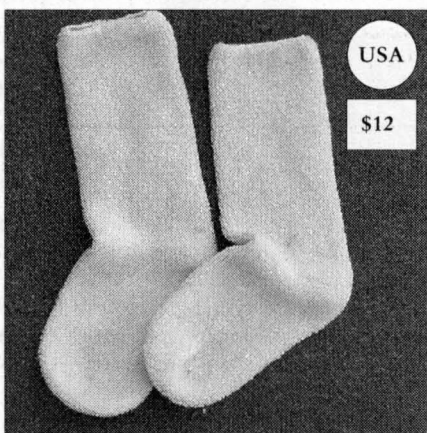

USA

\$12

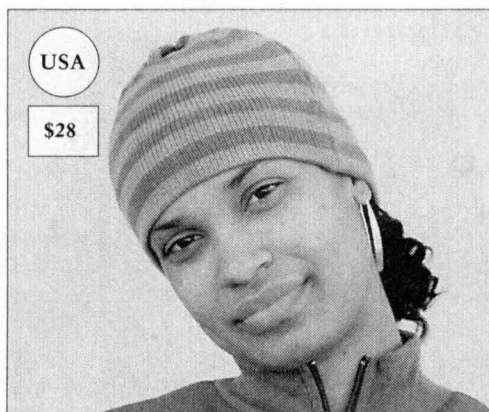

USA

\$28

### All merino wool beanie

Custom-made just for us. A bit heavier than the \$16 beanie we've sold for years—which has recently gone from all-wool to mostly wool, so we dropped it. This one is all wool with no plans to change.

Striped blue & grey. One size fits every human head on earth except for babies.

Wash it warm and dry it once, and it gets super lusciously soft.

Made by skilled Vermont women.

Blue & Grey: 22-602

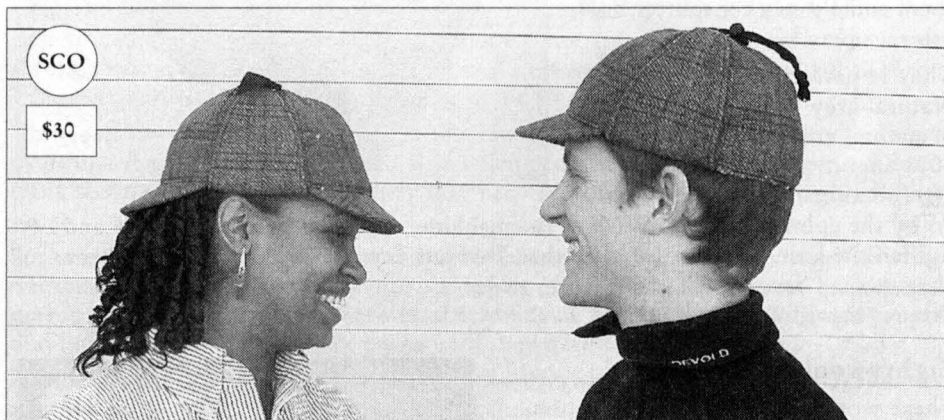

SCO

\$30

### Original Sherlock & Cycle Sherlock

Made for us in Scotland, using the same green wool tweed as the Nigel Smythe & Sons bags use. We originally ordered a few just to satisfy a lifelong lust for a genuine Sherlock Holmes hat, but that just opened the floodgates. As it turns out, the short brim in front is ideal for cycling—not too long to catch wind or block vision, but long enough to shed rain and block the sun. The original has the same brim in back, but believe it or not, some folks quake at the thought of wearing a Sherlock Holmes hat in public when they're not strolling about in London or \_\_\_\_\_ (fill in your favorite famous town in Scotland). So we also stock a one-brim version, which is quite a bit of a lower psychological hurdle. In both hats, the earflaps turn down to warm your ears, silence the wind as it roars past your ears, and keep your hat on no matter what. Truly a fine hat. It fits under a helmet, by the way. Green all-wool plaid.

Original Sherlock: M (to 7 1/8): 22-576 L (to 7 3/8): 22-577 XL (to 7 5/8): 22-578

Cycler Sherlock: M (to 7 1/8): 22-620 L (to 7 3/8): 22-621 XL (to 7 5/8): 22-622

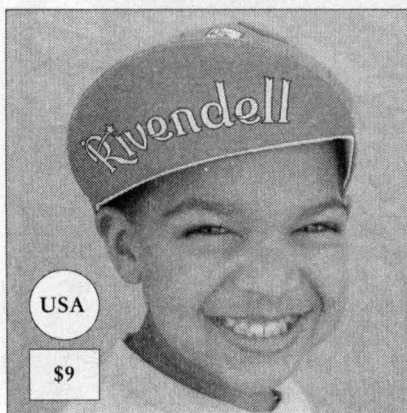

USA

\$9

### Cycling Cap

100 percent cotton, made in the USA.

These fit large American heads better than the European caps do, but they're still not right for my/Grant's head, so I always cut out the crown and make visors out of them. Then they fit under a helmet nicely. If you're less of a fathead, just wear it like a hat. The color changes every 144 caps we sell. We take turns picking the new color, so the current color will vary.

Cycling Cap: 24-066 \$9

### All merino wool sweatband

Surprise, surprise: In February '05 wool took home yet another ultra-gold medal connected to a blue ribbon—this time, in the prestigious Sweat Band category.

Cotton gets wet and stays that way, and wicking wonder fabrics hold no moisture and stink. Our woolly sweat band holds lots of sweat without dripping, and when it gets saturated, you ring it out and use it again immediately. Take that, science man! Wool rules the forehead.

Assorted colors, it's only a sweat band.

Wool sweat band: 22-154

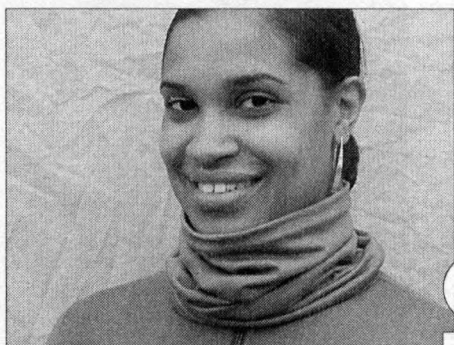
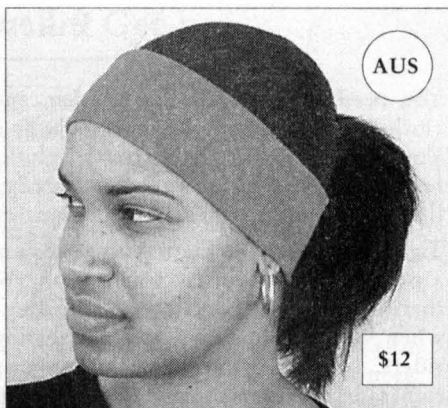

### All wool Triple-Tube

Wear it as a beanie, a neck gaiter, or become a periscope and gaze through the face hole. Grab bag colors keep the price low and delivery good, and they all look good!

It's a pretty neat thing, and you can do a lot with it. If you ride a bike, hike, or just loiter on the street in the cold, bring it along and you'll find a use for it. You just can't beat it for versatility. Have three or four around, and go nuts.

Triple tube: 22-689

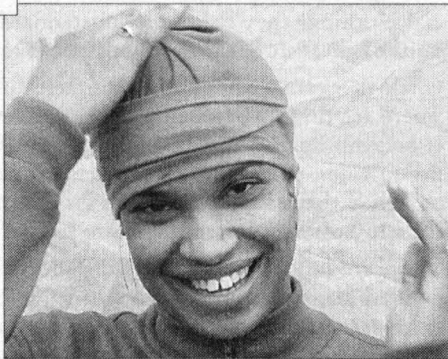
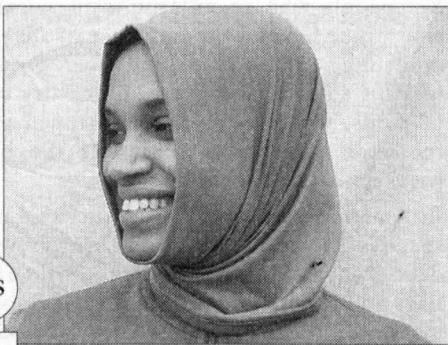

### Thin wool Norwegian balaclava, or perhaps Australian

Made in Norway or Australia. We have both. Thin but not too thin, it'll go under a helmet easily. It's long enough to protect your whole neck, too. It's so light and packs so small, you might as well bring it along. You won't go any slower for it, and it might keep your face and ears from freezing. You can wear it as a beanie, too, and you can wear it under a beanie, and over or under the triple tube. Layer up with wool—that's the way! Grab bag colors.

Some nice color!: 22-599



## Bike Clothing

You need to dress for the weather, and you need clothes that don't restrict movement or irritate you. You can wear skin-tight & stretchy clothes, like professional bike racers wear for aerodynamics and flash, or normal clothes, like you wear every day.

Tight and stretchy is the way to go if you want to set a personal record on a certain loop you ride, and there's a lot of flat and downhill riding in it. Also, when you're riding as a group, dressing like other riders, in tight & stretchy clothes, can encourage camaraderie and make you feel part of a gang. On the other hand, dressing your own way shouldn't get you ostracized.

But people who go on around-the-world trips and ride a bike beyond the influence of advertising, role modeling, sponsorship, and peer groups end up wearing some kind of loose, quick-dry baggy shorts or pants, whatever shirt they happen to have, and footwear that makes sense off the bike—boots, sneakers, sandals, or whatever.

In America, cyclers who are otherwise normal wear spandex shorts and skin tight jerseys with psychedelic geckos, skulls & crossbones, wilderness murals, flags and serious-looking bald eagles, and advertisements for the local coffee shop or podiatrist. The message it sends potential riders is that without special clothing, they'll have a substandard experience on the bike, but of course that's not true.

Click-in cycling shoes are a miracle of marketing. There are times when being that joined to the pedals is helpful. Racing and all-out efforts in wet weather group rides, for example. For general riding, though, double-sided pedals and almost any shoe that's lightish and has a rubbery sole works fine. Teva Hurricane sandals are hard to beat, but in fact there are tons of non-cycling shoes that work well.

There are lots of "casual" cycling shorts out there, and it seems they all have a sewn-in padded diaper, maybe to justify the "cycling" category. Light padding is desirable and seamlessness is good too, but it's better to not have a padded liner sewn in. When your pants are separate from your undies, you can change undies daily and keep wearing the same pants or shorts, until they need a washing, too.

Sometime try riding a bike in normal clothes. If you do it often enough, you'll weed out certain garments, but in short order you'll find that your cycling wardrobe is about five times as big as you thought it was, and you'll never again not go for a short ride just because you didn't feel like suiting up.

We sell bike jerseys, and like them and wear them ourselves, when it's appropriate or we just feel like it. The rear pockets are handy, but not essential, and a bag on a bike almost always carries whatever the pocket can carry, and does it better. Pockets are for getting at stuff while pedaling a bike that has no bags. Or, if you're just going out for a short ride, a snack and a repair kit fit nicely in jersey pockets. Jerseys are good, but you don't have to wear one all the time.

Starting now, we have our own line of bike clothing that doesn't look like bike clothing, but works great for riding. It's MUSA, and MUSA stands for Made In the U.S.A. So far the MUSA collection includes two tops and three bottoms that are perfect for the cycling conditions for which they were designed, and don't tag you as a cyclist when you're not around a bike. We'll add to the MUSA range slowly as finances allow and there seems to be a need. —Grant

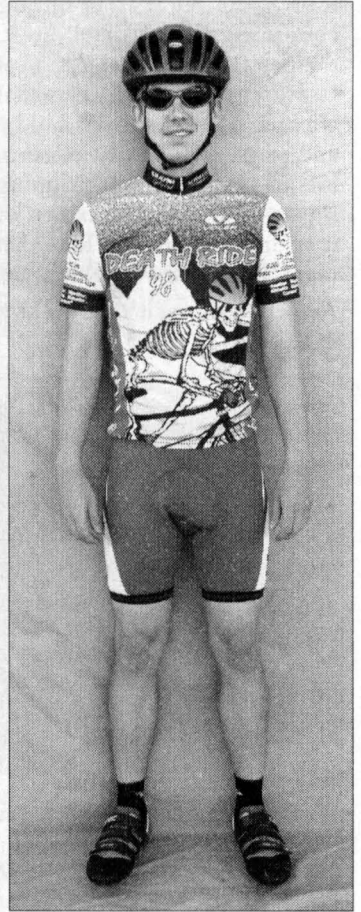



## A Good Hot-weather Get-up

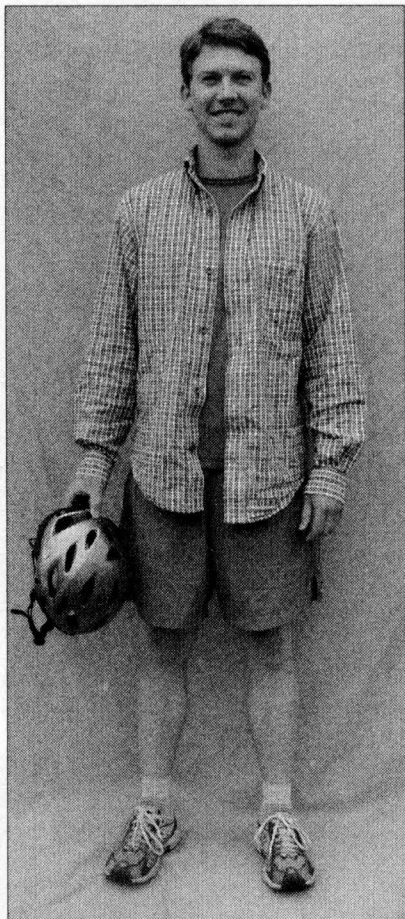

### <---- skull and eyeball protection

These & everything else here are personal choices. It's too bad these safety things give you an alien look and prevent eye contact with motorists and other riders, though.

### <---- longsleeved seersucker

Keeps the sun off, doesn't lay on your skin, and flaps to cool you. Collar protects neck, too, and can be turned up for Gobi-desert riding.

### <---- light sleeveless wool undershirt

Lets you unbutton the seersucker without your gut hanging out, protects against chill, and won't overheat you in hot weather, really.

### <---- quick-dry baggies

With separate padded liners (like Andiamos or wool undies). This way, you won't feel so weird if you have to go inside a store to get some food, or mingle with non-cyclers.

### <---- cushioned wool sox, normal shoes

Sox should be absorbent & cozier than thin tighties. Sneakers or Teva-type sandals work fine, especially if you ride step-on pedals.

**Tops:** Tight shirts get heated by the sun, and then you have hot fabric on your skin. Our favorite hot-weather shirt is a loose, floppy, long-sleeved seersucker. Summer tip: Rit Sun Guard. Add it in the wash with your regular clothes, and it adds SPF 30 that lasts for twenty-four washings. It costs \$5 and is sold next to Rit dye.

**Under the top:** If it's not too hot out, wear a short-sleeved or long-sleeved wool shirt under a cotton seersucker. That way, you can unbutton the seersucker and get extra ventilation, without exposing your alabaster torso to the blazing sun.

**Undies:** Andiamos weigh nothing, breathe well, and are seamless and slightly padded. The all wool lightweights are remarkable as well, and if you give them a try, you may find it hard to use anything else. They're really good.

**Bottoms:** Shorts, knickers, or long pants, whatever the weather or bug situation dictates. Any of the superlight, brushed nylon knockabout-style pants, usually sold for water people, or climbers, will do fine. The crotch seams are no big deal. (MUSA bottoms have no crotch seams, if that matters.)

**Socks:** There isn't a sock made that isn't suitable for cycling, but you'll do well to avoid thin cotton for rides of 3-hours plus.

**Shoes:** There are lots of casual cycling shoes out there. They all work well, as do dozens of sandals and sneaker-type shoes. There are more that work than don't. The Teva Hurricane, Adidas Samba Millenium, Puma Roma...lots of goodies out there. And guess what? You can walk around in them, too, and they don't have that "foot SUV" look, like mountain-biker-hiker shoes do. That's not a terrible look, I'm just saying these other shoes don't look like that.

## MUSA: Cycling clothing M.ade in the U.S.A.

If you've breathed during the past ten years, you've noticed that clothing that used to be made here isn't anymore. Even iconic American marques such as Woolrich, Lee, Levi, Columbia Sportswear, Pendleton, and *Filson*, for crying out loud, are farming out garments to distant lands specializing in neat seams & cheap labor.

The clothes made there are usually every bit as good as the ones they replaced here, and sometimes better. They cost much less to make, help boost the economy of the lands they're sewn in, and improve the living conditions of the workers who sew them. But in the process tens of thousands of stitchery people have lost their life's work.

Those in favor of sending the work to China use the argument that the displaced workers can go back to school to learn skills that will help them get better jobs. That sounds good & is easy for an unaffected person to say, but there are more job applicants for jobs that require college degrees than there are jobs that require degrees. Job growth is on the other end, and those are the jobs being sent overseas.

It's one thing to buy wool clothing from Australia or New Zealand or Scotland or England, where all the sheep are, or from Norway, where the maker has been making wool underwear since 1853. We go to these places not for cheap labor, but despite their expensive labor, because they are so good at what they do, and nobody here is doing their particular thing as well. Especially now.

But it's different when you buy an American-styled anything that has no connection to the Northern China factory where it is sewn, especially when sourcing it there creates out-of-work here.

As a small company with a tiny home label (MUSA) that makes a minimal contribution to our bottom line, it's easy for us to sit on a high horse and wag fingers at big companies whose bread & butter is clothing, and who have to take their business to China or wherever to get the prices they need to compete in their market. Plus, America's at the point now, clothing-makingwise, where there are just too few high-volume options here anymore. If they didn't go to China, they wouldn't have a business, and more Americans here would lose their jobs. So, when you hear the globalization-advocates say that it creates jobs here, they're partly right. It's complicated and beyond the scope of this measly catalogue.

But we're proud as can be of MUSA clothing. It's made here and it works.

No matter what you like, MUSA duds are a fine alternative at least, and their familiar look and casualness belie how well they work for cycling.

Seersucker has the handicap of a funny name, and has been joked about for years—largely because of its name and for east-coast dandies who wear full suits of it under white straw hats to summer picnics. Forget about that. Ours doesn't look funny, and is hands-down the best hot-weather cycling top I've ever worn.

The shorts, knickers, and pants are just as good. They're superlight textured nylon, and are quick-drying, good-looking, and cut for movement. The knickers are new this year, and won't be available until June 29. We're taking backorders, so order up if you want to make sure you get yours. We won't charge until we ship.

MUSA colors: Butternut is like a darkish walnut or khaki; a rich, deep, beautiful golden brown, quite uppercrusty. Grey is dark grey, charcoal-like. The olive accents are olive, and they go well with the butternut and grey.

You can see the colors on our site: [www.rivbike.com](http://www.rivbike.com).

### MUSA Sizing

**Shorts:** The legs are baggy, so if your thighs are small and you like your shorts tight, you won't like them. **Pants & knickers:** Baggy legs still, but not as obvious, because they're pants...or knickers.

**Shorts and pants waists:** S: 30-32 / M: 33-34 / L: 35-36 / XL: 37-39 2X & 3X: bigger

**Seersucker shirt:** Cut full, with long arms. Get your normal shirt size.



Tetsuya Ishigaki, head builder at the six-person Toyo frame shop in Osaka that builds the Atlantis, Rambouillet, Romulus, Glorius, Wilbury, and Saluki...forgot his helmet, lost our loaner, loves his seersucker, won't give it up.

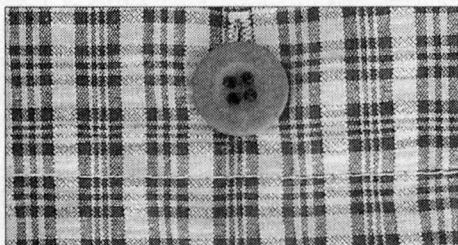
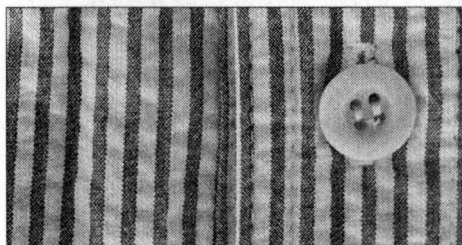

### MUSA Seersucker

When it's pure hot outside and you're on your bike getting blasted by the sun, there is nothing better to wear than this all-cotton seersucker. The puckery fabric doesn't lay on you like non-seersucker fabric does, so you get better ventilation, and the patterned fabric hides your sweat. The long sleeves shade and protect your arms from the sun. Wear it over bare skin or over a sleeveless wooly, which means you can even ride with it unbuttoned.

Detailed properly, with a collar copied from a Brooks Brothers shirt; and a fruit loop in back, a full buttoned placket, nice cuffs, & special buttons. You'll like wearing it on or off the bike, tucked in or hanging out. It looks fine then, too.

Each shirt costs us \$30 plus development (\$1,000+) plus freight. If it were sold at normal clothing margins for regular clothing sellers, it would cost \$65 to \$80. For \$47, expensive fabric, nice details, no corners cut, it's a bargain, and is easily the nicest long-sleeved seersucker you'll find anywhere.

We try to stock two patterns: a blue & green plaid over white, and a cream & grey stripe. At any given time we may be out of one in your size, but we'll do what we can to keep good stock. For actual colors, go to our website: [rivbike.com](http://rivbike.com).

Blue & green plaid: S: 22-437 M: 22-438 L: 22-439 XL: 22-440 2XL: 22-441 \$47

Cream & grey stripe: S: 22-559 M: 22-560 L: 22-561 XL: 22-562 2XL: 22-563 \$47

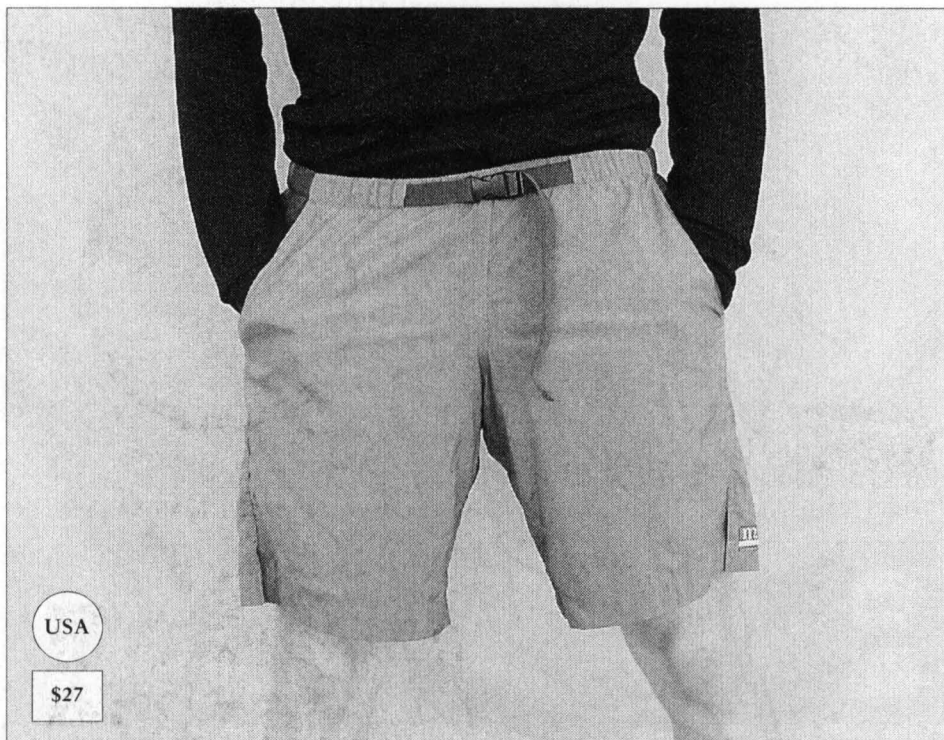

The legs are wide. The elastic belt is way longer than it needs to be, and easily removed. Two big front pockets, and two buttoned rear ones.

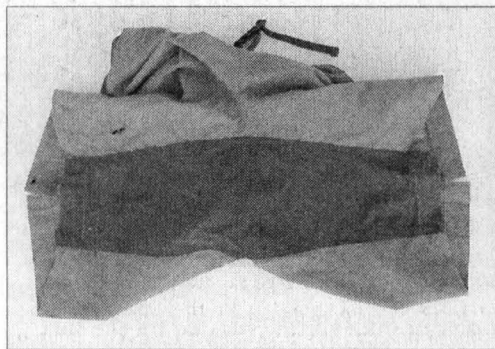

Seamless crotch for heavenly comfort. On both the butternut (formerly “dark khaki”) and grey, the contrasting color is olive, and it looks great. Don’t worry about walking around looking funny because the crotch is a different color. It isn’t noticeable at all. It just makes them look a hair less boring.

## MUSA Shorts

The best all-around riding shorts we’ve used, and they’re normal-looking off the bike, too. Featherweight brushed nylon, seamless crotch, big pockets, separate belt you can take out or leave in, and thankfully no sewn-in liner. Wear Andiamo or wool undies instead—it’s more comfortable that way, with no “full diaper” feeling, and it only makes sense to wash your underwear separately from and more often than you wash your outer pants. Cut full and on the long side. Good leg movement, fast drying, one great two color combo: butternut with olive accents at the crotch and pockets. It does not look foolishly sporty, the way accents sometime do. Ours are low-key & good.

The cut is full, the legs are wide. You don’t have to buy up a size. If anything, down. Two pairs of these cost less than a typical pair of bike shorts, and these shorts are more useful & comfortable on several levels. The only reason you might not like these is if you have really skinny legs. We might do an SL version later, but for now, this “widish” leg version is all we’ve got, and it works for most people.

Butternut/olive XS: 22-442 S: 22-443 M: 22-444 L: 22-445 XL: 22-446 \$27



Tetsu Ishigaki in an unfortunate choice of shoes, pedaling up Mt. Diablo in MUSA pants.

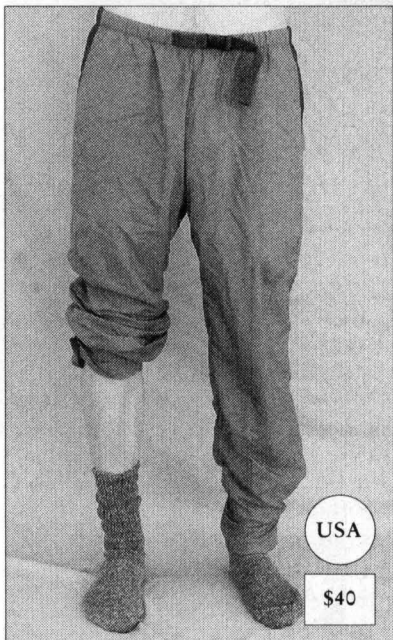

Even though we have knickers, you can knickerize the pants, like this. The knickers aren't as bunched as this.

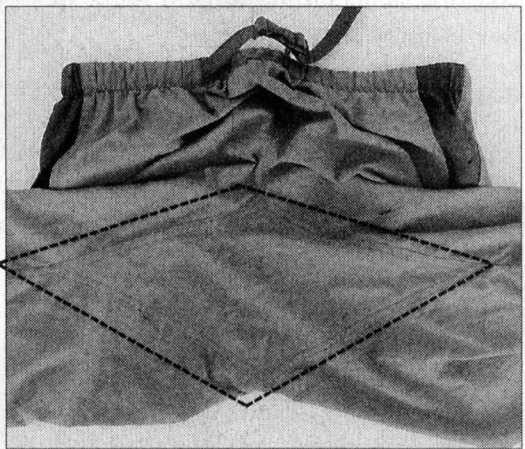

This seamless, gusseted crotch probably isn't necessary with fabric this light, but if we didn't have it there, some folks would balk. In any case, these are as comfortable as anything you can ride in. We will go to a dark green crotch on future productions. It looks good and rather sporty with both colors, and it's good to have a dark crotch on which to wipe greasy fingers. If you order early, you may get non-contrasting crotch. It's not better or worse. Be flexible and happy with either!

### MUSA Pants & Knickers — \$40 each

The **pants** are dreamy to ride in and handsome enough to wear just about anywhere. They pack small, weigh nothing, and they're comfortable in temperatures up to about 90-degrees. If they get soaked by rain, as soon as it stops they'll dry so fast your head will spin. Cut full through the thigh, tapered below the knee, and there's a velcro tab at the ankle for snugging them out of the chainring's way.

The **knickers** are shorter, and even though you can knickerize the pants by hiking them up and snugging the strap above your calf, if you do that a lot, you might as well get the knickers right off the bat. Plus, with the knickers, you can not hike them up and still get more air to your leg. Howzabout *that*? Butternut (formerly "dark khaki," but the fabric maker's name is butternut so we're going that way now). With olive pockets and accents. They look good that way.

Pants— B-nut/olive S: 22-433 M: 22-434 L: 22-435 XL: 22-436 2X: 22-653 3X: 22-654  
 Knickers—B-nut/olive S: 22-631 M: 22-632 L: 22-633 XL: 22-634 2XL: 22-635

## Kucharik Short-sleeve Jerseys

*All wool, and made in California since 1934.*

Kucharik has been making bike clothing in southern California since 1934, and the Kuchariks still run the show there. Kucharik jerseys are exceptionally well-made of merino wool, and except for the Tom Jones zipper have traditional styling and details. The cut is fuller than most European brands are, so you needn't be a whippet to fit one. Still, if you have any doubts, buy up, not down. Shrinkage is minimal. You'll get 500 rides out of these, which comes to \$0.17 per ride. We did the math on a calculator, so you can take that number to the bank.

Royal blue S: 22-457 M:22-458

L: 22-459 XL: 22-460 XXL: 22-461

Red S: 22-462 M:22-463

L: 22-464 XL: 22-465 XXL: 22-466

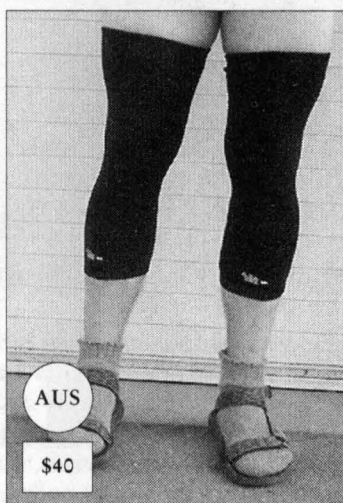
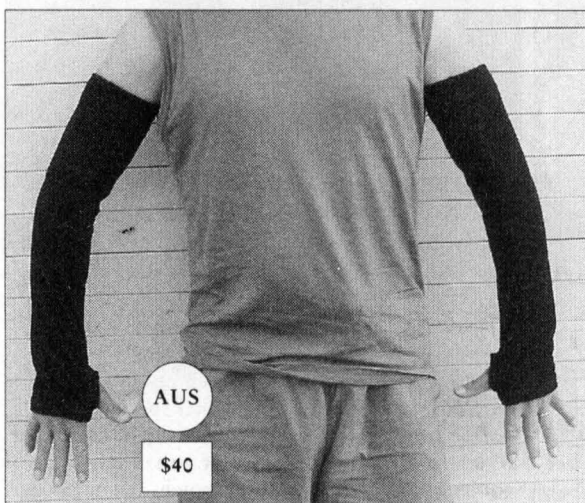
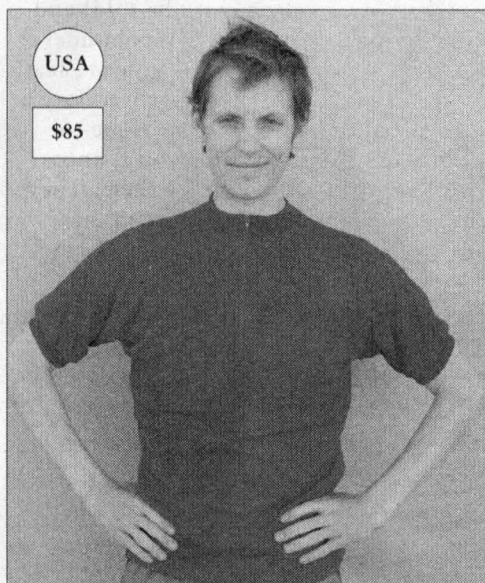

## Wooly Warm Arm & Knee Warmers

Warmers are good because if you start out with them and it gets too hot, you can stuff them easily anywhere. Ours are 100 percent merino wool, made just for us, and made in Australia.

The arm warmers are looser than most, because loose feels good, and they won't slip down, because there's sufficient elastic up top. And they have thumb-cuffs, something all arm warmers could benefit by, but we got 'em first.

The knee warmers are long and snugger. Long, so you can pull them high and still look like you're just wearing knickers if you've got black shorts on. And snuggish, because the last thing you want is sagging knee warmers. As knee warmers go, ours take the cake for length. Look how long they are. They're practically leg warmers, and in knee warmers, that's good.

Black arm warmers S/M: 22-330 L/XL: 22-331 Available after June 20.

Black knee warmers S/M: 22-308 L/XL: 22-309

## 100 percent merino wool Norwegian skivvies, by Devold

The Norse are a cagey yet perceptive people (sharp as a tack, if truth be told) and Norskthought goes thusly: Wool underwear makes you immortal. These are featherweight, soft, slightly supportive, have a seamless crotch, and are easy as pie to wash. Wear them once and you'll know why Thor & Helga swear by them. They truly are the most comfortable undies you'll ever don, and will surely become your secret weapon against death.

Dark grey. If Devold stops making these in 100 percent wool, we'll get them from Australia. Those will be black. Women note: If you don't buy these, we're dropping Womens from the next catalogue. If you try them, you will like them.

Mens: S: 22-606 M: 22-607 L: 22-608 XL: 22-609 XXL: 22-610

Womens: XS: 22-611 S: 22-612 M: 22-613 L: 22-614 XL: 22-615

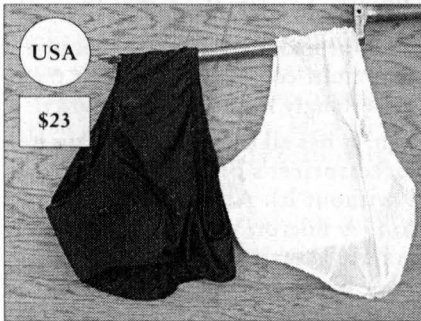

## Andiamos 100 percent synthetic skivvies, from Idaho

The original fast-drying seamless padded soft synthetic panty liner, perfect under MUSA bottoms or any others. We used to stock just the briefs, but some people like the long ones that look just like bike shorts. On a hot day in a pinch, you could probably get by unarrested with them (the longs, not the briefs).

Briefs: Men's, white: M: 22-301 L: 22-302 XL: 22-303 \$23

Women's, black: S: 22-305 M: 22-306 L: 22-307 \$23

Longs: Men's black: M: 22-627 L: 22-628 XL: 22-629 XXL: 22-630 \$24



## San Franciscan suspenders

Pedaling in a riding position may tend to pull your pants down. It all depends on how low you wear them in the first place, and how skinny or fat you are, but it can happen to mediums, too. Plan accordingly by wearing these blue suspenders, which Walter sews in San Francisco. They're a bargain for \$11, and one adjustable size fits everybody except tots. A nice royal blue with harmless teeth in the clips. Elastic.

Walter's Blue Y-back suspenders: 22-391

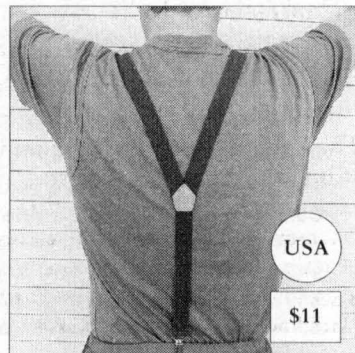

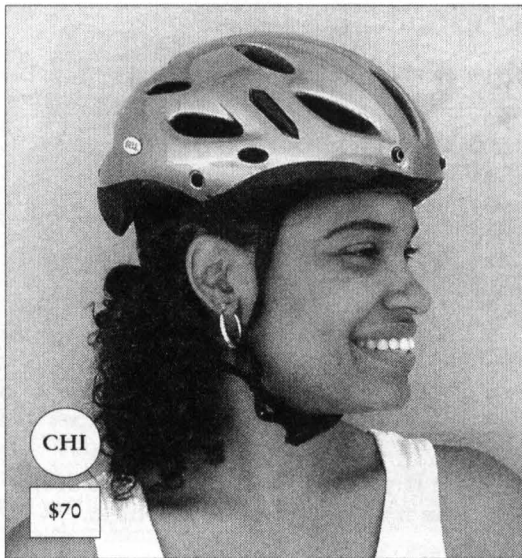

## Bike helmets in general and the Bell Metro in particular

Helmets can save your life, *but* they can give you a feeling of invulnerability that makes you ride more recklessly than you would if you didn't wear one at all. This phenomenon is called "risk compensation," and affects many people—in a variety of fields—who wear safety gear. It may be one reason motorists who drive around elevated and cushioned in a big car or truck in a sea of traffic on the freeway tend to drive faster and take more chances than they would in a rickety jalopy.

We all know of people who've been saved by helmets, and maybe you're one of them. A good percentage of those who have been saved tell the "what if" stories over and over again. Once to your close friends is enough, though. We've heard enough for several lifetimes.

Helmets are good, though, and bless Bell most of all for making the Metro, because it lacks fins, flames, and fanciness of any sort. It's not multi-colored, and doesn't try to look like it's moving when it's standing still. It's refreshingly round, but not dorky.

It's a far cry from the classic coconut shell, though. It has all the safety features helmets must have, and beyond that, it's a helmet accessorizer's dream. It comes with a visor (not shown above, since it looks better without it). And you can buy lots of extras for it to suit your taste and the season: A mirror, which unfortunately mounts only to the visor. (If your morning commute is eastward, use the visor). A red blinky for the back of the helmet. A rain cover with reflective stripes. And for cold weather, neat ear-warmers.

The Metro comes in four colors, but we stock only "titanium," a greyish one, as shown. Medium fits to 7 3/8. Large, to 7 3/8 to 7 3/4.

Medium Metro: 31-246      Large Metro: 31-427

**Bell Metro Accessories** Blinky light: 31-385 \$8      Visor Mirror: 31-430 \$8

### RISK COMPENSATION

Risk compensation is the halfway semi-subconscious phenomenon of behaving dangerously because you think your gear or clothing will protect you. A parachute-packing skydiver or a tank-toting scuba diver are obvious examples, but risk compensation affects hikers, climbers, sunbathers, surgeons, firefighters, HAZMAT workers, skiers, motorists in large-quiet-cushy vehicles, and cyclists. When you don a crash helmet, you're likely to feel safer so you take more risks. **If you ride differently with a helmet on than you'd ride without it, you are risk-compensating. If you ride in traffic with a helmet when you wouldn't without it, or bazoom down the hill faster because you're wearing a helmet, you're risk-compensating. A certain amount of risk compensation inevitable.**

Modern bike helmets are well-vented styrofoam covered with thin plastic skins. Compare them to motorcycle helmets and football helmets. Few cyclers would wear such clunky helmets, so bike helmet makers focus on style, light weight, and venting, and as a result, your \$179 bike helmet isn't nearly as protective. In any head-hitting accident it's better than nothing, but don't overestimate its ability to save your brain in a hard fall, and try not to risk-compensate.



## Bags for Bicyclers

*From America and England*



The obvious purpose of a bag is to carry something and give you access to it. Modern black nylon luggage excels at that, especially the access part, but it looks cold and tacky, cheap and lousy, even when it's not necessarily. But everywhere you look there are all-black nylon bags with zippers, velcro, mesh, plastic buckles, and compartments. No need for another one!

Beyond price and availability and the fact that you don't have to sweat if it falls into a grease puddle, it's hard to get worked up about that kind of a bag.

But when a bag is made with the best quality natural materials and metal, it feels good, looks great, works as well, and lasts longer, and is easy to get worked up about.

We offer two lines of bags —Baggins, from the U.S.A., and Nigel Smythe & Sons, from England.

Baggins bags are no frills, no nonsense, rugged and manly. They're our own designs based on years of commuting, day-riding, camping, and touring with bags of all sorts. They are simple by design, and, arguably, simple to a fault. For instance, the saddlebags are designed to give you options on how you want to close them up, and options call for a smidgen of creativity. Some folks would rather not have options, but others will find the options let them rig the closing method according to the load size, shape, or their personal style or security paranoia. Finish- and detail-wise, the Baggins bags are sewn neat and strongly, but lack the finishing touches

of a fine lady's purse. That's appropriate, since they're made for outdoor use.

The Smythe bags are over-the-top tidy, with an upper-crust look that suggests they're all show and no go, but in fact, they are just as much go as show. They're wool on the outside; twill on the inside, with a waterproof rubberized laminate in between; and they're stitched neat and strong.

Some folks have balked, saying, "They're too pretty to use." Don't be a sissy—use them hard! These are strong bags, and look better with signs of use.

In wet weather, use bag covers on them. The fabric itself is waterproof because of the rubber laminate between the layers of cotton twill, but as with any stitched bag, seams can leak. The covers are superlight and just keep them in the bags. The covers are slight—they go on and off easily, and provide good access with minimal hassles. We'll have final designs by May 10, and covers in stock (and cheap) by June 30 or so.

The right bags make bikes ready for anything. You can carry food and spare clothing, so you don't have to wear the warm stuff on the way up just so you'll have it on the way down...or wear a windbreaker now just because you'll be wanting it in an hour.

Bags on your bike let you ride in any shirt, bring any food, even take a camera and binoculars. I see riders all the time riding racing bikes and carrying high-tech water-bladder packs with extra clothing and food in them. They'd be better off with a bag or two.—GP



### Hoss

The Hoss is about as big as a saddlebag can get, and ought to be your choice for overnights or any kind of touring or commuting when the load is just a bit less than humongous and you don't want to carry panniers. It carries a big and heavy load amazingly well, and once you get over the initial feeling of pedaling with 20 pounds in a saddlebag, you'll soon forget it's even on there.

If you're after a simple-to-use, large capacity saddlebag for self-contained trips,

the Hoss is the best choice in the world, by a good margin. It doesn't need a support, but works better with one. Get Mark's rack 20-108 or 20-095, or the Silver Hupe (#20-136, page 36).

The Baggins Hoss: 20-078 \$170



### Adam

Our most popular big bag, because our claims about the Hoss's hugeness tend to scare folks off. For anything other than camping and pannier-substitution, you're unlikely to max-out the capacity of the Adam. And if you do, you can always tie extra gear on top, using the handy rings that are sewn onto the flap. If you can get only one saddlebag, this is the size to get.

The Baggins Adam: 20-079 \$170

### Saddlebag Support, or No?

Yes. You can mount any of our saddlebags direct to the saddle and seat post, but a Country bag, Hoss, Adam, or any of the larger Carradice saddlebags benefits from a support. The support stabilizes your load, prevents it from sagging, helps the bag sit better. Our choices, in any order, are 20-094 (top rack); 20-095 (top rack with side supports), 20-108 (Mark's rack), and 20-136 (silver hupe).

### Saddlebag Care

Goop up the leather trim with Obenauf's once a year, and that's about it. They shouldn't be stored wet for long periods, but in general, they're rugged bags that don't need babying. In time you may wear one out, but maybe not.



### Baggins Banana Bag

*The best, most useful, and easiest to use small day bag on Earth.*

It's shaped roughly like a fat banana or paisley, wider at the top than at the bottom. You can pack it any way you like, and it always seems right. The top closes with a brass roller buckle, and opens upward, so the load stays in place while you're digging around in it. The wide-mouth makes it easy to find what you're looking for, and it's easy to pack back up, mainly because there's no zipper to fight with.

Member and Professor Benson Tongue mounts one on the front of his handlebars, around the stem. There it serves as a camera bag, suitable for anything up to a small 35mm camera and a zoom lens. The Baggins Banana is the best small seat bag you'll ever use, and by far our most popular model. We sell about 300 of them per year (one year, 444). It's a good one!

Banana Bag: 20-082 \$88

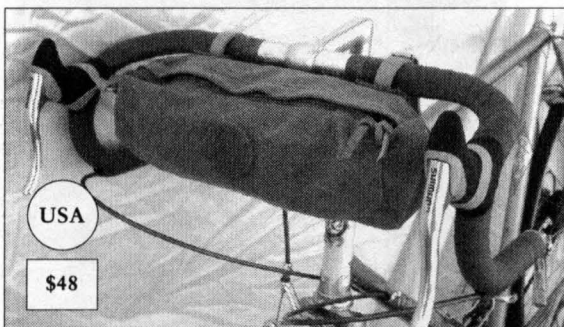

### Baggins Candy Bar Bag

A super simple bag that's easy to mount & carries snacks, gloves, wallet, keys, pocket camera and another thin layer. It's greyish brown with thick leather trim and a 2-way tooth zipper. Quick on and off. Magnificent bag!

Candy Bar Bag: 20-085 \$48

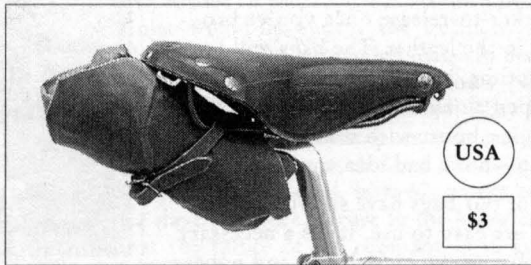
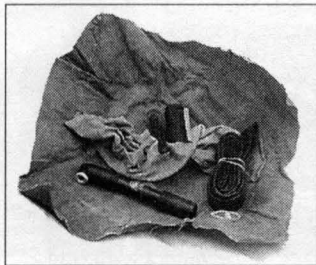

### Our \$3 Burrito Wrap

It's an 18 x 18-inch square of stout, unhemmed, waterproofed cotton, and for compact and minimal loads, it is the best carrier on Earth.

When you get a flat, lay it out on the ground like a place mat. All your tools are there, and won't get lost. When finished, wrap them up again like a burrito, and secure it to your seat rails or seat stays, using a toe strap. You can't make it yourself for this cheap. We've sold this for 11 years and for \$3, everybody should have one. You can use it inside a bigger bag, if you like, Instructions included, toe strap not.

Burrito Wrap: 20-003 \$3

## Saddlebag fabric, leather, hardware, & rigging

BAGGINS BAGS are made of 16oz, dark greyish brown, waxed cotton duck. It's rugged and for all practical purposes waterproof. When it gets old and cold it gets stiff. The leather is lighter brown, and it's common for a bag to have leather trim that's a slightly different shade of brown than are the straps (and vice versa, thank goodness!). The stitching is strong and fairly neat, though not as neat as the stitching on a \$280 woman's purse. The overall look is neat but rugged. The solid brass hardware will outlast you and everybody you know.

THE NIGEL SMYTHE & SONS bags are the spiffiest, most uppercrusty outdoor bags of any kind we've seen. Some folks think they're too good-looking, or even too sissy-looking, to use hard. They aren't! The fabric is a 3-layer laminate of 100 percent wool tweed, rubber (for waterproofness) and cotton twill. It doesn't repel rain the same way a waxed fabric does, but it looks newer longer because it's not waxy. The waxed Baggins bags work better in soaking rains, but the Smythe bags keep your contents dry enough, and after June 20 we'll have bag bonnets cheap for all the models. This will make them the most stormproof bags yet.

The Smythe leather is everything you'd expect on a high-class bag from the land of Queen Elizabeth. It is uniform in thickness & color, a golden blond, just a bit lighter than a brand-new Rawlings Heart of the Hide baseball glove. It has smooth edges an gives the impression that its cow lived a coddled life. They didn't chintz-out on the hardware, either; it is chunky solid brass. Many of the buckles on the Smythe bags have quick-release buttons, which are quicker-to-release once you've broken in the leather. The bags will last a long time, and the breaking-in will happen along the way, faster if you give it a boost with some leather goop—not a bad idea, anyway.

All of our bags have simple designs and are easy to use. If it's a necessary feature, we've included it, and nobags has any secret compartments just to show off.

The transverse-style saddlebags, like the Country and Hoss and Adam and various models from Carradice of England, are easy to attach to the saddle if it has loops, and the seat post. Sometime, to optimize the connection, or to make it more to your own taste, you have to get creative. That's just the way it is. —Grant

### One of many ways to rig a Nigel Smyth Country Bag

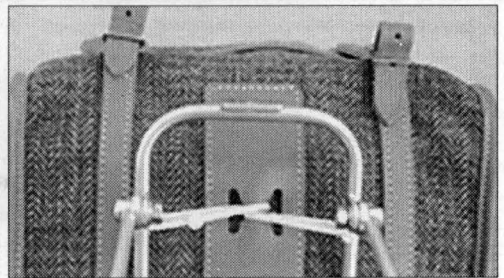
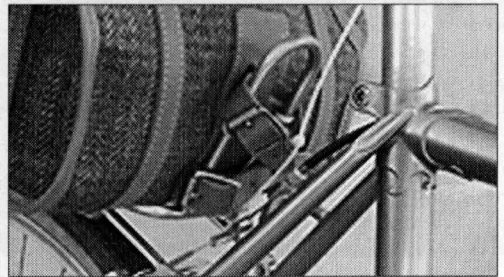

Note the loopless saddle, proof that you *can* rig a Smythe Country bag directly to a Mark's Rack. Put a cardboard stiffener in the bottom first to offer support for the bottom. Then strap both leather straps around the rack's tongue (middle photo), using a zip-tie to make sure the top strap stays there. On the bottom, run two zip-ties through the slots & around the rack sides independently. Snug both to lock the bag down to prevent side to side slidage—not the end of the world, but easily preventable.

## Nigel Smythe & Sons: A factional history...

As a lad growing up in the Cotswolds, Nigel's grandfather, Colin Smythe (1885-1968), never much cared for toys, but was enthralled by the boxes, chests, and bags in which they came. Though his parents thought it odd, soon enough those were the only toys he got. As Colin himself reported in a journal that the family still keeps, "It made for unusual Christmases, it did. My boxes never had nothing in them, they didn't, and I was happy with that! My younger brother gave me the boxes his presents came in, and so I always thought of my Christmases as doubles, as doubles."

What did he put into the boxes? Clothing, non-perishable snacks, and clean leaves. His father buckled under the stress of raising an odd-duck, so Colin and his mom and sister hit the road without a permanent home. But since boxes were too cumbersome to drag about, bags—which were squashable—became the substitutes.

Looking back, Colin reported in his journal that "I credit me mum for seeing that my fascination with boxes or bags and such dinna hurt nobody, and I was lucky to marry me a Scottish woman who, like mum, dinna think I was daft for it."

In 1905 Colin, having a fondness for thistles, moved to Scotland and married a local lass, Brigid. To support her, he started making bags for carriages, doctors, and travelling salesmen. The first bag he ever made still exists, but, tragically, the son of its senile owner won't part with it. It's a long story.

In 1907, Brigid gave birth to twins, Christopher and Emily. By the time they were old enough to be trusted with scissors, the children helped the family business grow and thrive—Emily cutting patterns, and Christopher setting rivets. By the time the twins turned 16, demand had grown to 500 bags per month, and the small family couldn't supply it. What made it worse was a growing market for bags made to look just like the Smythes. Father Colin accepted this as a natural consequence of having created a popular brand, but young Christopher was furious, and thrice was arrested for vandalizing the "spurious Smythes" as he called them, from local stores and on bikes whenever he saw them. Because these were his only conflicts with the law and because of his dad's good standing, he was let off lightly, spending only a week in the local detentiary. He was 30 years old.

It was a seminal period in Christopher's life, though. In the adjacent cell in the aforemen-

tioned detentiary was Hannah Mboglio, a native of the Belgian Congo (now Zaire). She had arrived in London just two days before, and, not knowing the local laws, was arrested when she failed to pay a cab fare. She thought the driver was offering her a free ride out of kindness. To make a long story short, a year later she and Christopher were married, and eight months later gave birth to twins—Nigel, Hanna (no second h). In the same year, Emily—who had married in '36—gave birth to daughter, Anna.

When Colin Smythe died of consumption (tuberculosis) in 1940, Hannah, who had become like a daughter to Colin, took his passing as hard as any of his blood family, and it was she who gave his eulogy—causing quite a stir in the then lily-white England. Historians generally agree that was the start of the civil rights movement in all of the United Kingdom—beating the U.S. by more than a full score.

At Hannah's urging, Christopher and Emily continued the family business, much to the delight of their mother. In 1942, at the peak of WWII and as the carriage bag business was dwindling, Emily suggested they introduce cycle bags to replace them. At the time, Carradice was the "cycle bag to beat," and another British bag, Karrimoor, also enjoyed a good reputation. Fortunately there was plenty of business for all, and each covered a different part of the U.K. Trade secrets were shared freely, and all brands flourished marvelously. It was Camelot-ish.

Young Nigel was passionate for cycling, and by the time he was 16, it was assumed he and Anna would take over the business. But Hanna moved to the United States to marry a sailor, so Nigel carried on alone. Nigel married Cora Fitzgibbon in 1944. They had two sons, Ian and Christopher, who carry on the business today, with Cora handling all the paperwork. Nigel, now 67, works only 4.2 days per week, secure in the knowledge that the future of his company is in good hands. He still oversees designs and aesthetic details, and is known to his materials suppliers as a "tough bruin" but fair & friendly.

Both George and Gale Smythe are keen cyclists, and in fact neither owns a motorcar. So often, in family businesses, passion diminishes with each passing of the torch; or the newer generation insists on change to establish its own reputation. This doesn't seem to be the case with Genevieve and Fritz. The future of the fine British cycling bag is in good hands!—GP



GBR

\$170

### Nigel Smythe & Sons Country Bag

This Country Bag is the best-designed and most stylish saddlebag we've seen. It's not radically different than others, but it has some details (mainly the buckles and the attachment points) that make it stand out and endear itself to you. It's about midway between the Little Joe and Adam in size, so it's not big enough to camp with, but it's a good size for a big day load including food, extra clothing, tools, camera, and a small cook kit.

The pockets and top flap close with buckles, and the buckles themselves have an old-fashioned leather quick-release—originated by Colin Smythe two years before his death, and now seen all over the U.K. Like all of Nigel & Sons bags, it's sewn as neatly as a lady's purse, and is as rugged as a thick boot.

You can lust strap it on the usual way, directly to the seat post, but as is the case with any saddlebag, you get a better attitude with a support of some kind. Set the support 6.5 to 9 inches below the saddle loops, and you'll be set for perfection.

Green plaid: 20-124 \$170 Blue herringbone: 20-140 \$170 Spray: 31-018 \$12

### Nigel Smythe & Sons Seat Pouch

This is an outright knock-off of the Baggins Banana bag, for those of us here, who Must Have Tweed.

As small seat bags go, you won't find anything better, classier, or easier to use. The Banana has been our top-selling bag since we introduced it five years ago, and this one here might cut into that some, but the point is, it sells so well because it works so well.

Most of the time it goes on the saddle, where you can route the straps over the seat rails, or through the saddlebag loops.

It also fits onto the stem, with the bottom strap then going around the head tube. It's not as slick a mount, but it works fine anyway.

Green plaid: 20-125 \$90 Blue herringbone: 20-141 \$90 Spray: 31-018 \$12



GBR

\$90



### Nigel Smythe & Sons Big Loafer

If you ride with a rear rack, especially the Nitto Top Rack (part no. 20-095), and you don't have this bag, well...time to stop the insanity. Nigel designed this bag specifically for that rack, although it works fine on many others.

At 15 inches long, it easily holds a family-sized loaf of Big White Puffy bread, but more importantly, it'll hold absolutely everything you need for a long hungry day in the saddle in changing weather. D-rings on the top allow you to keep a rain cape or extra wooly right at hand. It opens with a two-way zipper, and there's a leather mount for a red flasher light. With a Little Loafer in front and a Big Loafer in back, you're all set.

Green plaid: 20-126 \$95 Blue herringbone: 20-142 \$95 Spray: 31-018 \$12

### Nigel Smythe & Sons Little Loafer

You think puppy dogs are cute? And kittens? They pale in comparison to this bag.

It ought to mount onto any of several smallish racks, but in fact the only ones we know for sure it goes onto—because it was designed for them—are the Nitto Mark's rack and the Nitto Mini Front rack for cantilever-brake bikes. What do you



put in it? A loaf of pumpernickel and eight bagels, or four sandwiches, a wallet, and a rainshell. Your choice of two options. As with the Big Loafer, there are D-rings on top for keeping extra clothing super ready to be plucked. Two-way zipper and mount for a flasher light. Get this bag!

Green plaid: 20-127 \$87 Blue herringbone: 20-143 \$87 Spray: 31-018 \$12



GBR

\$95

### Nigel Smythe & Sons Bar Bag

This is like our Hobo bag, but we made it slightly narrower because one of our friends got a Hobo and said it was too wide for her handlebars. That made us feel bad, and this bag here is the result. Like all the bags from the Smythe clan, it has a tidy, upper-crust appearance, and every stitch is in lockstep. The main bag has extra sleeve pockets inside, for keeping expensive things away from gooey ones; a small sleeve pocket on the front is good for stubby pencils or BART tickets; and two bulging rear pockets are perfect for a small camera, snacks, and dog spray. No rack needed, and it fits great on almost any handlebar. Instructions included.

Green plaid: 20-128 \$95 Blue herringbone: 20-144 \$95

Spray: 31-018 \$12

### Nigel Smythe & Sons Bar Tube

This is our cheapest Smythe model, because it's just a tube with a zipper. You can put your lunch into one of these, along with a small extra jersey, wallet, keys, a camera, and a couple of other things about the size of a medium pine cone.

On cold days when you don't have your gloves, you can tuck your fingers behind this bag and get warmth from the wind-blockage and warmth from the wool.

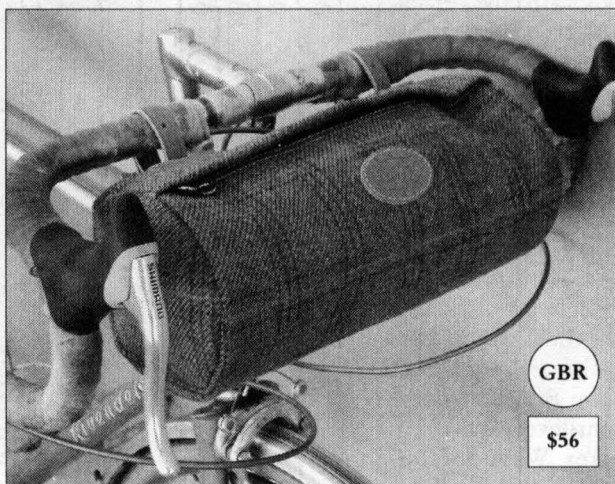

GBR

\$56

Put it on your bike and you'll never find a reason to remove it. Handy and handsome.

Green plaid: 20-129 \$56 Blue herringbone: 20-145 \$56

Spray: 31-018 \$12



## Bag capacities in cubic inches, liters, & peanuts in the shell

model	main bag	how many pockets ?	pockets	TOTAL CUBIC INCHES	Liters	Approx number of peanuts in the shell (based on 84 peanuts per 28.274 cubic inches)	weight (oz)	weight (lbs)	cu. Inch per lb.	liters per lb.	BAGGINS
	cu. In.		cu. In.								
<b>BAGGINS</b>											<b>BAGGINS</b>
hoss	1428	2	184	1612	26.4	4788	40	2.50	645	10.6	hoss
adam	990	2	113	1103	18.1	3276	38	2.40	459	7.5	adam
little joe	467	0	0	467	7.6	1386	29	1.80	259	4.2	little joe
banana	141	0	0	141	2.3	420	13	0.80	177	2.9	banana
hobo	424	2	102	526	8.6	1562	26	1.60	329	5.4	hobo
candy bar	175	0	0	175	2.9	521	8	0.50	351	5.7	candy bar
<b>NIGEL SMYTHE &amp; SONS</b>											<b>NIGEL SMYTHE &amp; SONS</b>
country	563	2	74	636	10.4	1890	29	1.80	353	5.8	country
seat pouch	141	0	0	141	2.3	420	14	0.90	157	2.6	seat pouch
little loafer	192	0	0	192	3.2	571	10	0.60	320	5.3	little loafer
big loafer	396	0	0	396	6.5	1176	16.5	1.03	384	6.3	big loafer
bar bag	424	2	57	481	7.9	1428	24	1.51	318	5.2	bar bag
bar tube	286	0	0	286	4.7	848	10	0.65	439	7.2	bar tube
Some bags have internal or sleeve pockets not counted here, because they don't increase capacity											
Capacities were measured by filling the bags with peanuts until they seemed comfortably full, just slightly bulging.											
Cubic inches per pound is a meaningless but mildly interesting figure. Don't overestimate its value.											

## Nitto Racks

Most bike racks are aluminum, some are steel. Most of the aluminum racks are solid, most of the steel ones are hollow. Hollow aluminum is too easily crimped, so nobody makes hollow aluminum racks. Solid steel is too heavy.

Nitto racks are made of tubular CrMo, short for "chrome-moly," a high-grade alloy used in nice bike frame tubing, also. The Cr stands for chromium, one of the main alloying elements, and the Mo is for molybdenum, one of the other alloying elements.

Nitto racks are exceptionally good-looking, because their nickel plating gives them a soft, satin look that at best makes any bike look better. It is scientifically impossible to dislike the look of soft silver.

The joints are fillet-brazed, which distributes the stress over a larger area than a tig-weld does, looks nice, and is another reason they're so costly. All the hardware is chrome-plated and glistens. Nitto is a conservative builder, and all Nitto racks are tested thoroughly by Nitto's own engineers. There isn't a cheap bit of hardware or a false move or slimy cover-up on them. In some cases they may weigh a little more than another company's rack, or a custom rack that seems to do about the same thing. But that is because Nitto tends to overbuild, and doesn't push the limits of weight to impress the weight-watchers. We believe they are the strongest racks in the world for their weight.

In some cases, there are few to no alternatives to these models; or the alternatives are there but nearly as expensive, so you might as well get the Nitto. In the case of the rear rack, though, there are several alternatives worth considering if you're looking for a good strong rack that costs a lot less. All in all, the rack offerings today are remarkably diverse in materials, looks, and price, but as a whole, they're good values, and it's a good time to be a rack-shopper. —Grant

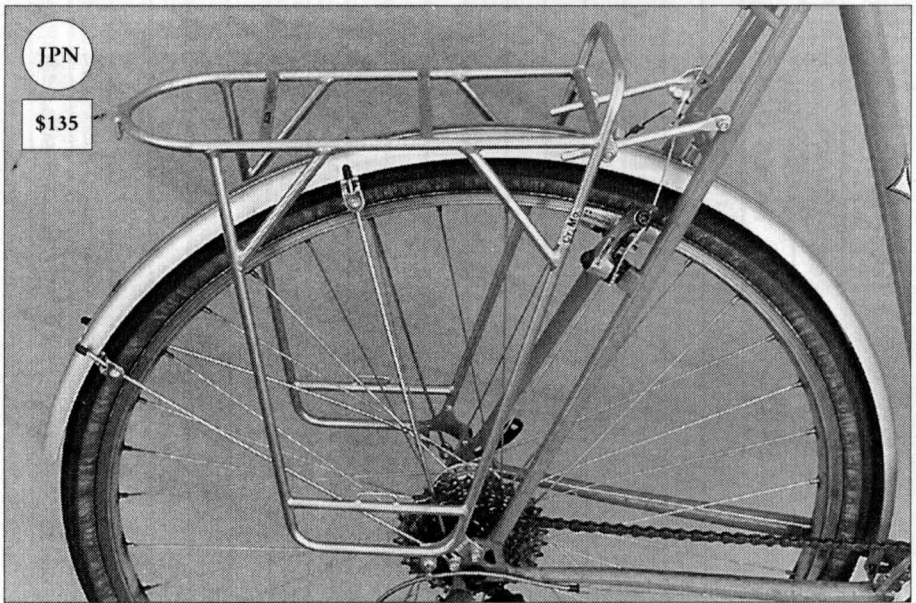

### Nitto Rear Rack

There are many nicely made rear racks that sell for between \$50 and \$75, but year after year we continue to sell this Nitto rack to kings and paupers and tourists rich and poor who want the best and most beautiful. It's tubular CrMo, fillet brazed, nickel-plated, and now, following a recent obsession to add triangles wherever, it has trussed-up corners. It wasn't necessary, but a great man once said "You can never have too many triangles," and who can argue with that? This is a gorgeous rack, super strong. With clamps for frames w/o eyelets.

For 700c: 20-021 \$135 For 26-inch and 650B: 20-022 \$135

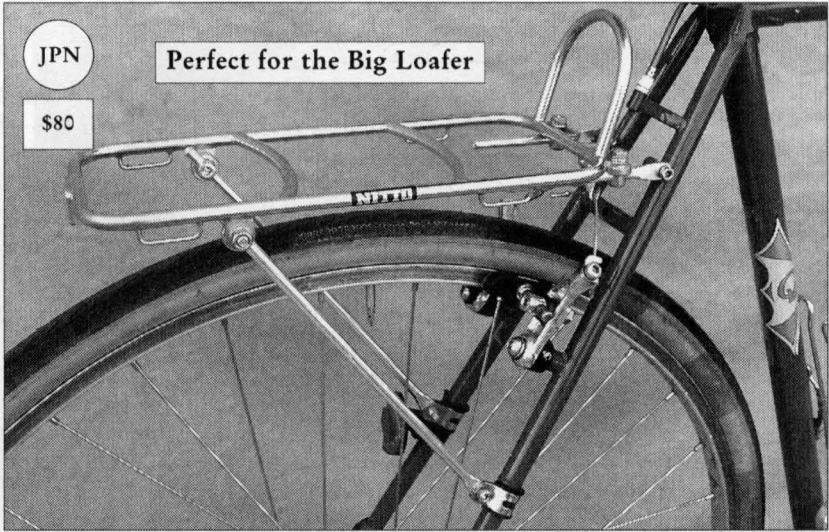

### Nitto Top Rack (R-14)

A clever and beautiful Nitto rack made just for us. It's perfect as a saddlebag support, the Nigel Smythe Big Loafer, a basket (with zip-ties), or any load you can fit on it. It's a cinch to mount, secure and lovely. It doubles the usefulness of any bike you put it on. It comes with four sets of clamps, for simple mounting to any bike with seat stays, whether it has rack braze-ons or not. As is the case with all Nitto racks, it is strong, gorgeous, and cleverly designed. As a saddle support for big bags or a rack for a trunk bag, it's unimprovable.

Nitto Top Rack (R-14): 20-095 \$80



### Top Rack with Sides (R-15)

This is a Top Rack with side supports that let you carry loads on the side, protected from the spokes. We had it made for the Berthoud Mini-Panniers, but even without them, you can just strap stuff-sacks on the side, for carrying extra clothing, food, or pretty much whatever you would put in the panniers if you had them. The Berthoud Mini-Panniers are just perfect for this rack, and in the future we'll have others...if Nigel agrees.

Saddlebag Support/Mini Rear: 20-094 \$90

## Mark's Rack

Our own Mark Abele came up with this design, and Nitto executed it perfectly. Basically, we wanted a rack that could be used

on the front of a bike with sidepull brakes, because sometimes sidepull users need to carry some extra stuff, too. Mark looked at some such racks from the past and present (including a Gilles Berthoud model) and came up with this unique and excessively (beyond extremely) clever design. Not only does it mount on the fork of a sidepull-equipped bike, but it also mounts on the rear; and as far as that goes, it works just as well if your bike has cantilevers. It's our smallest rack, and weighs between 11 and 13 ounces depending on how you rig it, but it's tubular CrMo, and can carry a larger load than its size suggests. There are lots of ways to use it—as a saddle-bag support in back, as a platform for a basket (zip-tie the basket on), or just strap a stuff-sack full of gear onto it. We use it all these ways, all the time.

Mark's Rack: 20-108 \$88, and frankly, a steal at that (for you, not us)

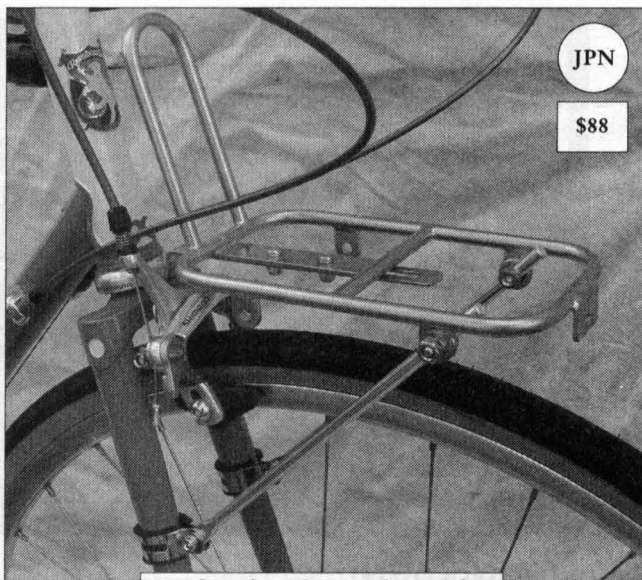

Perfect for the Little Loafer

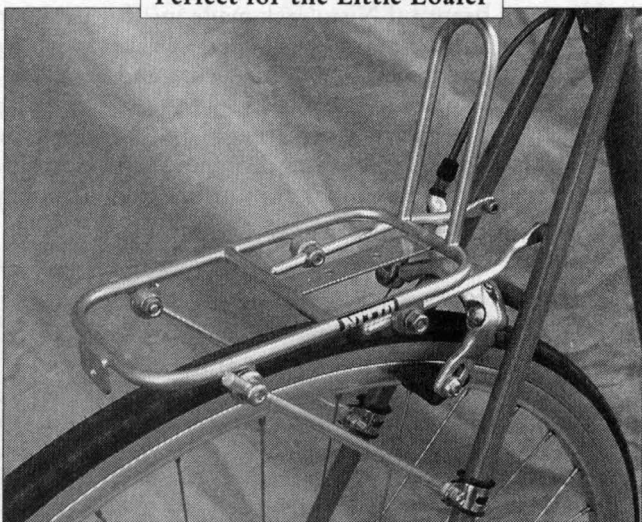

## A Useful Combo

The Little Loafer (p. 29) was designed to fit perfectly on Mark's Rack and the Nitto Mini-Front rack (both made by Nitto), so if you have one of these racks and have been riding around with nothing on it, it's time to stop the insanity and start toting stuff.

Four snaps and a loop of leather that slips over the rack's tongue secures it securely. It goes on and off in a few seconds. It looks too good to be true, and is a joy to use. For better or worse, strangers will ask about it.

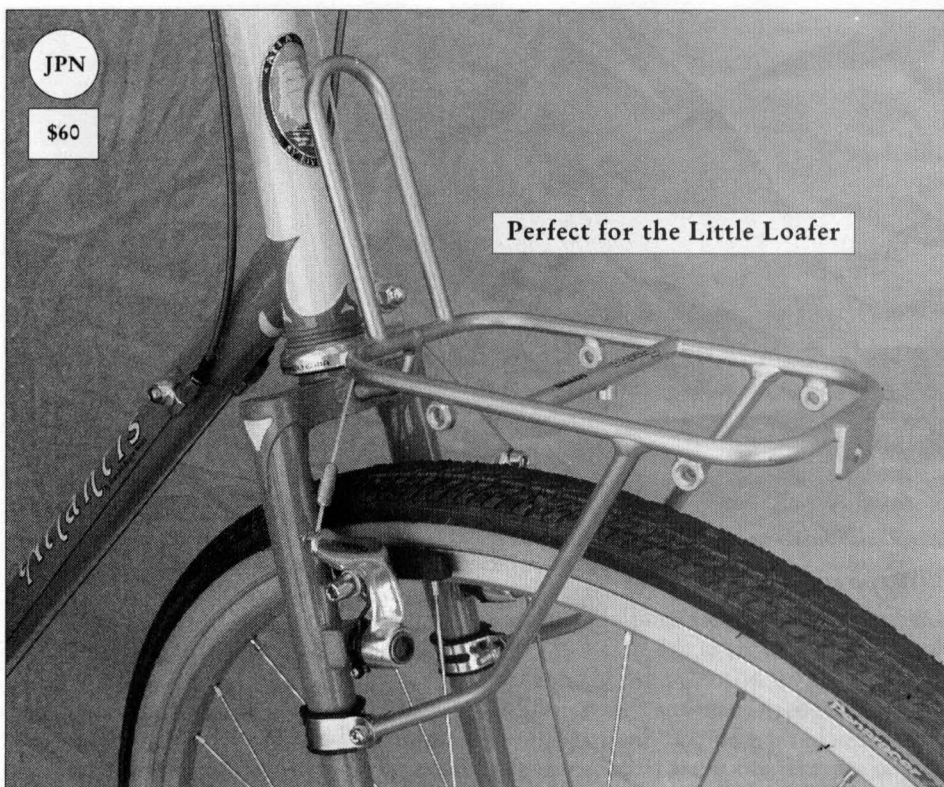

### Mini Front Rack for Cantilevers

When your bike has cantilevers or V-brakes and you just need a smallish rack up there for a bag or basket or stuff-sack, this is the best choice. Even Mark, of Mark's Rack fame, uses it on his bike with cantilever brakes. It has a threaded rod that mounts through the hole in the fork crown hole that isn't used because your bike has cantilevers, and then each lower leg of it clamps to the fork blade, using totally foolproof, reliable, cushioned, stainless steel, lightweight Nitto-made clamps and hardware. It's easy to mount, it mounts solidly, and any bike with a hole in the crown can be made more useful with this rack. No doubt there are some super fat forks there that it won't fit, but if the circumference of your fork at a point roughly 5 3/4-inches below the hole in the crown is within spitting distance of an inch, it'll be fine.

Mini Front Rack for cantilevers: 20-020 \$60

### Other Racks

Nitto makes full-sized frontracks, as well, and we may have them in stock as you read this, but they weren't in stock at the catalogue-printing time, so we left them out. They cost \$135 each, and you can see them on our website ([rivbike.com](http://rivbike.com)), and go to the online catalogue section).

There are other nice racks, besides Nitto. Gilles Berthoud makes some wonderful racks ([GillesBerthoud.com](http://GillesBerthoud.com)). Bruce Gordon has always made great racks, and is probably the person most responsible for inspiring other good racks. Bob Beckman, in Bend, makes a nice rack. IRD has a stainless rear rack that's really a nice design, sort of like a Jaand, but stainless, and it's less than \$50. Some things in bikedom have gotten worse over the years, but racks aren't one of 'em. There are more good racks now than ever before.



### Nitto Saddlebag Handle

Over the years several saddlebag users have made these things in their garage or workshop, but this is the first Big Time/Tom Jones/Madison Avenue version. It's made for us by Nitto, and it clamps onto your saddle's rails and provides a horizontal post for the straps that would ordinarily go into the saddlebag loops. Because what if your saddle is loopless? That's the thing. And even if it has loops, what if you want to take your saddlebag with you, so nobody can steal it while your bike is parked? That's another reason for this Handle. You just open the quick-release and grab the handle and take your bag with you.

It really is a clever device. Inspired by similar models made by Jobst Brandt, Peter Johnson, Darryl Skrabak, & Andrew "used to work here" Drummond.

It weighs 11oz/312g. In stock after June 20.

Saddlebag Handle: 20-109 \$55

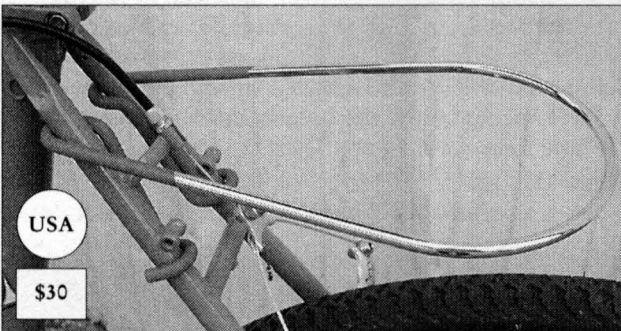

### Silver Hupe

It supports a saddlebag from underneath, which (1) keeps the bag from rubbing on a tire, if it would otherwise; (2) reduces any tendency for a big bag to sway; and (3) helps the bag sit flatter, for better access to the main load.

Back in the '70s, Park

Tool made a simple, sprung steel saddlebag support a lot like this one. A customer sent us one and said we should bring it back, and thanks to Google we found a willing & able & game tube bender in Wisconsin.

We copied the complicated part that attaches to the seat stays, and simplified the support part, lightening it in the process. It fits onto bikes with seatstays between 13mm and 17mm in diameter, and if there's only one seat stay (a "mono-stay") it won't fit. But if your frame is a normally configured steel frame, no problem. If it's not steel, measure the seat stays and go from there. It comes with instructions, without which you're in for a long frustrating evening that would ultimately be successful, but use the instructions.

Silver Hupe: 20-136 \$30

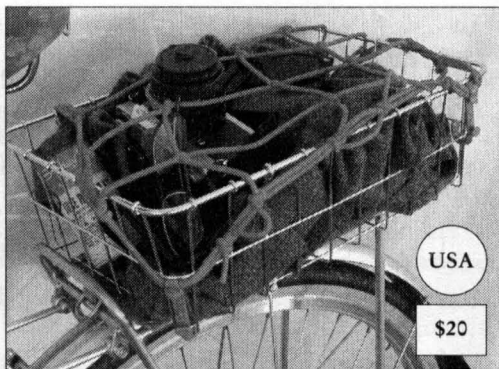

### Wald Baskets: The best in the world, and they're made in Kentucky

Wald has made bike parts in the United States since 1911, and in its current plant in Maysville, Kentucky since 1921. Its bicycle heyday started in the '40s and continued through the late '70s or so, a near 40-year period during which Wald supplied most of the hubs, cranks, handlebars, stems, seat posts, kickstands on tens of millions of Huffy, Murray, and Roadmaster bicycles. While such credentials elicit sneers from snobs, Wald has proven more stalwart than thousands of other American companies that have closed their doors or opened new doors overseas. So Wald has to be a sentimental favorite, at least. But listen: A Wald basket is hands-down my favorite, and I've seen lots of good baskets. The Walds, though, not only work right, but they look right. While others have overthought the mesh area and introduced improvements here and there, Wald keeps it simple and suffers not for it. The baskets are squares, not ovals, for more efficient packing. The mesh is airy, for less wind resistance when it's empty, and to minimize weight. The hardware is metal, the set-up is simple, and the welds are solid and so smooth, you can carry water balloons in them without fear of nicking. We offer a small selection of the most useful models, including one modified just for us. Get the net, too. You'll lose gear without it.

### Bar-mount basket with quick-release

The bracket mounts easily on drop or Albatross or straight handlebars. The basket itself lifts on and off in two seconds, and locks securely. Take the basket with you when you shop. It's 9.5" x 14.75" x 9" deep. Weight: 2.75lb. It carries a lot. In black powder-coat only.

Bar-mount basket: 20-097 \$20 Black net 20-100 \$8

### Wald Front or Rear Baskets

These versatile, lightweight baskets mount directly to your front or rear rack using zip-ties or velcro-wraps. The small basket carries plenty, and can be easily overfilled to carry gobs. The large one fits two big grocery bags side-by-side, making it the best choice for major food runs. What incredible bargains. Both are shiny silver.

Small: 9.95" x 15" x 4.75" , 17oz. Big: 13" x 18" x 6" , 26.5oz.

Wald Small Basket: 20-102 \$20 Wald Big Basket: 20-123 \$20 Black Net: 20-100 \$8

### Don't be a basket denigrator!

Baskets are great for odd-sized loads, daypacks, lots of things. They load quick and carry lots, and weigh little for what they tote. Everybody should have at least one basket on at least one bike.

## Picking a Handlebar

When you read about each bar, they *all* sound great, so it's easy to get paralyzed with indecision. Keep in mind two things: (1) Handlebars are inexpensive, so even if you pick a bar that isn't your bar-for-life, you'll still gain something from the experience, and won't go broke doing it; (2) We don't offer any lousy bars, so whatever bar you get will excel at something and be really good for everything else. However:

**Get the Noodle if:** You want a super comfy all-around road bar. This is by far our most popular drop bar, and receives more acclaim than any drop we've ever stocked.

**Get the Dream if:** The subtle details of the Noodle (the flare, flat ramp, and swept back top) make it too weird for your classical tastes.

**Get the Moustache Handlebar if:** You want the upright position & immediate access to the brakes (like a flat bar), but you want multiple hand positions & more stretch. This is a great bar. Everybody needs a bike with one. But get it high enough!

**Get the Albatross if:** You want a guilty amount of comfort, but don't want to be limited to an upright position. By grabbing the forward portion of the bar, you can tackle 18-percent hills in much the same body position as you'd have with a drop bar or a Moustache H'bar. Also, if you want that upright position and the option of another hand position for more aggressive or strenuous riding, the Albatross is the only bar in the world that'll provide it.

**Flat handlebars are not our favorites:** You can ride a bike with them, but they offer one non-ergonomic hand position. You can get add-ons to provide another grip option, but most of the time that's just throwing money at a problem caused by the wrong bar in the first place. We prefer curves.

## Different Grips on Drop-Style Handlebars

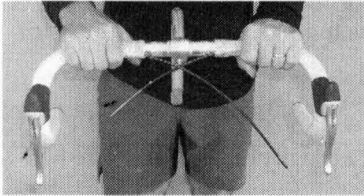

### Grab the tops

to allow you to sit more up-right. It's the normal position for long, seated climbs and low-effort flat-road riding. It doesn't matter where you put your hands. They'll roam, and wherever they end up is fine. There's no correct or incorrect way to put your hands here.

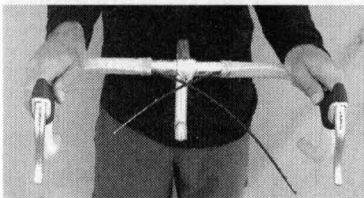

### Rest on the ramp

for slightly more aggressive riding, harder efforts, more speed. It leans you forward some, and makes it easy to move your hands to the hoods. This is probably where you'll spend most of your time, which is why the flat-ramped Noodle bar is such a good choice.

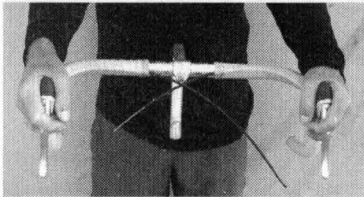

### Hold the hoods

for hard riding, like off-the-saddle climbs and seated sprints. The hoods are easy to hold onto while you're pulling hard on the bars to resist your hardest pedaling forces. Gives good access to the brakes. Usually, three fingers go behind the lever, one in front, but do what's comfortable.

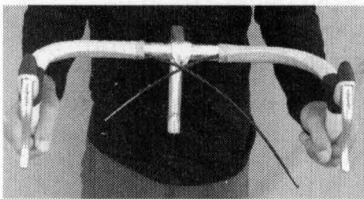

### Go down on the drops

for descents and sprints. Grabbing the drops lowers your profile and feels natural for hard efforts. On descents, it gives the best access to brakes. You can brake from the hoods, but you can reach the end of the brake lever from the drops, and that's a more powerful way to brake.



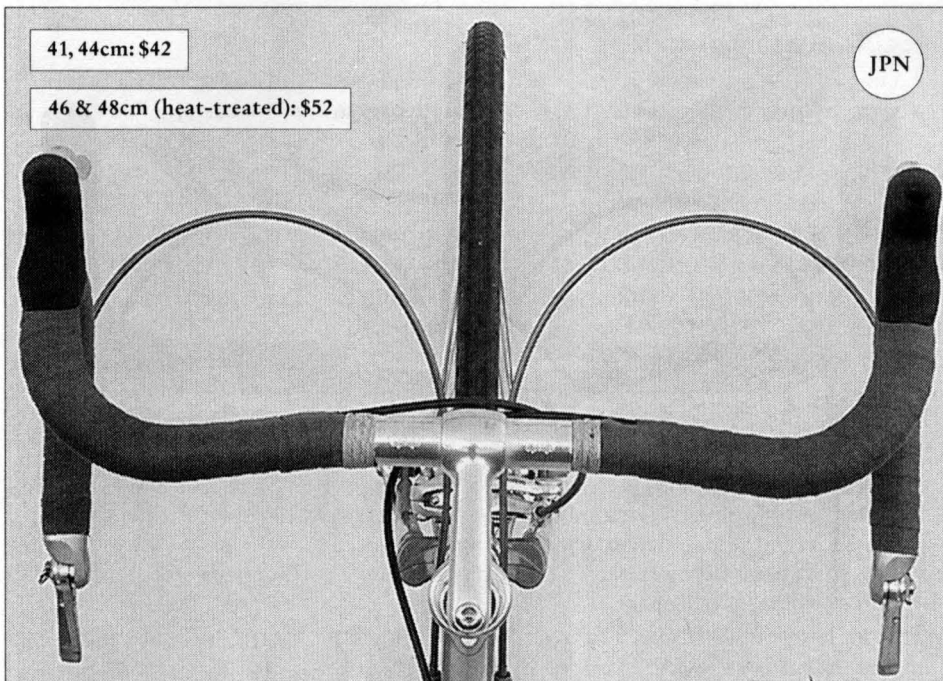

### Nitto Noodle Bar

*The drop bar riders who already like drops will go nuts over, and riders who don't like drops right now will actually be able to stand.*

In all likelihood the Noodle Bar will be the most comfortable drop bar you'll ever set grubby paws on. The top flat portion sweeps back toward you slightly, bringing the bar closer, and the drops (lower portion) flare out four degrees. But the main thing is the ramp—the portion of the bar immediately behind where the brake lever fits. The ramp matters because you put your hands there a lot, and if it's too steep, the support isn't there and your hands slide forward and down.

On most bars the ramp is about 24-to-32-degrees, but on the Noodle Bar, it's a much flatter 15 degrees. When you tilt the bar back properly, so that the ends point downward about 10-degrees, that already flattish 15-degree ramp becomes 5-degrees, so even if your hands are slathered in butter, they won't slide down off of that.

This has become our most popular drop bar, and some folks grumble that now they have to get one on all of their bikes. If you're debating between two sizes, consider that a wider bar offers more leverage, so you can more easily hold the bike as your legs (which are much stronger than your arms) push on the pedals and tilt the bike. We don't go along with the idea of getting handlebars as wide as your shoulders. Most people do better with wider bars.

41cm: 16-111 \$42    44cm: 16-112 \$42    46cm: 16-113 \$52    48cm: 16-128 \$52

stupendously comfortable flat ramp

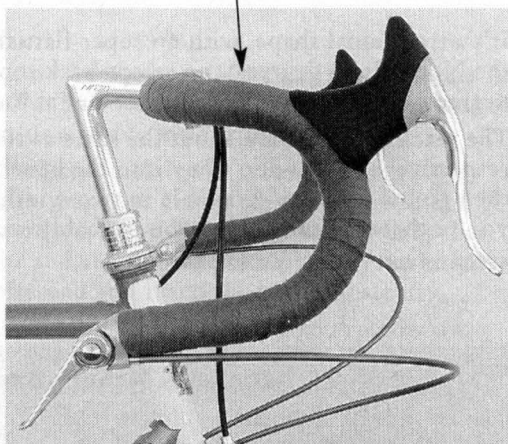

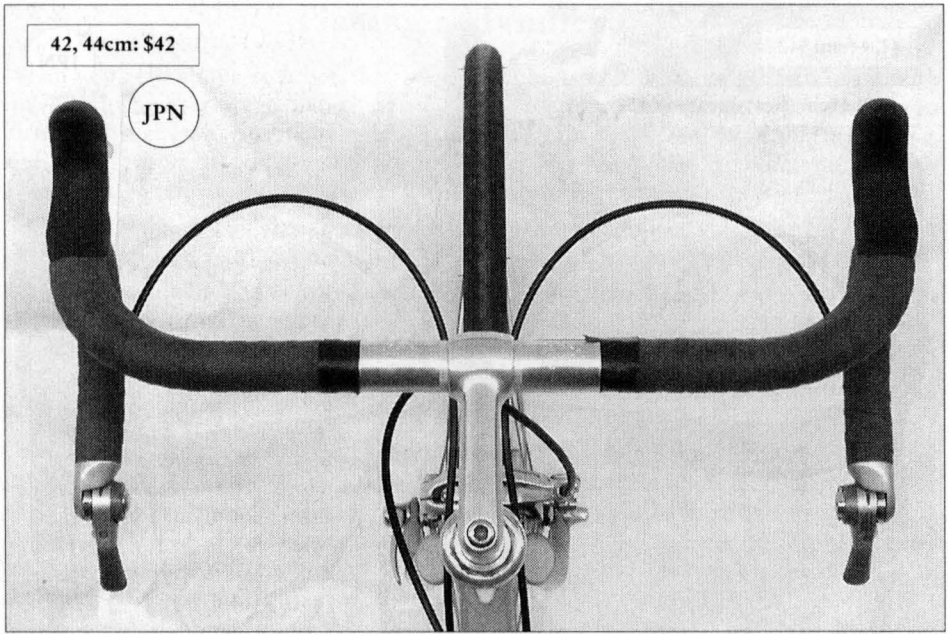

### Nitto Dream Bar

*Our traditionally shaped drop bar for those who for some reason or other aren't as head-over-heels in love with the Nitto Noodle Bar as we are.*

It's a traditional shape, with no super-flattish ramp (it's 23 degrees, compared to the Noodle's 15 degrees), no swept-back top section (the Noodle's comes back 15 degrees), and a mere 1 degree flare-out at the drops (Noodle: 4 degree).

The reach and drop are about the same as the Noodles—91mm and 140mm respectively. If you don't buy into the benefits of a flat ramp and a slight flare, then go for this one. Available in two widths only, our thoughts being that if you're that traditionalistic, you probably wouldn't go for a wide bar, either.

42cm: 16-081 44cm: 16-082 \$42

### Dream & Noodle Bar Specifications

	Dream	Noodle
<b>Material:</b>	44cm & narrower: Alum. (5056). Wider: Alum. 2014-T6 (heat treated)	
<b>Finish:</b>	Both satin. Not too shiny, not matte dull.	
<b>Width:</b>	42, 44cm	41, 44, 46, 48cm
<b>Reach:</b>	Both 91mm	
<b>Drop:</b>	Both 140mm	
<b>Weight:</b>	From 330g to 360g, depending on the width	
<b>Flare:</b>	1 degree	4 degrees
<b>Clamp Ø:</b>	Both 26mm	
<b>Bar OD:</b>	Both 23.8mm	
<b>Brake lever compatibility:</b>	Road levers. Not mountain levers.	
<b>Shifters compatibility:</b>	Both accept bar-end shifters.	

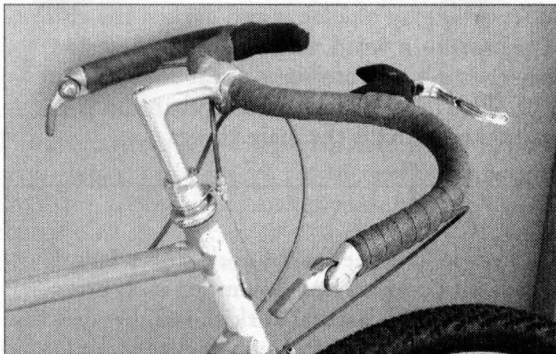
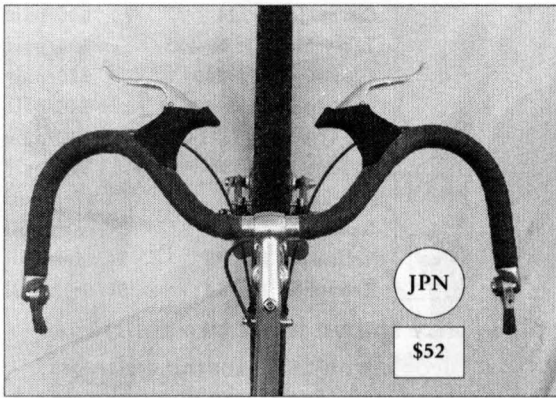

### Moustache H'bar Tips

1. Angle the ends slightly downward. 5 to 10 degrees is about right.
2. Get the part of the bars near the stem level with or above the saddle.
3. Set the brake levers level, and barely on the inside of the forward curve, so that the tips of the hoods (where the cables come out on non-aero levers) are 13 to 16cm apart. This gives easy access to the ends of the levers for good braking when you're in the curve, and offers a narrower, go-fast position when you're trying to go fast.
4. There is no better bar than a Moustache H'bar for steep climbs

### Nitto Moustache Handlebar

A wonderful handlebar, and a variation of a bar born 104 years ago. It offers the quick and easy braking position of a flat bar with the multiple hand positions of a drop bar—and is better than either for a whole lot of riding.

On a commute bike where speed, visibility, quick brake access, and multiple hand positions matter, there is no better bar. You can go fast on the road and get more aero than you can with a standard drop bar. The wider-than-a-drop-bar grip helps you to pull up steep climbs and stay in control on bumpy sprints. You can ride the Moustache Handlebar off-road and reach the brakes instantly.

If you find flat bars too confining, try a Moustache H'bar. If you're now on drops, but want a better position for commuting, or riding in town, or on trails, it may be just what you're after. It fits all road fittings and bar-end shifters. Made of heat-treated 2014 T6 aluminum, and suitable for off-road riding as well.

Use a short stem—7 to 9cm—and get the bar higher than the saddle. The Nitto DirtDrop stem is ideal, and the shorter Nitto Technomic Deluxes work well, too.

By the way: Nashbar sells what it calls a “moustache” bar, but it's not this one.

Moustache Handlebar, 26mm clamp: 16-028 \$52

### Moustache Handlebar Specifications

**Material:** Heat-treated Aluminum (2014 T6)

**Finish:** Satin **Width:** 51cm **Reach:** 95mm **Drop:** 48mm **Clamp Ø:** 26mm

**Bar ID:** 23.8mm

**Which brake levers fit?** Road levers.

**Fits bar-end shifters?** Yes.



JPN

\$10/pr

FRA

\$4 ea

Silver/J: 16-124	\$10/pair
Tealy Mint/J: 16-125	\$10/pair
Dk Blue/J: 16-141	\$10/pair
Lt. Blue/J: 16-142	\$10/pair
Dk Green/J: 16-143	\$10/pair
Celery/J: 16-156	\$10/pair
Black/F: 16-068	\$4/each roll
Red/F: 16-073	\$4/each roll
Yellow/F: 16-075	\$4/each roll
Brown/F: 16-114	\$4/each roll

### Japanese & French Cloth bar tape (price shown is for two rolls)

Cloth handlebar tape exists because some people won't ride anything else. Its feel is unduplicable by foam, plastics, and even cork, and if you don't like the color right out of the box, you can let it fade, or shellac it and darken the colors, or just let it age and develop some *beausage*—a word we made up to describe beauty through usage. You don't have to adopt it into your vocabulary, (but if you do, it's pronounced *byoo-sidge*). The French tape is thinner than the Japanese tape, but just get the color you like, that's the main thing.

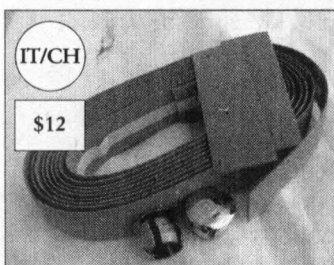

IT/CH

\$12

### Cork Tape

Some people love the feel of cork, and when it comes right down to it, who among us is not among them? The natural cork shows dirt quickly but looks like leather after you shellac it, and stays clean that way. Some people like the cush of cork but the feel of cotton. They wrap cotton over the cork. They're called "cork/cottoners."

Cork: 16-130 Dark Blue: 16-138 Medium Blue: 16-146

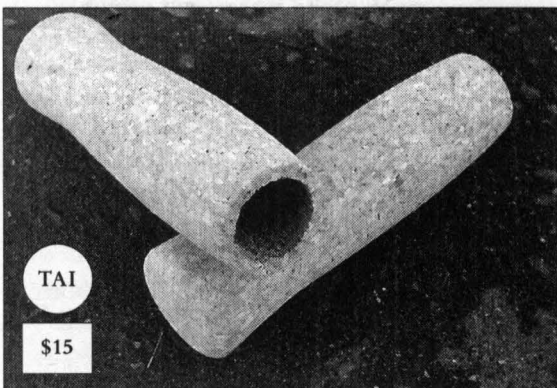

TAI

\$15

### Cork Grips

Neither cold in freezing temperatures, nor sticky in hot. For 22.2mm bars (Albatross, mountain bars) these are far & away our favorites, and once you try them you'll know why. Glue them on. Use 3M Spray Adhesive No. 77 or Gorilla Glue, both available at hardware stores. They shellac up nicely.

Cork Grips: 16-103 \$15

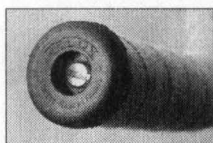

FRA

\$6/pr

### Velox Plugs

The oldest plug around, and the top choice for daytime riders and classicists. Black.

Velox Plugs: 16-077 \$6/pair



TAI

\$3/pr

### Reflector Plugs

Half the price, less than half the weight, and one billion times the reflectivity of the metal screwhead in the Velox plug. Just push them into your bars and go. The plug for light-weight fanatics who want, crave—nay, *demand* visibility.

Reflector Bar Plugs: 16-115 \$3/pair

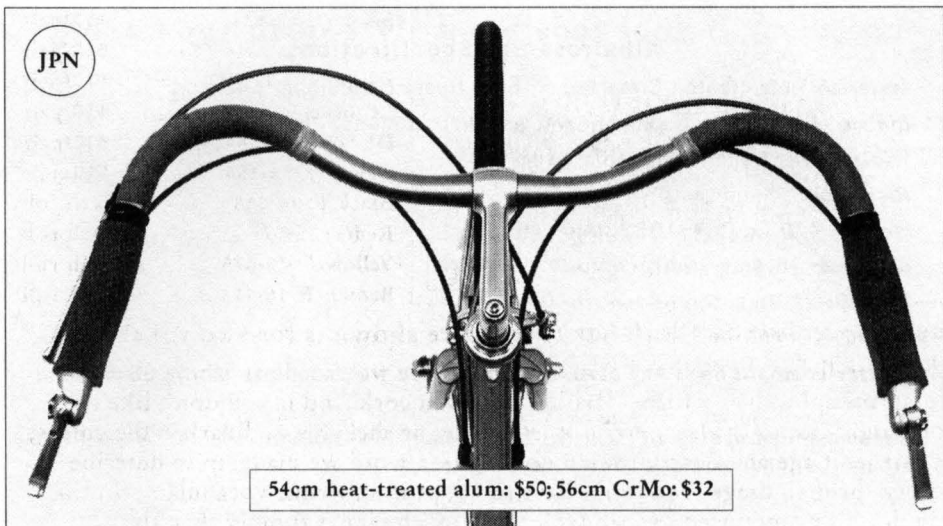

The Albatross's grip is longish, and when you keep the part ahead of the brake lever free, it provides you with another hand position for steep climbs or harder flat efforts. And so, it makes sense to tape it. There's no reason not to continue the tape all the way to the usual stopping place an inch or so from the stem, if that's what you want to do.

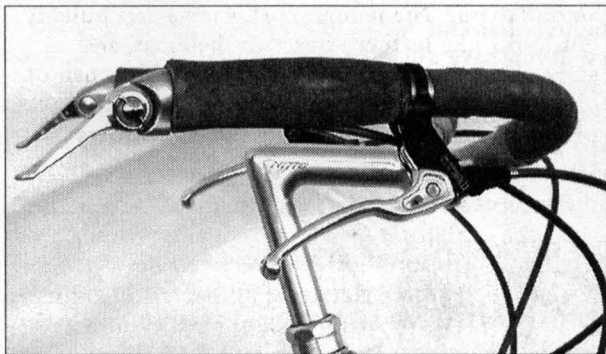

The Albatross has 65mm of rise, which helps sit you upright, and takes weight off your hands. Shown with cork grips, but any kind of grip will do, and you can just wrap them with thick bar tape, too.

### The Albatross Bar

This is a fantastic bar—great looking, extra comfortable, good for all kinds of riding on and off road, and is the only bar of its type (a lightweight, swept-back, old-fashioned type) that accepts bar-end shifters.

It's perfect for converting mountain bikes to comfortable all-around bikes. Lots of our Atlantis bikes go out with these bars. I/Grant have one like that, and I ride it everywhere, in all conditions.

If you ride a bike and have more than two or three of them, you ought to have this bar. It is the only bar in the world with this luscious look, this super quality, and that'll fit mountain bike brake levers and bar-end shifters. You could just as easily set it up with mountain bike shifters, but it was designed specifically to work with bar-end shifters, and doing it that way frees up more room in front of the brake lever, for a good off-the-saddle climbing grip. I/Grant like riding this bar now, and ride it a lot (average 60 miles per week year round on it); and I just know it's the bar I'll ride full-time when I'm rickety, too.

Try it on a good bike. It's worthy of the best bike you own.

Albatross, 56cm CrMo: 16-122 \$32 (good for most guys)

Albatross, 54cm Heat-Treated Aluminum: 16-127 \$50 (small guys, most women)

## Albatross Bar Specifications

**Material:** Heat-treated CrMo 56cm; heat-treated aluminum 54cm

**Finish:** Nickel plated, satin 56cm; polished aluminum 54cm

**Width:** CrMo 56cm; Aluminum 54cm

**Rise/Drop:** 65mm (both)

**Weight:** 470.6g CrMo; 362g Aluminum

**Clamp Ø:** 25.4mm (both)

**Bar OD:** 22.2mm (both)

**Bar ID:** 20mm

**Shifter compatibility:** Any style that'll go on a flat/mountain bar PLUS bar-end shifters.

**Recommended use:** Road, touring, commuting, fire trails (no stunts). A good all-around upright handlebar. You'll like it a lot.

## Tips for grips on upright bars (such as the Albatross)

### Poke a 7/8-inch hole in the end

Only if you're going to mount bar-end shifters. Poking the hole is easy if you have a raw chainstay around—you just insert the chainstay and whack it manly with a hammer, and the end punches out neat as a pin. Lacking a chainstay, get creative and crafty with drills, blades, or files. End up with a hole more or less like the one here.

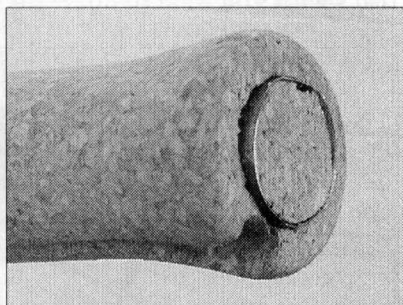

### File a groove for the housing

Using a round (rat-tail) file, make a groove about 2-inches long for the cable housing to nestle into. This isn't necessary, but we do it on the Albatross-bar bikes that we assemble here, and there are worse models to follow. It just helps the whole assemblage look and feel better. If you file through the grip, that's ok—the housing will just be flusher with the cork.



### File a recess for the twine

If you've gone this far, go the final step and use a file or dremel of a proper dimension to recess the cork grip slightly, making a place to lay down the twine. Then follow the twine-wrapping advice on page 46 or whatever page it ends up being on, and shellac over the whole thing. The cork turns beautifully golden, like a new Spaulding from the early 1960s.

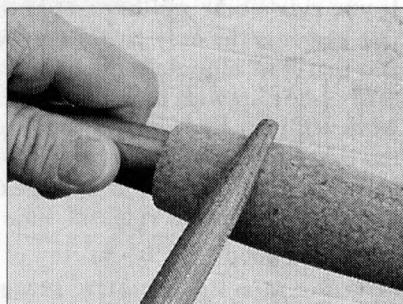

## Make your drop-style handlebar look & feel good

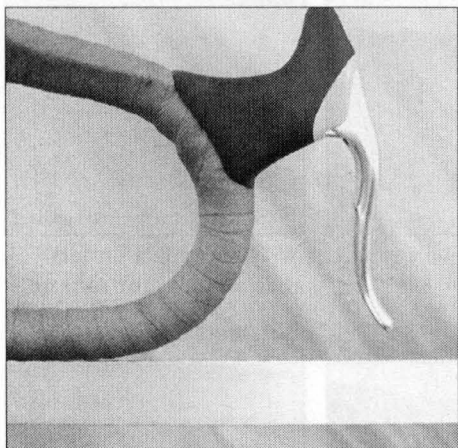

### Lever height

The “classic” position is with the bottom of the lever level with the bottom of the bar. That makes for fast and easy assembly at the factory, but unless you switch jobs, that shouldn’t be an issue for you.

You’ll probably prefer the lever about 15mm higher than that. Half an inch or so. It gives you a better perch when your hands are on the brake hoods, so there’s less tendency for your hands to slide down the slopy part of the curve onto the lever body. Look at the gap between the bottom of the lever and the white strip. It’s about 15mm.

### Pre-wrap the clamp

Cut a 2 1/2-inch piece of tape from each roll and cover the brake lever clamp. This one here is done minimally; another below it and another above it wouldn’t have hurt anything. Then, if you really want life to be easy, remove the body from the clamp. Scotch-tape the clamp in place while you pre-wrap it. Then wrap the bar without the lever body on it.

Wrap from the end of the bar, clockwise on the right, counter-clockwise on the left. You may find it works best to wrap the bottom and top halves separately (cutting the tape at the lever body. Purists howl at cut tape. Plug your ears!

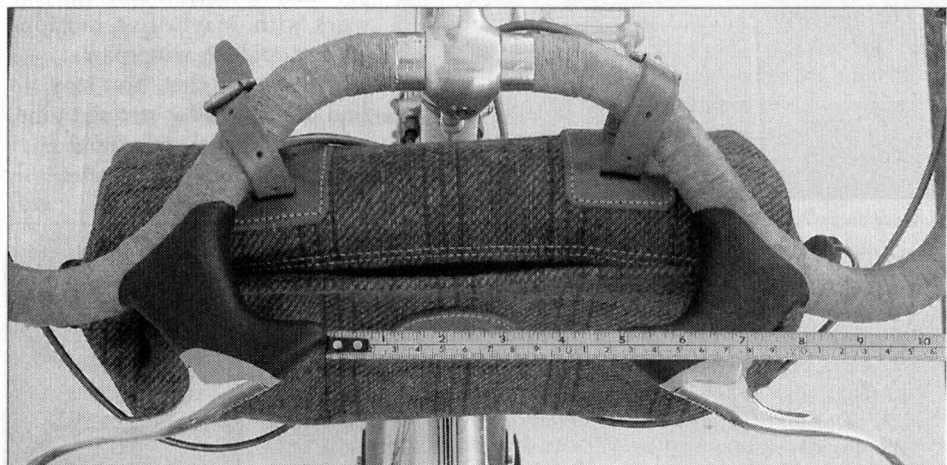
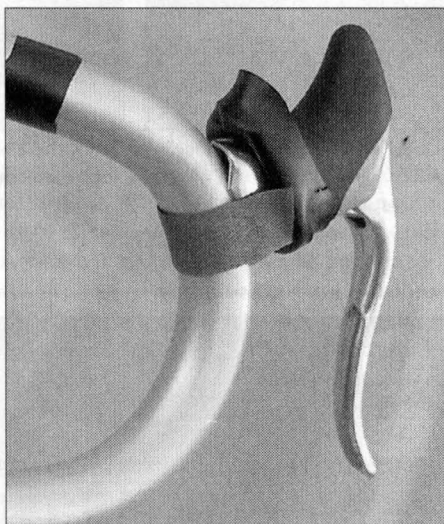

### Where to put the levers on a Moustache Handlebar

Most riders like them between 12cm and 15cm apart at the “tips,” as shown here. Put them horizontal to the ground, or tilted slightly down.

## How to finish off your wrapping with twine

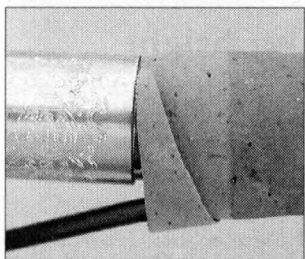

Angle cut to minimize the bulk.

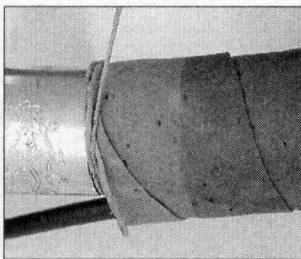

Face the bike, wrap away from you, and catch the twine with the first wrap, so it won't slip.

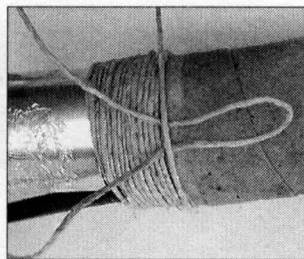

Wrap outward, a bit less than an inch...or to taste.

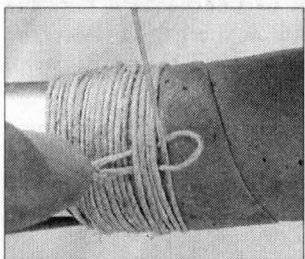

Use a separate 8-inch piece, make a loop, and wrap over it four times

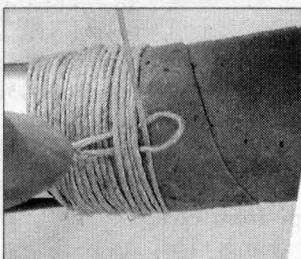

Stick the end through the loop like this...

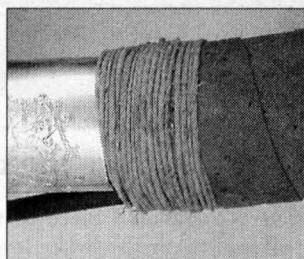

Pull it through, cut it off, glue or shellac it...then breathe hot air on your fingernails and rub them on your chest!



### 385 feet of Hemp Twine

What do you do when you're finished wrapping your handlebar? If you're high-class, you wrap down the end of the tape with about 3/4-inch of hemp twine, is what. Use about 6 feet per side, to make it easy to work with. Maybe five, but four isn't enough. A wingspan's worth—go by that. You may find other uses for strong twine, too. Five bucks—why not?

Hemp Twine: 16-086 \$5

### Shellac your bar tape & cork grips? Sure.

Shellac, which is colored bug excrement from India, has been used to protect and improve cotton handlebar tape for more than 59 years. It increases durability and adds rich color and texture. You can make your tape grippy or smooth, depending on how thick you apply it. Get a \$10 can of Bullseye shellac at a paint store, and a \$0.79 brush. Amber shellac turns blues to olives, white or grey to buckskin, yellow to goldenrodish, bright red to oxblood, and so on. The clear doesn't do much. One can will do about 75 handlebars or 300 pairs of cork grips.

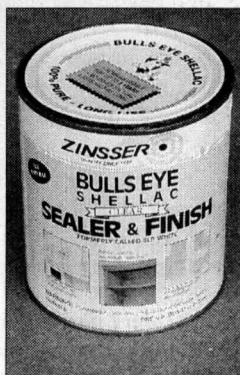



## The Secret To Comfort? Raise d'Bars!

*If You Don't Read Anything Else All Year, Read This Page*

*The most influential factor in your riding comfort is your riding position; and the most influential part of your position is your handlebar height. Ninety-nine percent of all road cyclers ride with their handlebars too low. When you raise your bars, good things happen.*

### Why High?

1. Relaxed, comfortable position. Higher handlebars sit you more upright and take weight off your hands and arms. Your triiceps don't tense up, and your hands don't go numb. With your arms relaxed, you can easily absorb road and trail shocks almost intuitively, by letting your body flex at the joints and act as a spring.

Higher bars also relieve strain from your neck and lower back. And if you can eliminate or reduce pain in your hands, arms, neck, and lower back, you're going to be comfortable, period.

2. Better descending. On a descent, you're already pointing your body downhill, and low bars just increase the steepness. Higher bars make any hill seem less steep, so you'll relax more, and enjoy it more. You'll be less likely to panic, and panic causes crashes. Higher handlebars make descents safer and more fun.

3. Better vision! Higher handlebars sit you more upright and give you a better view of traffic, the road, and the sights.

4. You'll ride more. Riding a bicycle is inherently fun, but body pains fix that. Higher handlebars can prevent most of the pains you suffer, so you'll ride more often and like it more.

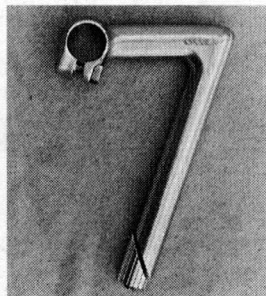
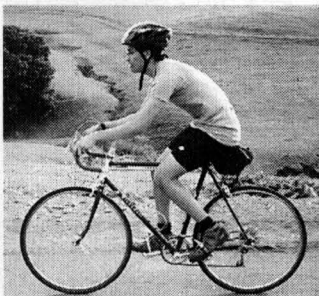

High handlebars give Debashis a relaxed position, good for comfort, vision, and descending. The stem here, a Nitto Technomic Deluxe, is one of many stems that can help you get a similar position. Starting with a bike that fits helps, too.

### How To Raise Your Bars

First, measure your saddle to the ground, then your handlebar tops to the ground, and see what the difference is.

If you're typical, your handlebars will be about five cm lower than the saddle. That's too much! Most riders are happy with the handlebars level with the top of the saddle, so start with that as a goal. Any raising of the bars will feel better, and there's no magic to making them level. You may prefer them a centimeter or two below the saddle, or six centimeters above it. Either way, brace yourself for a new stem.

If your bike has a threadless headset and a horizontal stem, replace it with one that juts up. Up-jutting stems that clamp onto a threadless steer tube are not common, but if your local shop doesn't have it, maybe they'll special order it for you.

### If your bike has a threaded headset, get:

1. A stem with a longer quill. If your stem's quill is 135mm and you want to raise the bars 35mm, you'll need a stem with a 170mm or longer quill.
2. A quill-style stem that rises, such as the Nitto DirtDrop.

Don't raise the stem above the minimum insert line. Also, make sure the new stem clamp diameter matches whatever handlebars you're going to use.

Nailing the perfect handlebar position takes experimentation. We're often asked "what stem length should I get"? First, just get the bars up there. Guess on the extension, and fine tune it if you need to. A spare stem or two is a small price to pay for a comfortable position.

Finally, don't go walking around convinced that only one position will work for you. —GP

## Things About Stems

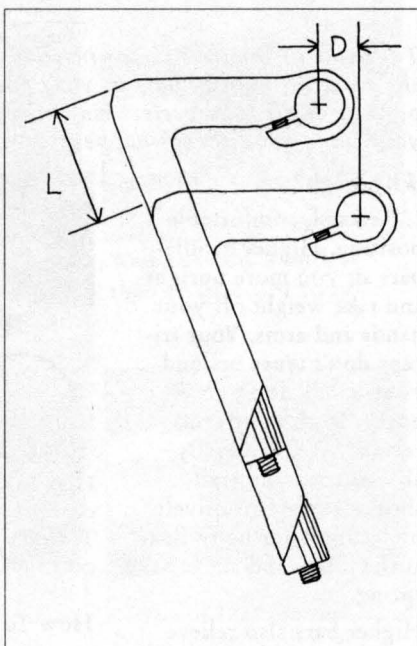
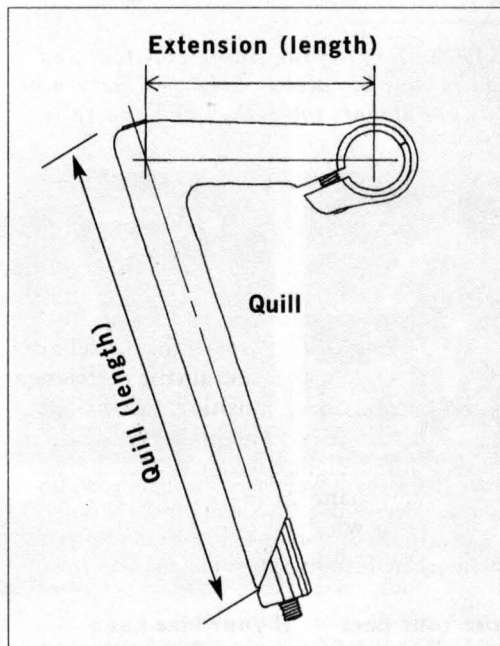

### How Our Stems Are Measured

From the centerline intersections of the quill and extension to the center of the handlebar clamp, as shown in the left diagram.

Don't mentally wrestle with stem length too much, or think you can ride only one length. Your body hinges and adapts and gets used to something that's close enough. Also, a 10cm extension with a higher handlebar feels like a 9cm with a lower bar—as shown in the right diagram. So, if your current bike has a low handlebar on a 9cm stem, and you replace the stem with one of the ones we offer that let you jack the bars up, get the new stem 1cm or so longer. Unless the low 9cm bar is way, way too long, in which case, go with another, taller 9cm stem.

### Nailing the right size stem...

...is not a matter of precise precision, threading a needle, smacking the bulls-eye from a faraway place, or getting lucky. Most riders who have several bikes do fine and are perfectly content just ballparking it. And with good reason! Think about it this way:

When your bike is standing still the handlebars are in a fixed-and-unchanging point in space. But as you ride the bike, all heck breaks loose. You climb a hill and the bar gets higher relative to the saddle. If it's a steep hill, it may be the equivalent of raising the bar four inches! And on a descent, the bar gets lower relative to the saddle. Then there's your body to think about. As you pedal over varied terrain you're constantly shifting forward and back on the saddle, sometimes you get up off it, stretching and bending your arms. Some position changes are subtle, but even the subtle ones would be considered huge if they were happening at the stem. With each change the relative distance to the handlebar changes, and in some cases, drastically. Your body adapts because it's rubbery and articulated and naturally adapts.

Don't stop trying to find the bulls-eye, but keep in mind that it's not one tiny point, but a 2-inch to 2.32-inch diameter circle, or thereabouts.

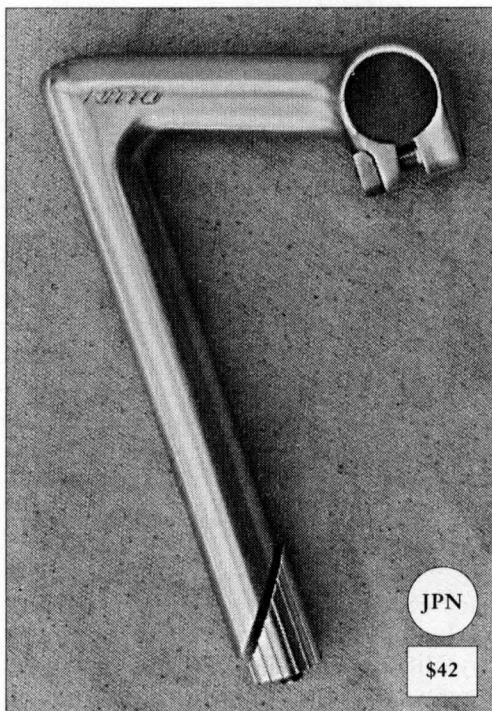

### Nitto Technomic Deluxe—classic looks & more comfort

Year after year this is our most popular chunk of metal. We have customers who put them on all of their bikes, and it is the stem we most often put onto custom-assembled Rivendell Atlantis and Rambouillet bicycles.

Its popularity is deserved. The quill is 190mm long, so you can raise your bars almost two inches higher than is possible with a standard 135mm-quill stem (like a Cinelli or 3ttt). It makes a dramatic difference in your body position and weight distribution. The higher handlebars shift weight to your rear and off your hands, and as that happens, your whole upper body relaxes, and you reduce the strain on your lower back and neck, too. It's a good way to ride.

All those benefits would justify this stem even if it were ugly, but it is beautiful, with proper proportions and finish worthy of any bike. It's a Nitto, so you know it's strong. The 26mm clamp fits almost all road handlebars (though not 26.4mm Cinelli bars, or the new & odd fatties). The 22.2mm quill fits a normal, 1-inch threaded steer tube except on some older French bikes. Get it and get comfy.

7cm: 16-044 8cm: 16-045 9cm: 16-046 10cm: 16-040 11cm: 16-041 12cm: 16-042  
\$42, all sizes.

### Who's Nitto?

Nitto is a small (48-person), old (since 1923) handlebar-stem-seat post-rack-and bottle cage maker in Tokyo, and everything Nitto makes is the best of whatever it is. The designs are always spare and beautiful. Nitto's company slogan is "Light weight, heavy duty, finely made," and it is accurate. There are lighter seat posts; but Nitto's are light enough, and stronger. Nitto will not build anything to its customer's specs if it doesn't pass Nitto's own internal standards. Nitto was at its biggest in the early to mid-eighties, during the mountain bike boom. Back then, the yen-to-dollar exchange rate was 250:1, and it was cheap to bring in Japanese goods. These days it's 109:1, which is why almost nothing you buy anymore is made in Japan.

Nitto can bend metal in ways that other makers just plain can't. Mr. Yoshikawa, who designs most of Nitto's products, has an eye for beauty that, in my experience, is unmatched. He takes our ideas and rough sketches, and turns them into stunningly lovely shapes—the Moustache Handlebar, the Noodle Bar—and he tests the heck out of them to make sure they're safe.

There aren't many companies like Nitto these days, and none other that I'm aware of making bike parts. It is a pleasure and an honor to offer them to you. Every loved bicycle deserves some kind of Nitto on it. —Grant

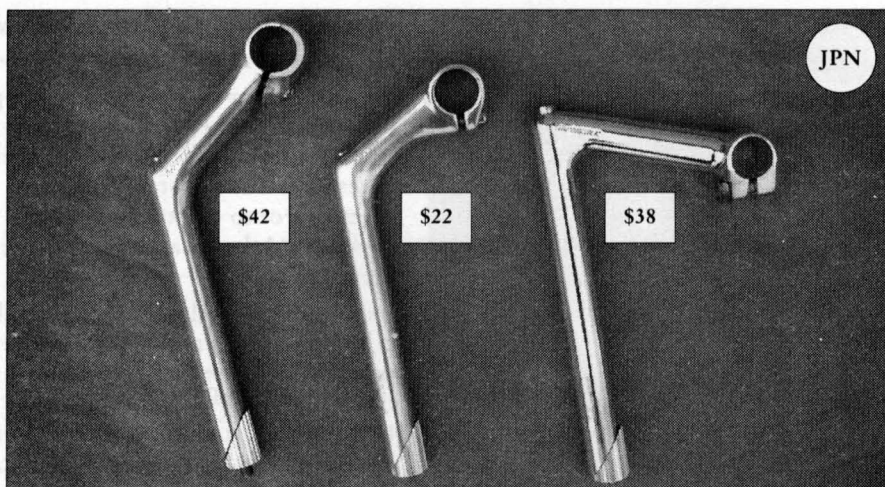

Left to right: DirtDrop 10cm (also available in 8cm); Periscopa; and Technomic

### Nitto DirtDrop—for jacking the bars way up there

Sometimes not even the Technomic can jack your bars up high enough, and then you need this DirtDrop. It brings the bars back and shoots them to the moon. Like all our stems, it is made in Tokyo by Nitto. The quill is 22.2mm, and fits normal, 1-inch threaded steerers. The clamp is 26mm, to fit most roadish bars made today. In 8cm or 10cm.

10cm: 16-100 8cm: 16-007 \$42

### Nitto Periscopa—basically a DirtDrop, but cheaper

The Periscopa has the highest height-to-low price ratio of any stem we have, and being a Nitto, you can trust it with your life. What a bargain.

It comes in one extension only, 80mm, with a 190mm quill. If you have an old mountain bike that nobody rides because it's not comfortable, put on this Periscopa and Albatross bars, and presto—the bike is now fun to ride.

The clamp is 25.4mm, so it fits all mountain bike bars, and the Albatross and Dove. The quill is 22.2mm, so it fits all normal bikes with 1-inch threaded headsets. If you are a guy, you will find it impossible to hold this stem in your hand without pretending it's a gun. Peacenik or not, it's automatic.

8cm Periscopa: 16-131 \$23

### Nitto Technomic—the classic backsaver, pretty inexpensive

The Technomic has been around for decades. It's a gravity cast stem, not forged like the other Nittos, but it's still plenty strong for road riding; although if you're up around 250 lbs and tend to be hard on gear, we suggest you don't raise it all the way up. Or just get the 10cm DirtDrop stem instead. The finish isn't as smooth as it is on the other stems, but it still scores a solid B+. It's made by Nitto, after all, and Nitto is incapable of ugliness.

The quill is a gangly 225mm. We offer this in 9cm only, but now in both 25.4cm for Albatross bar, and 26.0cm for our drop bars and Moustache H'bar. If your bike is way too small, this'll help.

Nitto Technomic 9cm

25.4cm: 16-047 26.0cm: 16-120 \$38

**Threadless stems for modern bikes. Lugged and forged aluminum**

Rumors are circulating about a trend to steerers that don't have threads on them, and which don't work with our beloved quill stems. Whether there's any truth to the rumor remains to be seen, but to secure our place on the cutting edge, we've developed a stem that will accommodate this new system. It is with pride and a pinch of ambivalence that we offer the two stems shown. They are the finest of their type. Both are made by Nitto in Tokyo. Nitto makes the best stems in the world, and these are the best threadless stems you can buy.

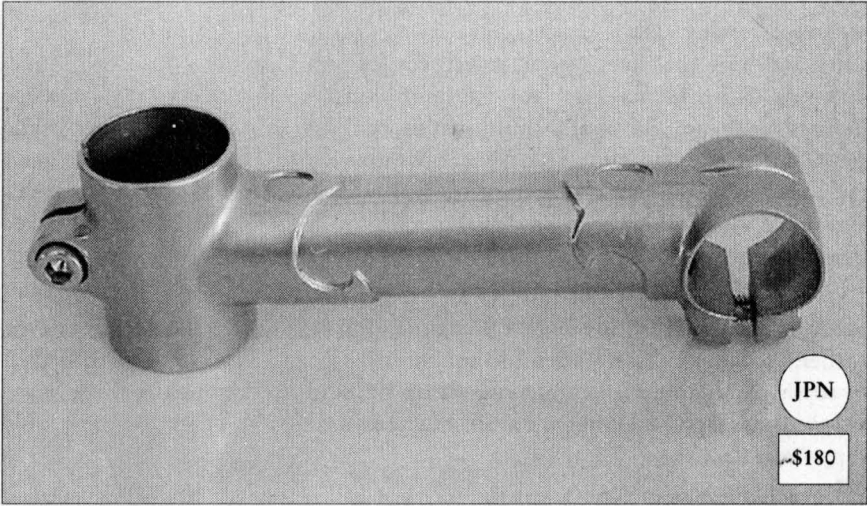

**Lugged clamp-on stem.** It has a 90-degree angle, so there's no point in flipping it. It lacks a front-opening plate, so asks for a longer commitment; a bit of self-knowledge from the get-go, you might say. But what a beautiful stem it is, and stronger than anything out there. All threadless stems should look this good.

8cm: 16-148 9cm: 16-149 10cm: 16-150 11cm: 16-151 12cm: 16-152 \$180

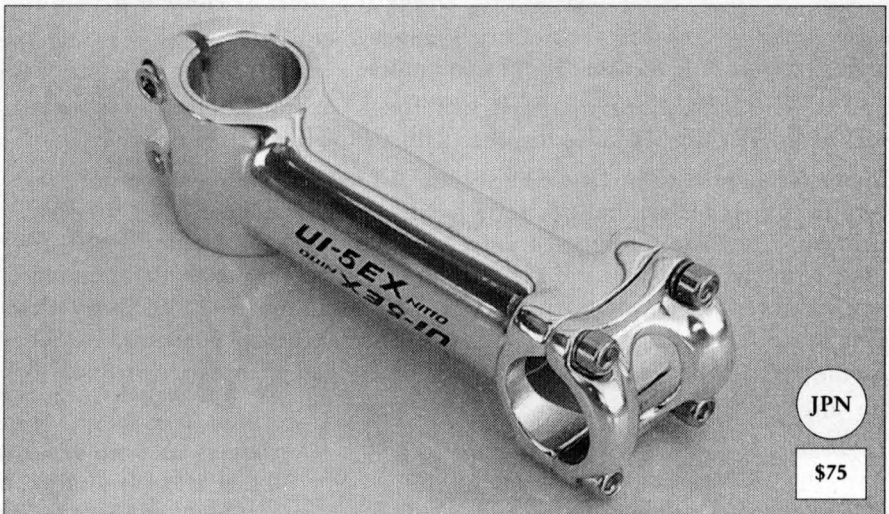

**Forged aluminum stem.** It has an 82-degree angle, so flipping it changes the bar height. It also has a removable front plate, so you can change handlebars with the snap of a finger. There are lots of threadless aluminum stems out there, but Nitto is the most particular maker, and so...we say this is the best of them.

9cm: 16-162 10cm: 16-163 11cm: 16-164 12cm: 16-165 \$75

## Easy Living with Leather Saddles

There are reasons experienced riders happily pay \$90 to \$150 for a relatively heavy saddle. Some do it just because leather saddles are far and away the best looking saddles out there, but most do it for comfort. Being leather doesn't guarantee comfort in a saddle any more than a lugged steel bicycle guarantees a comfortable position. There are lots of uncomfortable leather saddles. But it so happens that the best-designed, most universally appealing and comfortable saddle out there—the Brooks B.17— is leather.

Although leather saddle makers have always bragged about leather's breathability and how that keeps your crotch cooler—and how that in turn reduces all kinds of problems—we feel the main contribution that any saddle can make is its shape. The shape could just as easily be achieved with plastic and foam, but it usually isn't. The Avocet Women's Air 02 touring saddle has a good shape, and if you don't want to deal with a leather saddle, it's worth a try even if you aren't a woman. However, if you like the idea of a leather saddle and want to get the most out of it, here are some tips:

1. Use goop sparingly. On the top at least, and on the underside if you feel like it. Whether it's Proofide or Obenauf's, don't overdo it. You'll stretch the leather, and once it's stretched too much, it'll sag and lose its shape and ability to work. Leather saddles have tension bolts in the underside of the nose, and they can tighten things up a bit, but tensioning alone can't reshape a big floppy saddle.
2. Never ride it wet. One wet ride may not kill it, but on the other hand, it may. Wet leather stretches easily, and if you're a big guy pounding down the road on a saturated saddle, you're going to wreck it. Leather saddles are for year-round riding, but only if you protect them from getting soaked. Plastic bags or saddle bonnets are the way to go in the wet. Got a leather saddle? Then get a cover for it, period.
3. If it gets wet, let it dry slowly, at room temperature.
4. Don't store your bike outside for weeks at a time; or cover it if you do. You wouldn't sunbathe yourself for that long, and your saddle is just skin, and there's no cow to take care of it anymore.
5. If the side flaps start to flare out, drill five to six holes in the lower part of each flap, then lace the sides together with a shoe lace or zip ties.

That's all there is to it. Don't be scared. All natural products require more care than does plastic, but it's not a hassle. Four catalogues ago I suggested that you could expect a good leather saddle to last 15,000 miles. I was deluged with claims of two and three times that. I still think that's optimistic, but whatever it is, leather saddles are a bargain, and we're all lucky that they're still being made. Brooks, by the way, was recently purchased by Selle Royal, one of Italy's biggest saddle makers. No bad changes are planned!

## By All Means, Please Seek These Three Things in Seats

### One: Enough Width

The rear part of the saddle should be wide enough to support your sit bones. This is a Brooks B.17, and it happens to be 17cm wide, which, based on where the sit bones imprint the leather, seems to be about minimum width for a good saddle. Yet the typical racing saddle is about 15cm wide.

Racers are light, leaned over, and pedal hard all the time, and that combination reduces pressure on the soft spots. That's not to say they don't get numb or sore; but for a heavier rider wanting a more practical, upright, comfortable riding position, a narrow racing saddle is not a good choice.

Narrow: 15cm to 16cm wide.

Medium: About 17cm wide.

Wide: Wider than 18cm.

18cm: In between Medium and Wide.

16.5cm: Nobody makes one.

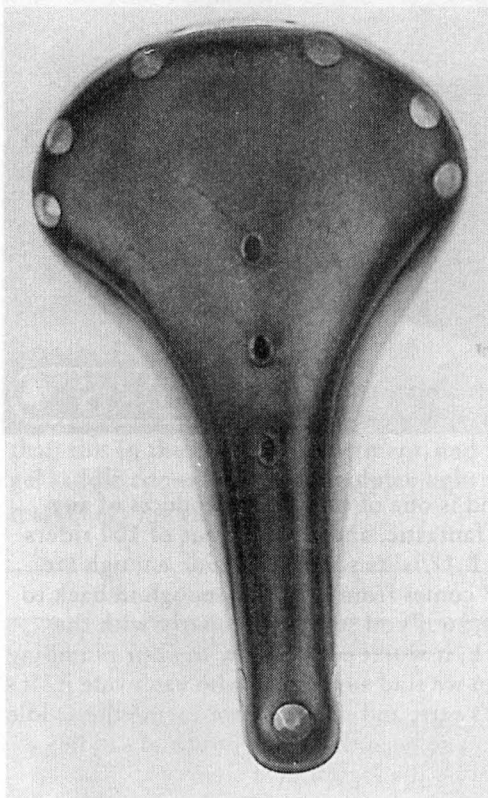

### Two: A Flattish Rear

That's so your sit bones don't try to slide off it. If they do that, there's upward pressure on your genitals, and forget it. If you look closely at this saddle, you'll see indentations made by sit bones.

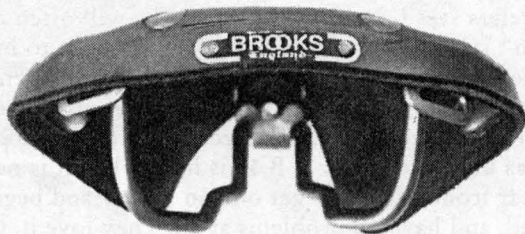

### Three: A Higher Rear than Middle

See how the rear part of the saddle, where your sit bones rest, is a bit higher than the middle, where your genitals are? It makes a big difference. It reduces pressure on your genitals. Make sure the rear is higher than the middle.

this part is higher

than this part



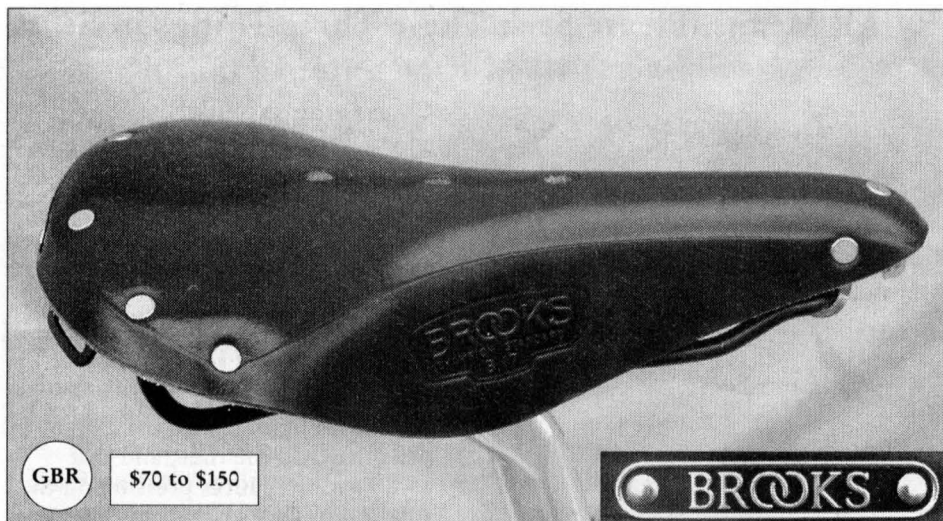

### Brooks B.17

This is one of Brooks' oldest models, and is one of those rare products of any kind that is unimprovable. The B.17 is fantastic, and truly 97 out of 100 riders will find it just right. The magic of the B.17 is its shape. It's wide enough (at 17cm wide—that's likely where the B.17 comes from) and flat enough in back to support your sit bones. It's shaped right, so if you set it up properly with the rear portion slightly higher than the neck, it won't cut off flow to your plumbing or crush your folds. Every now and then we find somebody who can't ride it. It's too wide. Mark, here, is like that. But it's rare, and if you're not loving the saddle you're on right now, and especially if you've been through a bunch of saddles and never warmed up to any of them, this is the logical next step.

There is a rumor, perpetuated by those who have never ridden a B.17, that leather saddles are uncomfortable and take forever to break in. When the new crop of cyclers sees one on a bike, he or she will often remark, "Hey, retro, cool, but isn't it uncomfortable?" It's like they want to high-five you for enduring pain for the sake of tradition. It isn't retro, it is leather, and leather has proven itself a good seating material for hundreds of years, in all kinds of applications. It's incredibly comfortable. It would be foolish to pay more for a heavier saddle that was uncomfortable. A B.17 is hard when it is new, but the shape is right, and we hear from folks who get one on Friday and begin long tours with it on the weekend, and have no problems at all. They love it. One woman wrote that it began to bother her 350 miles into an ultramarathon ride. Most people can't sit in a chair for that long.

Brooks saddles are hard to come by. In the old days, we could get the B.17 in assorted colors and rail materials, and life was good. Three years ago, Selle Royale of Italy bought Brooks, and to its credit, made some nice functional and cosmetic changes in the saddles, including the B.17. For instance, the saddlebag loops are smoother, not as likely to cut into a saddlebag strap. The badge in back is bumpy again (has relief), like it did in the '70s and earlier. The old black standard B.17 was made with thinner leather, but the new ones seem right and thick, like the deluxe models Brooks made for us. So even though the delivery has not been good, it seems to be getting better, and we expect good stock.

B.17 Standard Black black painted steel rails: 11-055 \$70

B.17 Standard Honey with black painted steel rails: 11-056 \$70

B.17 Champion Honey Brown, copper-plated steel rails: 11-006 \$95

B.17 Champion Honey Brown, titanium through and through rails: 11-046 \$150

B.17 Womens Honey Brown, black steel rails: 11-058 \$70

FLASH: We just got in the ultra-fancy women's B.18. See it on our site.



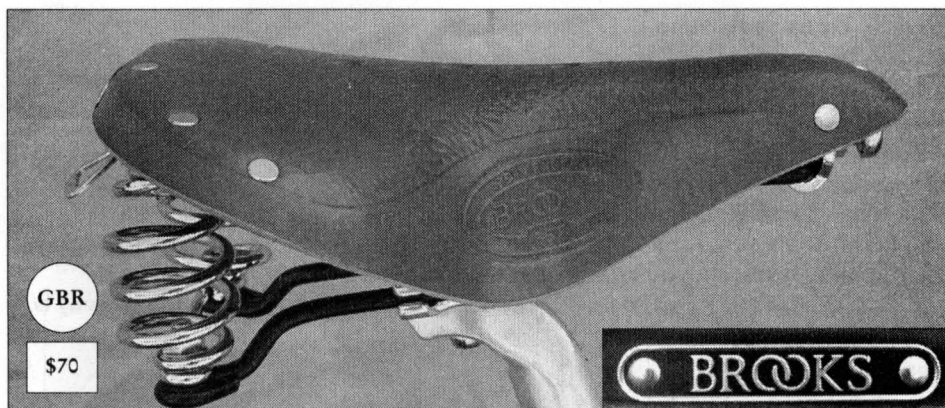

### Brooks B.67

If you sit upright, sit on a wider saddle that supports you more. This saddle is the answer, and it has springs, too, for extra comfort. You won't do any better than this in the comfort department, and in the looks department, no plastic-n-gel saddle comes within googolplex light years of it. Honey brown.

B.67 honey brown: 11-043 \$70



### Brooks Finesse

This is Brooks's seat for wealthy women who want a lightweight saddle for all-around riding and a riding position that tends a hair toward upright; at least more so than horizontal. It's 3cm wider than a B.17, because many women have wider ischial tuberosities; and it has a snubby nose, so a dress can hang off it easily. We've sold this saddle on and off for many years—on when we can be assured of a steady supply, and off when they're just too hard to get. We're pleased to report that at least for the next year or so, the supply should be fine. All Brooks saddles now have bag loops. This one did even before that was true, though, so we've liked it all along.

Finesse, honey brown: 11-050 \$150

### Saddle Bonnet for the B.17

For rainy or hot rides to keep the rain or sweat off, and to keep a new saddle from staining your pants. It is stitched, so if you're paranoid, put a plastic bag under it. It has secret sewn-in pockets into which you may slide similarly shaped pieces cut out of closed-cell foam, and a tiny loop for tethering it to your seat post in case you're scared it'll come off. That's unlikely to happen, but not impossible, and the loop (not shown) is our overreaction to something that's happened twice.

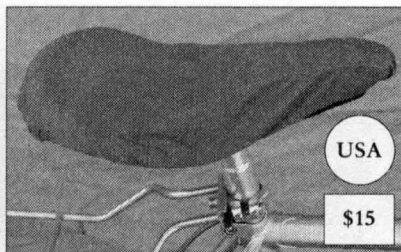

Bonnet: 31-345 \$15

### Obenauf's

This is the stuff we prefer over all others for saddles, shoes, belts, baseball mitts, and the leather on saddlebags. Made with beeswax and propolis, for firefighters. A blob the size of a pencil eraser will coat the top of one whole Brooks B.17.

Obenauf's dinky tub: 31-243 \$3

Obenauf's quarter-pounder: 31-344 \$8

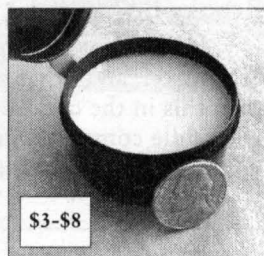

### Brooks Spanner

You may never need this, but if you ever want to tension the leather, this tool will make the difference between a satisfying experience and wanting to blow your brains out. No normal tool works worth beans, and this is only \$6. Cute, compact, chromed, and probably not essential, but if \$6 won't kill you and your saddle adjusts with a hex nut (some use allens), then you ought to get this.

Brooks Spanner: 19-013 \$6

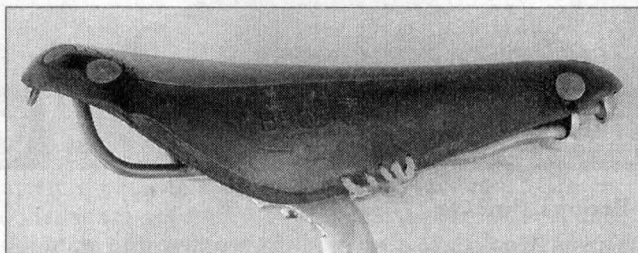
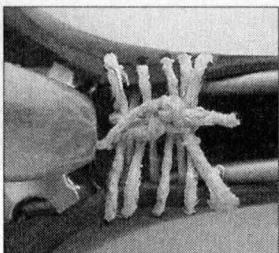

### Resurrect a saggy saddle

Sometimes when you've been bad, your saddle gets saggy. It happens over time and is usually caused by riding it wet, but it could just be that you got a rare lemon. Either way, it's easy to fix, as most things *are*, with a length of twine.

Drill about 5 to 6 holes on each side, then lace the two sides of the saddle like lacing a shoe. Use beeswaxed shoelaces or strong twine. In the past, many saddles came with holes pre-drilled, and one or two still do. We prefer to drill our own, especially since none of the saddles we stock have holes. A saddle saved this way is highly resistant to re-sagging.

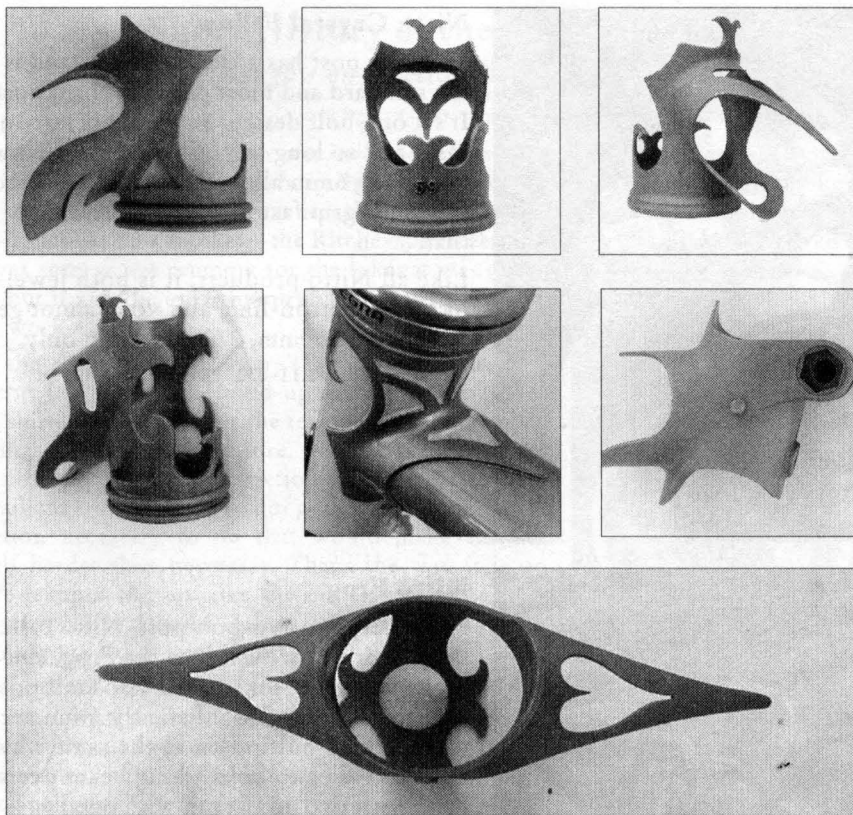

## Lugs ... and Lugs for Sale

These days when people see a lugged bike, they assume it's low-tech or old-fashioned, or a modern rendition of an old classic. They wouldn't say that about a fine pair of leather shoes, or a nice piece of wooden furniture, or a fine violin. They might say that about a bamboo fly rod, but they'd be wrong there, too.

Lugs are so interesting and beautiful and diverse. There are so many kinds, that if you don't like one, you'll like another. I used to think some lugs were pretty and some were ugly, but over the years I've softened some. I like some lug details and styles more than others, but I can't look at any lug without imagining somebody drawing it out and being proud of it when it was finally made, and I can't imagine making bikes without them. Besides, when lugs are so rare, why step on any?

We have lots of lugs that we don't use anymore, and spares of ones we do. Some we've discontinued because the frame styles changed, or they were good lugs but a pain to work with, or some other reason that has no bearing on anything. If you want one of these lugs just to have as a neat piece of investment cast steel, or an ornament for your desktop or Christmas tree (don't underestimate its effectiveness there, either), we'll sell you one. You can't get a whole set because we don't want anybody else building a frame with our lugs; and you don't get to pick the lug. On the other hand, we'll sell them well below our cost, just to get them in your hands... and to clear out perfectly good lugs we have no use for.

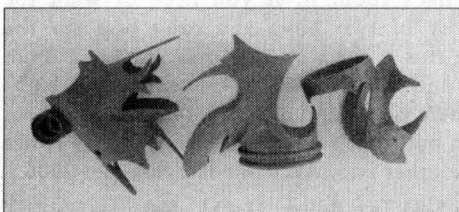

The lug you get may not be one of these, but it'll be one we've used and still like, and on the other hand, maybe it will be one of these. It'll be a good lug, anyway.

Random Lug: 31-444 \$3

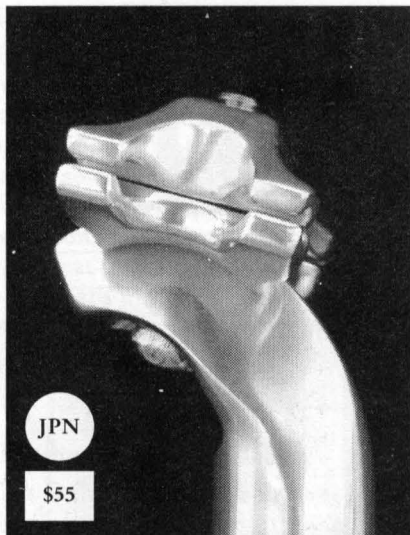

JPN

\$55

### Nitto Crystal Fellow

This seat post has a curious name, and is the standard and most popular Nitto post. It's a one-bolt design, so set-up is fast and easy; and so long as you grease the bolt and use a long 6mm allen and put some muscle to it, it'll grip fast forever and that'll be that.

Like all Nitto products, it is both jewel-like and Samson-like, and you cannot get any better. 250mm, 270g, 27.2mm only.

Crystal Fellow: 11-031 \$55

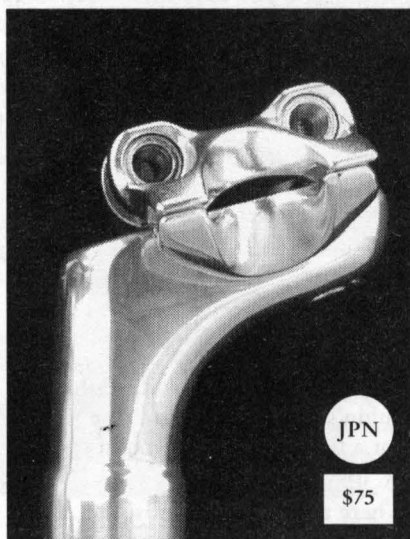

JPN

\$75

### Nitto Frog

Nitto's elusive two-bolt post. Nitto calls it the Jaguar but we sell it as the Frog, since it looks more frog-like to us. Two-bolt posts are rare, but are also inherently more secure than are one-bolt posts, in the same way that it's easier to hold a long beam overhead with two arms than with one.

It's "elusive" because we don't get many in. In fact, we're probably out of stock, so get the other! 210mm, 270g, 27.2mm only.

Frog: 11-016 \$75

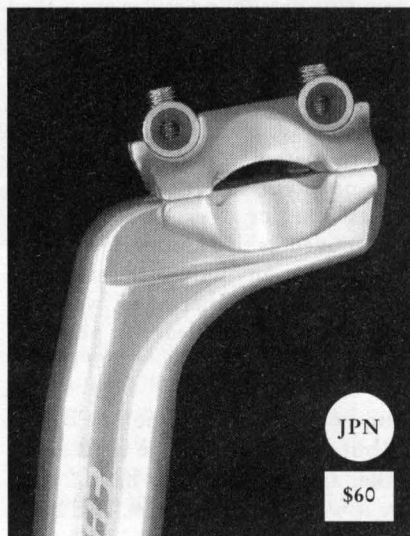

JPN

\$60

### Nitto S83

We are vehemently opposed to stocking too many things in any one category, but we want to support Nitto's new efforts when they make sense for us, which a nice seat post does. Nitto doesn't come out with new things often, so even a seat post whose function is already overlapped by existing models makes us want to stand and applaud respectfully.

This "S-83" post is a two-bolt post as the Frog is, but costs less because the clamp is different, and that's about it. If you need or want the security of two bolts and can't pop for the Frog, this is the way to go. 27.2mm x 250mm only, and silver. It has "S-83" on the side, barely. There is no good reason for us to stock three posts, but there's no good reason to drop either of the other two. Available late Summer 2006.

Nitto S-83 Two Bolter: 11-053 \$60

## A Short History of the Power Ratchet and Thoughts on Friction Shifting in General

The best shifting mechanism ever invented is SunTour's Power Ratchet. SunTour introduced it in the late '70s in a cheap thumb shifter called the Mighty. It sold for about \$7 per shifter (per side), and was largely ignored until it became the shifter on the early top-notch mountain bikes—the Ritchies, Breezers, Trailmasters, and so on. Even then, it was seen as too crummy for the bikes it was going on, but it was the only thumb shifter available, and it did work well.

As the name suggests, there's a ratchet inside. The ratchet lets you set the wind-up tension light without the shifter slipping under the tension of the derailleur springs. Without this feature, you'd have to set the tension high enough for friction alone to prevent the derailleur from slipping out of gear, and the amount of friction necessary to do that would make shifting itself harder than necessary. That's the way it is on pure friction shifters, like the old Campagnolo ones all the pros and most enthusiasts rode on pro-level bikes around that same time.

In about 1977, SunTour put a Power Ratchet in its first handlebar-end shifter, used on virtually every good touring bike in that touring bike heyday. It became far and away the most popular and widely used bar-end shifter ever made. The same mechanism also made its way into many great-shifting, inexpensive SunTour shifters in the early '80s.

That original version of the Power Ratchet worked fine, but in the 1986 model year (meaning it was developed in 1985), SunTour introduced a new version, with a lighter action, finer ratchet, and used it in its Sprint and Superbe Pro models. This next version improved on something that seemed perfect already. But timing is everything, and just a year later indexing swept over the cycling world.

So there sat SunTour with this perfect shifter, while the market was going ga-ga over indexing. Compared to the narrow, confined working environment of an indexed shifter (gotta use a special chain, derailleur, freewheel, cable housing, and so on), SunTour had a shifter that not only was the lightest, smoothest-action shifter ever made, but it worked with any derailleur, chain, and cogs. It still does. It's unlikely that in our lifetime anybody will ever make a drive train that can't be shifted wonderfully with this mechanism. But bad timing is bad timing, and that's what sunk it.

We bought a huge stock of shifters with this mechanism cheap many years ago, sold them like popcorn, and finally ran out a year and a half ago. SunTour didn't want to make them again, but Dia-Tech did, and with SunTour's generous cooperation and technical assistance, Dia-Tech made us the Silver shifter, with the exact mechanism we've been raving about here. Our timing is no better than SunTour's was in 1986, but our needs are smaller. We aren't after the mainstream rider who talks tech and dreams of racing, and we don't have to sell thousands of them.

Like any non-indexed shifter (or radio that uses dials, for that matter), it isn't as rookie-friendly as finely tuned indexing. There's a short learning curve with friction (non-indexed) shifting, but my oldest daughter had it mastered in a few days when she was 11, with virtually no outside feedback or coaching whatsoever.

You'll master it almost immediately, and once you do, you'll shift faster and more quietly. You'll be free of the frustrations of having to match up the drive train parts. You can put it on any bike and shift away. It frees you and gives you more control, and many folks find it far more satisfying. Don't fear friction shifting—it's simple and fun!

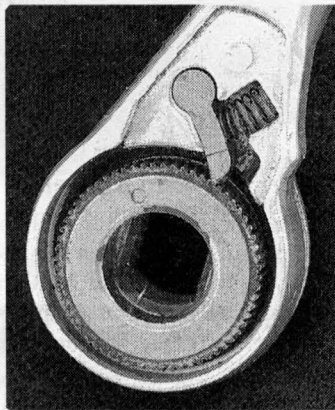

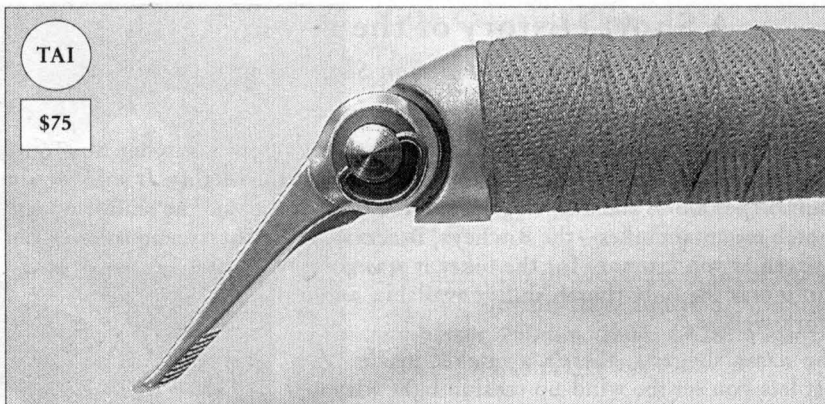

### Silver Bar-End Shifters

These are the best bar-end shifters you'll ever set a hand on. There's nothing like them, and if you think your old SunTour barcons are the bee's knees, bless you, but you're living in dreamland. Their magic is the Power Ratchet inside, which we tell you all about on page 59. The shifting is smooth, light, simple, fast, and precise. Indexing, in comparison, seems raucous and archaic.

These shifters work with almost every derailleur, and freewheel, cassette, chain, etc., so you'll never be midway between gears and powerless to do anything about it. There's a short learning curve, but don't let that scare you. Everybody learns fast with these. When you buy these shifters, you also get cables, housing, end-caps, shifter boss adapters—all you need to get set up with bar-end shifters. Shifting can't get any better.

Silver Bar-End Shifters: 17-089 \$75

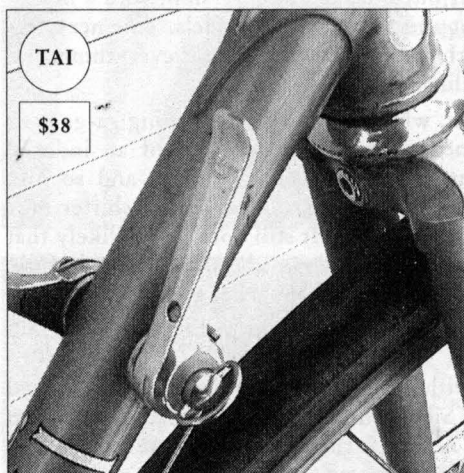

### Silver DT Shifters

Riders who still use downtube shifters wouldn't think of using anything else. They're light, out of the way, accessible enough, and they clean up the handlebar area, making bar-stem-tape-brake lever switches quick and easy. Plus, they don't tempt you to shift too much. These are the best downtube shifters ever made. At only \$38 per pair, they're the biggest shifter bargain in the hemisphere. If you try and can't handle downtube shifting, convert these to bar-ends with the pods below.

Silver DT Shifters: 17-101 \$38

### Silver Pods!

These allow you to mount most downtube shifters as bar-end shifters. If you already have Silver DT shifters, or SunTour Sprints, you'll need these to convert them to bar-end shifters. These are neat and smart, and ours alone.

Silver Shifter Pods: 17-068 \$25

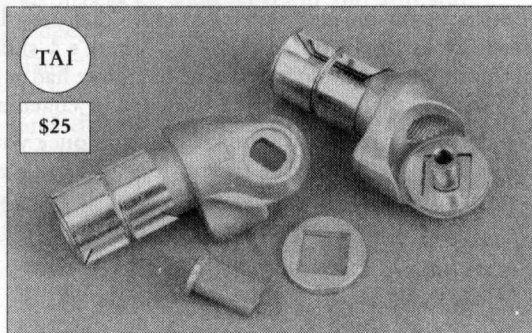

## Downtube Cable Stops

When your bike has downtube shifter bosses (as all of ours and most others do) and you want to use something other than downtube shifters, then you need these cable stops to hold the housing. They slip right over the brazed-on stops and bolt on. Couldn't be easier, and there's no substitute for them. The stops we have are made either by SunTour or Shimano.

DT Cable Stops: 17-045 \$14



JPN

\$14

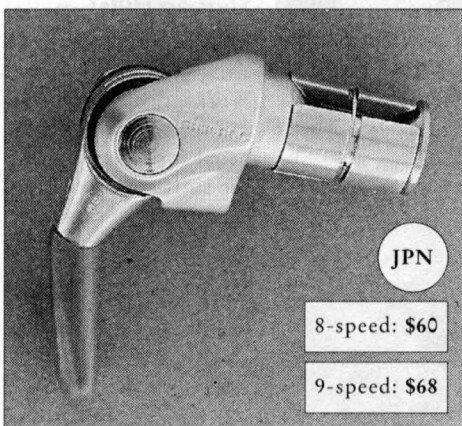

JPN

8-speed: \$60

9-speed: \$68

## Shimano Bar-Ends

Shimano's best bar-end shifters, indexable with 8- or 9-speed cassettes, and with a friction mode, too. If later on you want to get our Silver shifters, you can just bolt them on to these and be happy. No need to buy any additional hardware. Great for touring, commuting, anything, and they also convert to thumb-shifters when you mount them onto Paul's Thumbies. Which we've got, of course.

8-speed: 17-098 \$60 9-speed: 17-049 \$68

## Shift less this year than you did last year

Riders who use shifters built into the brake levers often say, "Now I shift so much more often!" People with remote controls change television channels more often, too. Frequency isn't the goal. Shift whenever it feels right, but there is satisfaction in grunting just a little to crest a hill, and there's refreshment to be found in pedaling both slower and faster than the textbook range of 95 to 100 rpms.

For a lonely rider on a homely road, there's a case to be made for grunting five-percent harder or spinning four-percent faster to get past the harder or easier part. It's a more natural way to ride. Today's interest in single-speed riding is a backlash against more gears and ever-increasing pressure to shift at the slightest provocation. These riders find it liberating to not even have the option to shift. If you need a role model, there's Lon Haldeman. Lon has won RAAM a few times and continues to ride 15,000 miles or so a year by himself and with his PacTour groups, and rides a derailleurless bike with a single chainring and three cogs in back. He rides it everywhere, over all terrain. And there are thousands of others out there who, like Lon, have figured out that constant shifting isn't all it's cracked up to be. Bar-end shifters are plenty convenient, but just not too.

## Friction Shifting in an Indexing World

*Why do it at all, and the Best Way to Learn How*

### Why

Friction shifting works with every derailleur, freewheel, cassette, and chain made. You can mix and not even match parts from different companies and different decades. It's liberating.

You have a direct link to the movement of the derailleur; and it's both easy and satisfying to do that. It's control.

Our survival as a company doesn't depend on our ability to persuade riders to shift in friction. But friction has a lot to offer, and is easy, so you ought to give it a try.

Don't you doubt your ability to shift without indexing. Riders did it for most of a century, with much worse derailleurs than we have now. My 11-year-old does it flawlessly since she was eight. That's her at 8 there in the photo.

### The Best Way To Learn

1. Find an open area and pedal in a medium gear. Any cadence.
2. Every two or three seconds, shift across the full range of cogs, not even stopping in between. Do that for a minute or so. Don't shift out of need, because there is none. Shift as though you're trying to wear out the shifters.
3. Try to mis-shift. If you successfully mis-shift, you'll hear the chain clicking and clacking between adjacent cogs. Once you do that, either push it back the way it came, or push it more the other way, until you're perfectly in a gear. That's called "trimming."

This intentional mis-shifting routine will show you that it's a lot easier to hit the

gear than it is to miss it; and when you do miss it, it's easy to correct it. But you'll be amazed at how infrequently you'll even need to trim the shift. I can't count the number of times I've found myself toting a load with one arm and having to shift with my foot (it's easier with downtube shifters than with bar-end shifters). Even with foot-shifting, I rarely have to trim.

### The 1-2-3 Way to Shift on Hills

Shift before your pedaling gets really slow. With indexing, you can wait too long, pedal too slowly and the shift still takes. Whether you consider this a technological advancement or a quick way to learn bad habits, well, it just depends upon your approach to life. But that's the main difference between indexing and friction.

If you're grinding slowly up a hill and suddenly find that you need to shift:

- 1) Point your bike across the road (traverse) to lessen the slope.
- 2) Pedal hard for a stroke to get up a small bit of speed.
- 3) Pedal lightly and shift.

It requires a small amount of skill, but the skill comes quickly and stays with you the rest of your life.

Neither Campagnolo Ergo nor Shimano STI shifters have a friction mode. They both work well, and if you love 'em, great. But their lack of a friction mode limits their use with out-of-series drivetrains, and makes them vulnerable to less-than-ideal conditions. And you can't shift either with your foot!



Impromptu double-shift by eight-year old Anna, who has used indexing but prefers friction...as does her big sister (and with no pressure from Dad).





TAI

\$12

### Cheap Good Thumb Shifters

The only thumb shifters still made are super cheap ones from SunRace or Falcon (as available, both from Taiwan). That's not such a bad deal, though, because yep they're cheap, but they're also reliable, durable, inexpensive, and they work great. No indexing, just friction, which is how we like them, anyway. Sold by the pair, as with all our shifters.

Cheap Thumb Shifters: 17-097 \$12

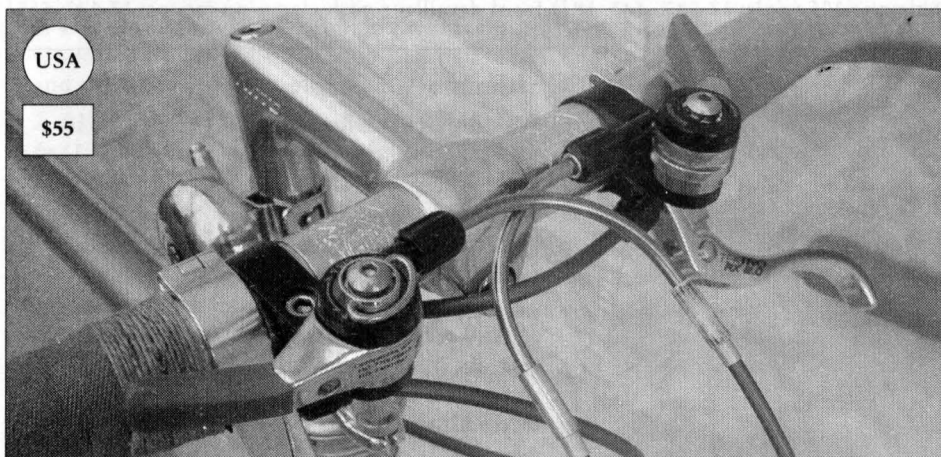

USA

\$55

### Paul's Thumbies

These aren't shifters, they're shifter holders. You can barely see them behind and under the mounts there. That's what you get. We show them with extra noodles (those curved aluminum tubes), but they don't come with them or need them. Just the mounts is all you get. They hold Shimano bar-end shifters in the thumb-shifter position, so you can still shift and index and all that with Shimano thumbshifters, even though Shimano stopped making them. It's a clever idea, a smart idea, a thoughtful one, and the world's a better place for these. They'll also work with Silver downtube shifters.

Stock, right from the box, you can mount them on Albatross bars or any mountain bike bar. But Mark here has a fine time mounting them onto center sections of drop bars, and that's a fantastic way to go, too. If you use a handlebar bag and a computer and have already taken up much of the available space near the stem, better put your shifters elsewhere. Otherwise, these are great. It's hard to ride them and not want them. Good idea, Paul.

Road bar thumbies for 26mm bars (all except Albatross and Dove): 17-124 \$55

Mountain bar thumbies for 22.2mm bars (Albatross & mountain): 17-128 \$55

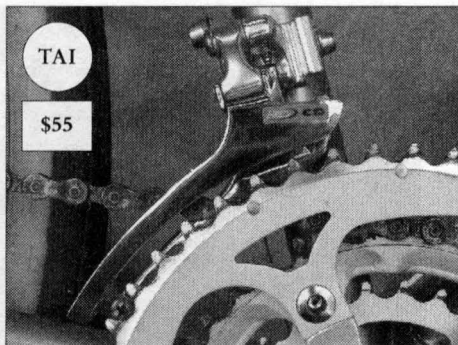
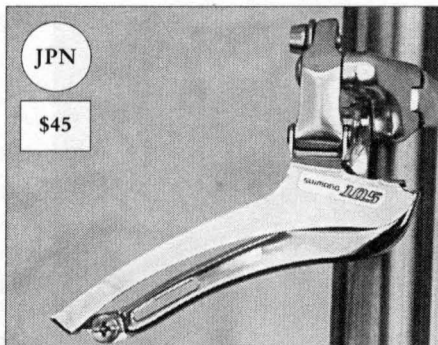

## Two front derailleurs

Front derailleurs have the easiest job on the bike, and it's so hard these days to design a bad one, that nobody does it. Shimano has the best drive-train engineers in the world, and you can bet that any Shimano front derailleur works fine. The Shimano 105 triple fits on all of our bikes and works for almost anything. It clamps on 1 1/8th-inch seat tubes (steel normal).

The IRD compact model on the right is made in Taiwan using the same materials and technology that Shimano and everybody else uses for fronts. It's designed specifically for "compact doubles"—two chainrings, where the biggie is 50t or smaller, and the small one is 34t or bigger.

Shimano 105 triple: 17-082 \$45 IRD front derailleur with clamp-on mount: 17-122 \$55

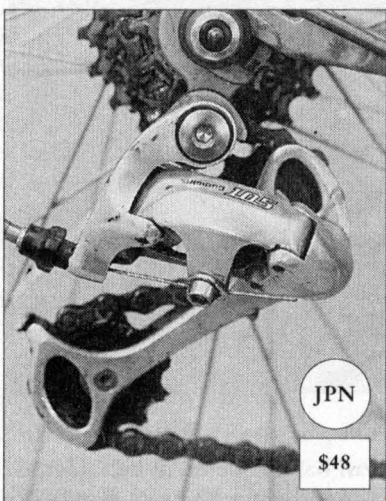

## Shimano 105 Triple

For three chainrings and up to 28 teeth in back. This year's version is shiny silver, looks great, and given all that, it's hard to justify anything fancier and costlier. Shimano rates it to 27t in the rear, but it goes to 28t easily. Shimano's 105 parts group is the best value out there, and the derailleurs are the best part of it. We believe this is the top value in a road rear derailleur today. Beautifully styled, shiny and silver, and it shifts predictably and perfectly all the time. Prices went way up this year, but it's still worth it. If our price goes down, yours will too. It could happen.

Shimano 105 R. Triple: 17-059 \$48

Super long der. cable, each: 17-090 \$4 each

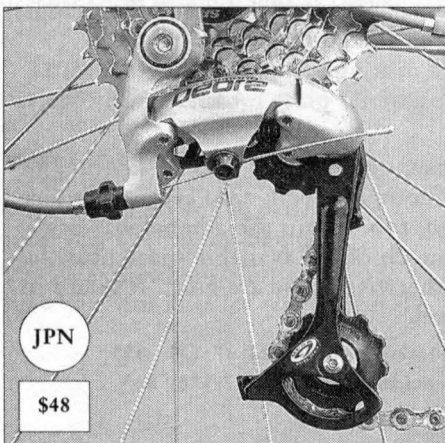

## Shimano Deore

For rear cogs to 34 teeth, you won't find a better shifter than this one. Fancier and more expensive, yes, but not better. It's a strange champagne-y color and has a black cage. This is the model we put on most Rivendell All-Rounders and all Atlantis bikes. As with the 105, our price is as low as we can go, but you might beat it at one of the cheap places.

Shimano Deore: 17-088 \$48

Super long der. cable: 17-090 \$4 each

## A Case For The Clamp-On Front Derailleur

The clamp-on style makes it easy to raise and lower your derailleur on the seat tube. This isn't something you have to do a lot, but if you've been pedaling around with a 53-tooth chain ring and finally decide you'd rather have a 46t or 48t big ring, a clamp-on style makes the change easy; and if you have a braze-on front derailleur, you won't be able to lower it enough to accommodate the new and smaller chain ring. You may have a \$3,000 frame on a \$5,000 bike, and you can't even ride the gearing you want to ride. That's not tragic, just pitiful.

Before you get any new frame, think about this: Having a front derailleur braze-on offers no functional benefit, and limits your choice of chain rings. If you're getting a custom bike made, and you insist on a front-derailleur braze-on, then make sure the builder puts it in the right spot for the chain rings you're most likely to ride. Good luck.

## Flash! We have bicycles and frames, too...

If this is your first catalogue and nobody has told you otherwise, you might not know that we have bicycles, too. We do, we have from the start, and they're all lugged steel. We have lots of information about them on our site, [rivbike.com](http://rivbike.com), but here's a brief rundown of our models and plans:

1. **Custom Rivendell.** We design them according to your needs and body, and Curt Goodrich builds the frame. Joe Bell paints it. The lead time is roughly 500 days, and the cost is \$2700 per frame. There are none better.
2. **Atlantis (touring, trail, commuter).** Our most popular frame still. Hand-made in Osaka by Toyo, a 5-person frame company. Head builder: Tetsu Ishigaki. Sizes from 47cm to 68cm. Frames are around \$1400; bikes run around \$2700 to \$2800.
3. **Rambouillet (road bike, sidepulls).** Our interpretation of an all-round, speedy-yet-useful, supremely comfortable road bike. Made by Toyo, in Japan. Sizes 50 to 68cm. Frames are the same prices as the Atlantis. Bikes are about \$2300 to \$2500.
4. **Saluki (road, touring, all-around).** Designed for 650B wheels, which scares off 90 percent of its potential market. But what a bike! Same price as Atlantis, etc.
5. **Glorius & Wilbury (mixte style).** The most comfortable & beautiful mixtes we've seen. 650B wheels. Sizes 50, 52, 56, 58cm. \$1500 frame, \$2700 to \$2800 bike.
6. **Bleriot.** Just like a Saluki, but less expensive and only slightly less frilly. Another great, all-around useful and comfortable bike. Lugged steel like always, but it's our only bike that's made in Taiwan, which accounts for the low price: \$750 frame, about \$1900 for a bike, depending on the parts.

We've made frames for our entire history (12 years), and in many ways, and in most ways, the frames are what we're all about. Every frame designer or maker has a bias in his or her frames. Our goals are comfort, clearance, and beauty.

We design the frames and fit you so you can get an ideal, comfortable riding position. Many of our customers come to us owning half a dozen or more bikes already, and then get one of ours, and ka-blam—they're comfortable for the first time ever. It's not luck or magic; it's just the result of a logical sizing and fitting method, and a good frame design.

All of our bikes have good tire and fender clearance. Tire volume determines the loads and surfaces a bike will be good for, and all of our frames accept the widest range of tires possible within their specialty.

Beauty sort of speaks for itself, but is more subjective than most frame qualities. Maybe it suffices to say we like bikes that look a certain way. The proportions have to be right, and the clearances, and curves. The whole package should look right.

## Is Backwards Shifting Better? Yep, but Just Slightly.

The derailleurs shown below look normal, but work oppositely. The pulleys are relaxed when they're below the *large* cog, not the small one. Shimano calls this "Rapid Rise." We'll abbreviate that as RR. Shimano says RR is more logical, easier, more intuitive. They're right.

Especially with bar-end or down-tube shifters. In both cases, you push the left and right shifters forward to get an easier gear, and pull them back to get harder gears. It just makes so much sense.

Many of you have learned the other way, and have no problem with it. You have little to gain by changing, but less to lose by it than you think. The first week or so you will mis-shift plenty, but your head doesn't blow up when that happens, and the feedback is so immediate that you correct it right away without missing a stroke. It took me about a month of increasingly rare and always inconsequential mis-shifts before I reached the point where I hardly ever mis-shifted, and now I prefer it. If you're up for a new experience, try it. You don't often get an opportunity for such a restart on something that's become so familiar. Rapid Rise derailleurs won't take over, but they make more sense. — Grant

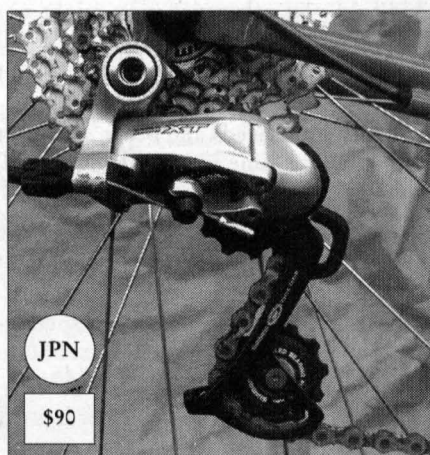

XT Short cage RapidRise: 17-117 \$90

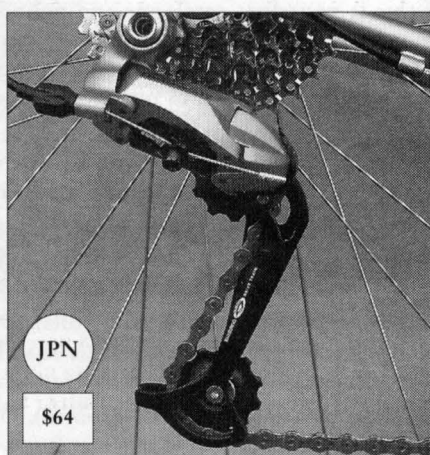

LX Long cage RapidRise: 17-119 \$64

### Which One to Get (all about Chain Wrap)

Both models shift up to 34t, work great, look fine. The short-cage XT won't "wrap" as much chain, so if you ride in the small front ring (say, a 24t) and a tiny rear cog (less than 18t or so), the chain will be slack. It's not the kind of thing that'll jack you off the bike, but it might make you lose composure and crash. If you can limit your small chainring use to the four largest rear cogs in the cassette, it's fine — and you get more ground clearance.

To figure out which to get: Subtract the number of teeth in your small chainring from your big front ring. That's X. Then subtract the smallest rear cog that you'll use with the small ring from the largest rear cog. That's Y. If  $X+Y=33$  or less, you can get the XT shorty. If it's more than 33t but less than 46t, get the LX longy. Example: Crank has 48x36x26 rings. Rear cogs are 11x32. Okay now:  $48-26=22$ . And  $32-11=21$ . Since  $22+21=43t$ , go with the XT. BUT if you can limit your 26t chainring to a 21 or bigger cog, then  $32-21=11$ , and  $22+11=33$  — presto, you can ride the shorty.



USA

\$100



USA

\$30

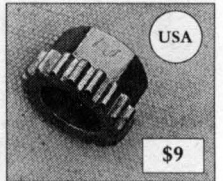

USA

\$9

### Phil Wood BB

Maybe the best. Machined from 17-4 stainless, a better and more expensive material than most others use, and you'll likely get 25,000 miles on it. When it needs servicing, send it back to Phil, and they'll do it for about \$20 to \$25. You also need the retaining rings (below), and a tool (also below). Two tools make it easier, so get two. Other sizes available on special order. Call first.

108: 12-045 119: 12-050 123: 12-051 125: 12-140

### Phil Tool & Rings

These screw into your frame and hold the Phil bottom bracket in place. We list British only, for American and Japanese and most non-Italian frames.

Phil tool: 19-035 \$9 British: 12-053 \$20

### Cartridge Bottom Brackets by Shimano or Tange

An excellent, trouble-free bottom bracket and a great value. It installs easily, is sealed, and you'll likely get 15,000 miles out of it. We can't say they'll work for sure with a crank you have...but if it's a Japanese crank with a square taper and the current spindle seems about the same length as the ones here, it's a good bet. They work great with the Sugino XD-2. Sizing:

Road bikes with two chainrings and no bowed-out chainstays: 107mm 12-191  
 Road bikes with three chainrings and no bowed-out chainstays: 110mm 12-192  
 Any bike with bowed-out, but not ultra bowed-out chainstays: 113mm 12-243



\$40

\$10

### BB Tool for the above bottom brackets

It fits into the recessed splines of the UN-73 and UN-53 and other Shimano and Tange bottom brackets so you can install, tighten, or remove it. You can use a big adjustable wrench on it, or a ratcheting socket wrench.

BB Tool for Shimano: 19-055 \$10

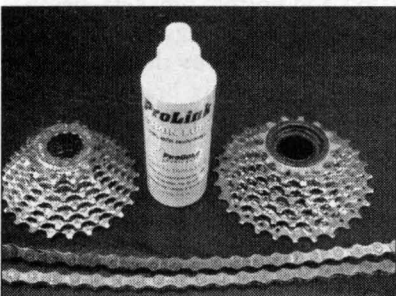

### Cassettes, Freewheels, Chains, Lube

These are the grimy parts of a bike, so no use going to Great Lengths to acquire The Perfect One. Just decide between freewheel & cassette, pick a gear range you can live with, then get a reasonable chain. Our selection is small, so choosing is easy. Chains are SRAM or Shimano. Cassettes are Shimano-compatible, usually but not always Shimano. They're all good.

As for chain lubes, there's no need to use anything besides ProLink. It treats the metal to resist wear, it lubricates, it doesn't get all black, and it's cheap. The best we've used. If you're lazy, spray the chain with Boeshield (on another page).

8sp cassettes 12x24: 13-048 11x28: 13-049 11x32: 13-050 \$30  
 9sp12x27: 13-064 \$55 Chains 7/8sp SRAM: 13-047 \$15 9sp SHIMANO: 13-031 \$21  
 7/8sp SHIMANO: 13-074 \$20 ProLink chain lube: 13-051 \$6

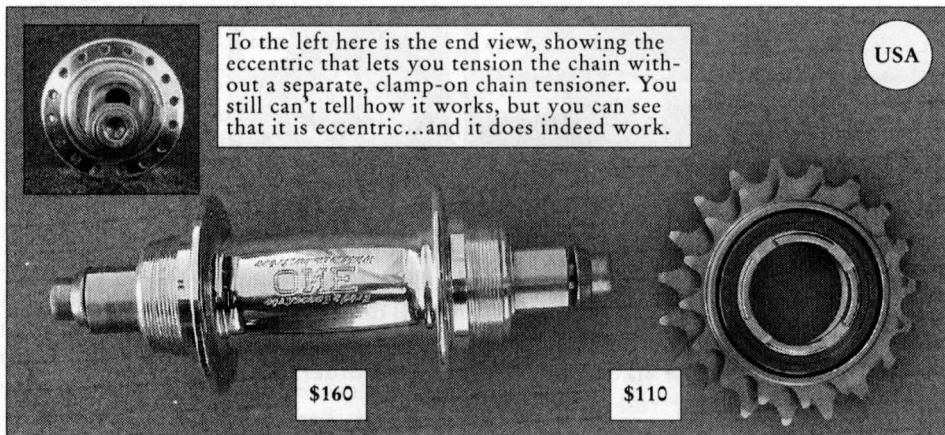

## Two exceptionally clever & useful things from White Industries

1. DOS, a two-cog freewheel for Quickbeams and other single-speed bikes. Machined, precise, smooth, sealed, quiet, perfect, and pretty. After seeing that it costs \$110, you might think it wins the prize for the most dollars per cog of any freewheel ever made, but you'd be wrong there; White Industries also makes a single-speed freewheel that costs about \$80. If you ride your derailleur-less bike a lot and in hilly places, it's a good toy. Changing gears with hands is a cinch.

2. ENO rear hub, with a built-in eccentric so you can convert any bike with vertical dropouts into a single-speed. Just as well-made as the freewheel, and Rich here can build the wheel for you. Email [rich@rivbike.com](mailto:rich@rivbike.com) for details and prices.

DOS two-cog freewheel: 16x18: 17-082 16x19: 17-083 17x19: 17-084 \$100

ENO eccentric rear hub: 130mm x 32H: 18-231; 135mm x 32H: 18-232 \$160

## Crank Design and Gearing

1. Instead of 53t/52t big rings and 42t/39t inner rings, try something like 48t/46t big rings and 36t/34t inners. This is much more useful and friendly gearing for anybody who doesn't race. For hills and dirt, add a 24 or 26t inner ring and a 28t to 34t cassette, and you're ready for anything. You won't have to think about gearing again.

2. The small (46 to 48t) and the smaller (36t or 34t) middle ring give a lower gear, so you stay in them longer before shifting to the granny.

3. A 30t inner ring on a triple is dumb. You aren't dumb to have one, but it's dumb anyway. If a bike part can be dumb, that is. If it can't, then ok.

4. The media sometimes calls square-taper cranks obsolete, old-fashioned, inferior. They aren't. We still much prefer square-taper cranks and bottom brackets, because they let you adjust the chainline (outboard position of the chainrings relative to the bottom bracket). With a splined system, you can't adjust. If you buy their crank and their bottom bracket, there's no need to, but it's common to mix brands between cranks and bottom brackets, and without a way to adjust, it's harder to do that.

5. Silver cranks with polished or anodized finishes seem to be harder and harder to get. It's cheaper to make a black crank, because it means less preparation before the finishing—you just paint it black. It covers surface flaws that don't hurt a crank, but would make it look lousy. We'll offer only silver cranks as long as we can get them.

6. Campy came out with a 110mm compact double, but made one of the chainring bolts slightly different, so you can't use any other 110mm chainring on it. That's not helpful or in your best interest.

7. Sheldon Brown has come up with a better way, called Gain Ratio. It's a much more logical system than anything else out there, but has the disadvantage of having been born rather late in a game where logic doesn't always count. If you want to read about Gain Ratio, go to [www/sheldonbrown.com/gain.html](http://www/sheldonbrown.com/gain.html). —GP

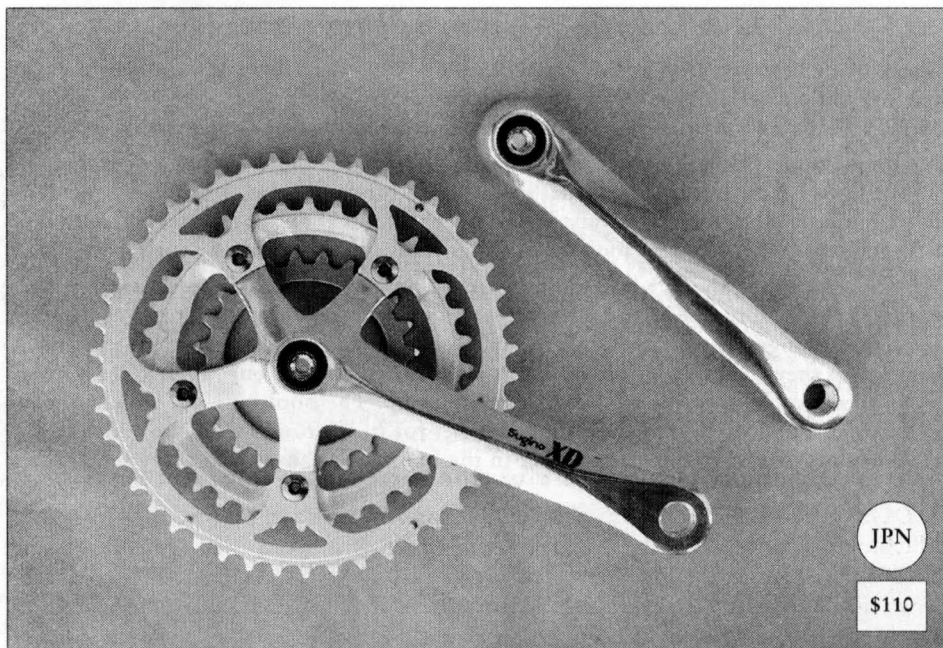

## Sugino XD2 Triple

*The best value ever in a triple crank.*

This is the smartest and most versatile triple crank on the market, and is almost too smart and all-around good to even exist in these weirdo times. It's possible that Sugino wishes it could wipe it out with a new "modern-style" crank, but hasn't the resources to do that yet. So for now, everybody with a decent job should dig deep and buy at least two of them, just to encourage Sugino to keep making it.

It has about a 161mm to 165mm Q Factor (outside-to-outside width), depending on what length spindle you put it on. In the old days we'd consider that wide, but by modern standards it's smack dab medium. On road bikes with straight (normal) chain stays or is an Atlantis (one of ours), mount it on a 107mm bb. If your bike has bowed-out chain stays like most mountain bikes, it'll need a 113mm. Unlike most cranks, it also comes in a 165mm arm length. At only \$110, it is a shocking deal. 110/74 bolt circle with 46x36x24 or 48x36x26 rings rings.

165mm 46/36/24: 12-231    170mm 46/36/24: 12-167    175mm 46/36/24: 12-190    \$110  
 170mm 48/36/26: 12-258    175mm 48/36/26: 12-259    \$110

### How Long the Cranks?

In the pre-mountain bike days, no crank maker in the world would think of NOT offering cranks in lengths down to 165mm; and 2.5mm crank length increments were standard on better cranks. Today, probably 90 percent of the cranks available come in 170mm and 175mm only, and those large makers in a position to demand a wider range don't see the need. They should be ashamed.

You might think that the crank makers would offer it, but they don't make what there's no demand for. What's involved in another crank length? Not much. A new mold costs about \$10,000, and the same mold can work for a 5mm to 10mm difference in length, just by drilling the pedal hole in a different spot. It wouldn't be right to whine without noting the exceptions: Campagnolo, Shimano Ultegra and Dura-Ace, TA, and this Sugino come to mind. It's unlikely that the shortage of shorter cranks will continue. Common sense ought to win sometime!

## Our Dearth-o'-Nines Pricing Strategy

Many of us here feel that nothing, but nothing, wins the "Make it seem like a cheap trinket while simultaneously insulting the customer" award like a price that ends in \$0.99. The higher the price and the more 9s there are in the price, the worse it is.

No doubt studies have shown it to be effective—probably more so than prices that end in \$0.95, which to us are just a gnat's hair more tolerable—but who does it actually fool? Fools, is who! Non-fools just round up, and fools should be protected, not taken advantage of. We say this as fools and former fools, speaking for all fools, if we may.

We're even careful about whole-dollar prices that end in 9, and in ten years of catalogues, I think only one of them has slipped in, and it was a mistake, and changed in the next catalogue. Prices that end in \$0.50—we have no problem with them, and in some cases they'd make a lot of sense, but we're trying to keep our "even dollar" streak alive, so we sometimes round down, sometimes up. The books we sell almost always end in \$0.95, and we don't berate the publisher for it. We round those up a nickel, and that may make us the high-price leader in the book world, but what's five cents?

### Our Guarantee

We won't sell it to you unless we know from personal experience that it's good. We don't exaggerate any claims. Every now and then, except in Nitto's case, a flawed something slips through from an otherwise reliable maker. Truly defective merchandise is rare, and defects that show up after extended use generally aren't defects...however, if after extended use, you find yourself dissatisfied with something, tell us why and we'll do our best to make it right. Over the years we've come upon some interesting folks whose recreation centered around returning merchandise, which forces us to say: We reserve the right to not sell to you, if we suspect we're just playing catch. But for the rest of you, we want you to be happy, and will do all we can to make sure that happens. You may return any item within 30 days of purchase for a refund, exchange, or credit, as you wish. After 60 days the refund's out, but you can still exchange it or get credit. You pay the postage on any return, and we'll pay ground postage on the way back.

### What are we missing?

You know the kinds of things we like, and our customers like. Can you think of something we ought to carry? It should be currently made and readily available, not a local feller's sideline hobby when he gets around to feeling like making one or two. We're most interested if it does something, no matter how unimportant that thing might be, better than anything else on earth. And we need good delivery. Let us know. Thanks.

#### This is a \$10 Coupon

It is actually worth \$10 on any order over \$10 between now and December 31, 2006. You must cut this out and mail it in. No phone use, no faxes. It has to be this actual piece of paper. Thank you. Members or non-members, this time it doesn't matter. Print clearly.

Name \_\_\_\_\_

Address \_\_\_\_\_

City \_\_\_\_\_ State \_\_\_\_\_ Zip \_\_\_\_\_

Telephone \_\_\_\_\_ Email \_\_\_\_\_

Send it in with the order form, also in this catalogue. The order form can be a copy.



## Tips for Happy Riding

---

Learn right away that the front brake is the most effective one, and to never lock the front wheel. Learn how far you can lean over without scraping a pedal. Learn to keep the inside pedal UP when you corner, and learn to ride safely in all conditions. Signal your approach to pedestrians, especially if they're old, and a bell is better than "On your left!" If no bell, try clacking your brake levers. If all you got is "On your left!" that's fine. At least one ride in 10, go without your sunglasses and gloves. Sometime next month, put some double-sided cheap-style pedals on a good bike and ride in non-cycling garb. Carry an extra tube you can donate to somebody with a flat tire and just a repair kit. If you're a guy, don't try to be a mentor to every female cyclist you meet. Don't ride in shoes you can't walk through an antique shop in. Don't wear clothing that makes your sweat stink even more. Don't think you'll go faster in a significant way if you and your bike become more aerodynamic. Put a \$20 bill inside your seat post or handlebar and hold it there, somehow. Don't ride until you're confident you can fix a flat. If you ride more than one bike, have a set of bring-along tools for each one. Learn how to remove your rear wheel (put the chain onto the small cog, etc.). If you ride in a group, bring food for you and somebody who forgot to. Go for a one-hour ride underdressed sometime, because it's good to be really cold on a bike every now and then. Never blame your bike or your health or anything else if you're the last one up the hill or in to the rest stop. If your brake hoods are black, wrap your bars with a different color tape. Never let your chain squeak. If you pass another rider going up a hill, say more than "Hi," but if it's a woman and you aren't, don't assume she wants to chit-chat. If you're a woman and it's a guy, you can chit-chat all you like. If you see another rider approaching you from the rear and trying to catch you, let it happen. Fun is more important than fast. Don't put any cyclist up on a pedestal, except Lon and Freddie. Bring normal food on your ride. Take photos on your rides and give them away. Feel comfortable mixing high tech and low tech, old and new parts and technologies, and don't apologize to anybody for it. Compliment other people's bikes, especially if they're new. Buy the cheapest helmet that fits well. Try seersucker shirts for hot weather riding, and long-sleeved ones are best. Don't underestimate fig bars. If you get a new widget and like it, don't "swear by it," just use it. Don't always shop by price and never ask for discounts at your local bike shop. Every time you go into a bike shop, spend at least \$2, and if you ask a question and get good advice, spend \$5 (get a cable). If you buy a rack, don't ask for free installation. Don't assume your bike shop is making money. Ride only when you feel like it. If you know a fast new rider, don't say, "You really ought to race..." If you see a stocky woman rider, don't suggest she race track. Have at least one bike you feel comfortable riding in a downpour. Ride in weather that keeps other cyclists indoors. Never keep track of your pedaling cadence. If you have a normal loop or ride, count the number of times you shift on it; then the next time you ride it, cut that in half and see if it makes any difference. Learn to ride no-hands and to hop over obstacles, but not simultaneously. Never hit a pedestrian. In traffic, be visible and predictable. If you have several bikes, set them up with different equipment...but always ride the saddle you like best. Don't try to keep up with faster descenders if you're not comfortable descending. Never apologize for buying something that's not quite pro quality by saying, "I'm not going to race or anything." If you buy a stock bike, do something to it that makes it the only one exactly like it in the world. Don't think it's important to match front and rear hubs or rims. If you borrow somebody else's bike, for a short test or a long ride, say something nice about it. Always bring a pump. Build at least one wheel. Wear out something. Don't ever describe any bike, no matter how inexpensive or dilapidated, as "a piece of crap." If you get a fancy bike assembled by somebody else, allow them a scrape or two, especially if the bike is really expensive.



## Going Clipless (Rivendell Style)

Most of the time having your foot attached to the pedal is not a benefit. Experts say it's more efficient, and maybe it is in some circumstances, but it certainly isn't in others, and why the obsession with efficiency? Bicycles are plenty efficient whether or not your feet are locked to the pedals. But when they aren't locked, you'll have more fun. That counts for something, doesn't it?

If pedaling connected made a difference of five minutes per hour of riding, then for certain types of riding (including long commutes) that alone would pay its way. But it makes no more than a few *seconds* difference. This goes against all intuition and what you've been raised to believe, but just try it yourself.

Most riders have tried "step-on" pedals only on the bike they had before they got serious and started riding more. Their switch to click-in pedals coincides with a more rigorous riding schedule, and they attribute their newfound speed and efficiency to the pedals, not the riding itself.

No doubt there are times when being solidly connected is advantageous. On short, steep climbs, it can help you turn the pedals over between 10:30 and 1:30 in your stroke. And a solid connection is good during aggressive riding in wet weather, because it keeps your foot from slipping off the pedal. But for most people, that constitutes about 10 percent of the riding, maximum. What racers do isn't always what you should do. More and more, it's exactly not.

Outside of the peloton, pedaling free is a great way to go. You can mount and dismount more easily, at a traffic light downtown, on a steep climb, or on a tricky trail. You can choose your shoes for the weather, not the pedals. You can walk into a store like a normal person.

Those are convenience benefits. Here's a performance one that Bullseye Cycle's Roger Durham pointed it out to me, years ago. When you pedal with the ball of your foot over the center of the pedal, you're using the muscles you use when you stand on your toes. Not just the foot and calf muscles, but the thigh muscles, too. On sustained climbs and long rides, it's a benefit to be able to shift your foot forward on the pedal, to shift the loads on to different leg muscles. Doesn't it make sense to shift the load to different muscles?

Try it & see how it works for you. You don't have to discard your rigid plastic shoes, or your toe clips & straps. Just wear any old shoes and put step-on pedals on your best bike, and see how it goes for you. You won't hate it, that's for sure.

Pedaling free is the biggest revelation I've had since I learned how to ride a bike. It's easy, natural, efficient, *unlimiting*, and if you can imagine this—it's more fun. Wear any socks, any shoes. Pedal on any two-sided pedal. Get on and off your bike in a flash and noiselessly. Try it for a week & see if you go back.—GP

## Use whatever pedals you like, but most of us like these

The Japanese-made MKS (Mikashima) pedals below are gallant workhorses, incredible values, and can add another dimension to your riding. The concept of being able to ride in any shoes, and being able to get on and off the bike sans shenanigans is as old as the hills and as sensible now as it ever was. You'll ride the bike more. You'll enjoy it more. It'll be more a part of you if you don't have to wear special shoes just to ride it. —Grant

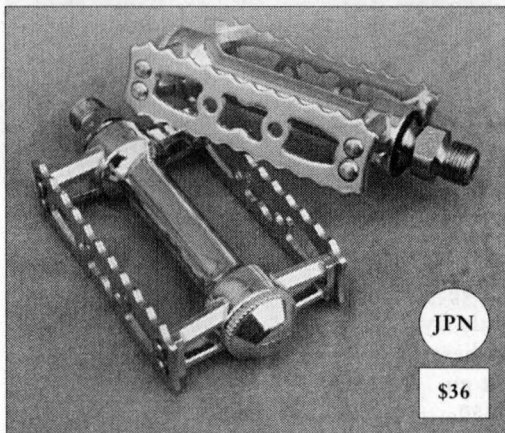

JPN

\$36

### MKS Touring

Our most versatile pedal, and most popular one, too. It's wide, so it supports your foot. It grips shoes, it's easy to flip into, you can ride on both sides, it's great in mud, it works great with or without toe clips, and with almost any shoe, from sandals to Sorels. For commuting, it's ideal. For distance riding, where shifting your feet around can be useful, it's great. Everybody likes this pedal.

MKS Touring: 14-020 \$36



JPN

\$45

### MKS Fancy Touring

Like the pedals above, but at 308g per pair, lighter by 72g; and with a shorter cage for better cornering clearance. We had MKS do that just for us. So if you pedal around corners or tend to be careless, get this one instead. It can't completely protect you from foolish moves, but it is less wide, so the clearance is better. Not compatible with Power Grips, but great pedals, anyway.

MKS Fancy Touring: 14-048 \$45

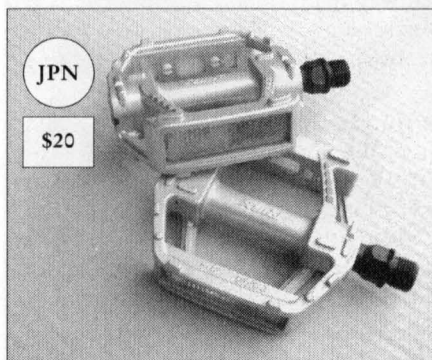

JPN

\$20

### MKS Sneaker Pedal

These win the prize for expectations-based-on-cost-&-looks-&-how-many-riders-ride-'em-these-days -to- performance ratio. The guy I ride with all the time uses these with sneakers, and there's nothing he can't do with that combo, and he doesn't go any slower for it. They're made for BMX riding, so of course they're good with sneakers. The large surface area makes them comfortable with any shoe. The shoe-grip is good, the reflectors are built-in, they require no maintenance but can be maintained, they

spin like the dickens, they're light and don't break, they're made in Japan, and they cost less than fast-food lunches for three. What's not to like?

MKS Sneaker Pedal: 14-047 \$20

## Steel Toe Clips

Most of the steel toe-clip makers of the world have quit making them, and we're at the point now where we aren't too picky, we just get what we can get. We can get really good ones from MKS in Japan, or from Soma (Taiwan-made). No more Frenchies or Italianos, and that's not a tragedy. They were no better, just less committed to making them.

MKS: S: 14-015 M: 14-014 L: 14-013

XL: 14-016 \$11

Soma Large only : 14-051 \$18

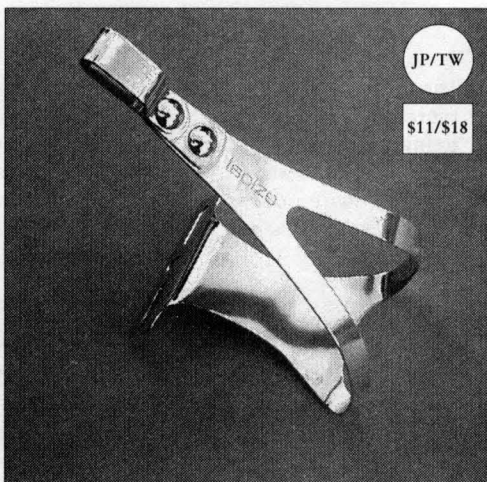

## ALE Toe Straps

It's hard to find toe-straps now, too. We've gone all over. These here are made in Italy by ALE, but they'll probably quit making these, because they quit making the straps that go with them. MKS makes super expensive \$50 straps. Does that sound fun? Interesting, but not fun, says we. Too expensive.

These ALE straps are pro quality, laminated to nylon (a leather-nylon-leather sandwich), and have the shoe-saver pad there, so you won't wreck your wingtips. It's also a cushion.

Yellow only, but they'll fade nicely. Don't be picky about the color now; the toe-strap situation is driving us nuts as it is.

ALE Toe Straps: 14-049 \$13

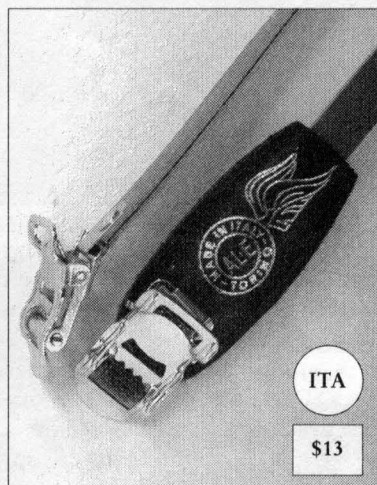

## Power Grips

Originally marketed for people who were afraid of toe clips, they naturally repelled, and continue to repel, experienced gear snobs. But they are a joy to use. They keep your foot on the pedal at all times, and make quick exits and re-entries a breeze. For most of the riding we do, they're just great. They let you ride in any shoe you like, and still allow 90 percent of the freedom of nothing at all. We mount them inside out, to hide the logo. But everybody knows it's a Power Grip, because nobody makes anything else like it at all. Black.

Power Grips: 14-046 \$20

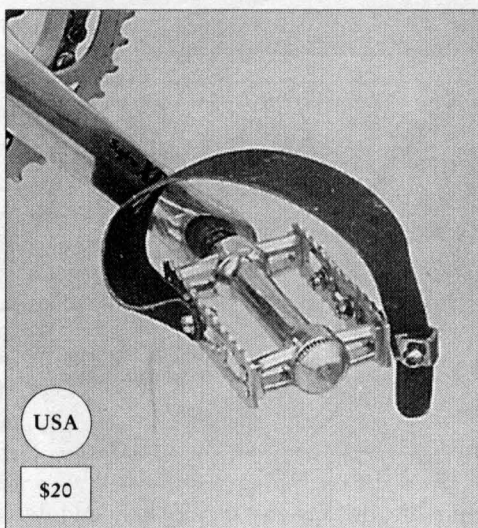

## Brake Design and Brake Issues and the Future

The Dia-Compe Mod. 750 centerpull brake shown on p.76 has the highest function-to-respect ratio of any brake in this catalogue, and likely any brake made today. Centerpulls are so out of fashion, and have been so out of fashion for so long, that old riders associate them early with the first bad bike they ever had; and new riders don't know what to think about them. There are good reasons to like them...

They're easy to set up. They provide lots of tire clearance. The arches are shaped to accept fenders. They work well. The action is a little heavier than the faerie-weight action of a Shimano sidepull, but I put them on my bike and forget they're there. The brake shoes that come with these are not great, so get some Mathausers or Kool Stop salmons. The reach is an issue. These have a minimum reach of 62mm and a maximum reach of 78mm, so you can't just retrofit your modern road bike with them, because they won't meet the rim. These brakes are designed for mid-to-large sized road bikes with fenders, and we make a tourish frame, the Saluki that these work great on. It would be neat if other brake makers would see the good points of centerpulls and remake them in a variety of reaches, but most modern parts makers are too image-conscious for that. The Silver sidepull on p.77 will be a neat brake, too. Things are looking up.—Grant

### Shimano Ultegra 57mm Reach Sidepulls

These go on most Rivendell road frames, and as sidepulls go, they're unmatched. Note that these are the longer of Shimano's two different reaches in this style. They won't fit on typical modern racy road frames, but they'll go right on any road bike built for brake reach between 47mm and 57mm. These work best with sprung (like Shimano) levers. Minimum reach, 47mm; maximum, 57mm.

Ultegra Std Reach Sidepulls: 15-094 \$110

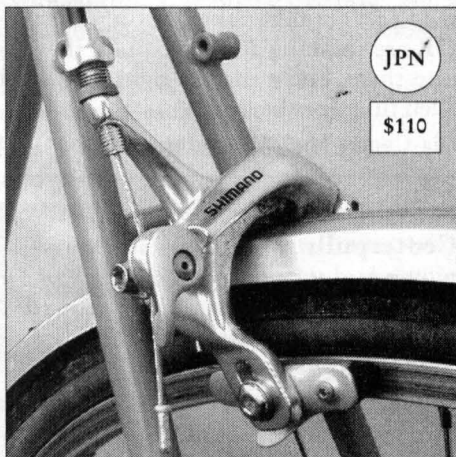

### Shimano's Best Cantilevers

A couple of years ago, a couple of years after almost entirely getting out of the cantilever brake business, Shimano introduced this model, specifically for cyclo-cross racing, but of course equally useful to the 99.999 percent of the riders who don't race cyclo-cross. It sets up relatively easily, is cold-forged, looks great, and stops the bike well in any condition. The brake shoes are "threaded style" and are easy to toe-in with the washers included. There's a spring adjuster on both arms. A nice cantilever brake.

Shimano Cantilevers: 15-116 \$70

### Dia-Compe 62-78 reach Mod. 750 Centerpulls

If you've been riding bikes forever, you still haven't seen these new in at least 25 years; but these are new, made just last year. And, if you're newer than that to bikes, you may never have seen or noticed them.

Well...they're back and we like them. We won't sell many of them—that would require an all-out campaign, and we haven't the time. But they beat sidepulls in clearance, they stop you just fine, and they have symmetry that not only looks good, but works great. The minimum reach is 63mm, so they won't fit on most bikes, but if you have an older road bike with lots of clearance OR are thinking about a Saluki, these are an excellent choice. Don't just dive into them; know they're right for your bike, first. Front allen, rear nutted (with allen filler for the bridge).

Dia-Compe Mod. 750 centerpulls: 15-111 \$45/pr

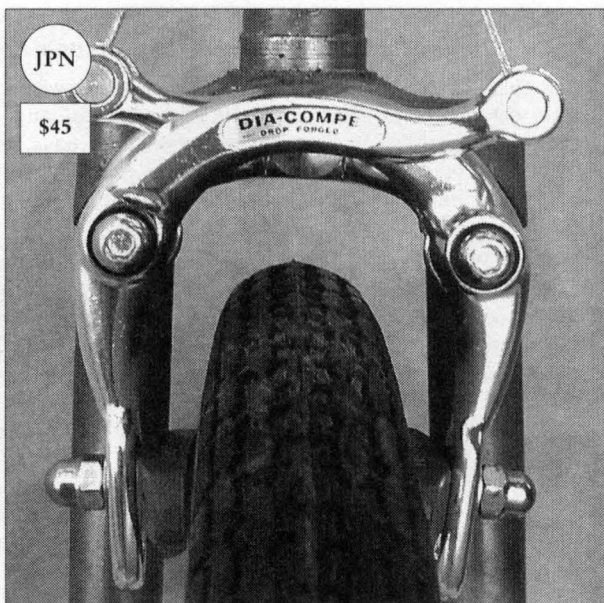

### Paul's 55-70 reach Centerpulls

Paul Price of Chico, California is a rider-machinist who makes fine and expensive bike parts, and he's really come through with this set of centerpull brakes. They're designed for tires between 32mm and 44mm wide, and have ideal clearances and details. Each arm adjusts independently, which itself is no great shakes, but the neat thing is, you can tailor the spring tension light or stiff, as you like.

He based his design on the Dia-Compe above, which is a great place to start, because that's one great brake. But then he made minor changes here and there to optimize everything, and the result is one hellatiously fantastic brake. It's not cheap, but neither is dinner for two and a movie afterwards. If you can handle the initial sticker shock and accept that super fine American-made goods are worth ponying up for, you'll be delighted with these. Make sure your bike has the right clearances for them. They're good for the Saluki and Glorius/Wilbury bikes of ours. Priced per set. Usually you see these priced per wheel, but you need two, so...

Paul's 55-70 reach centerpull brakes: 17-126 \$245/pr

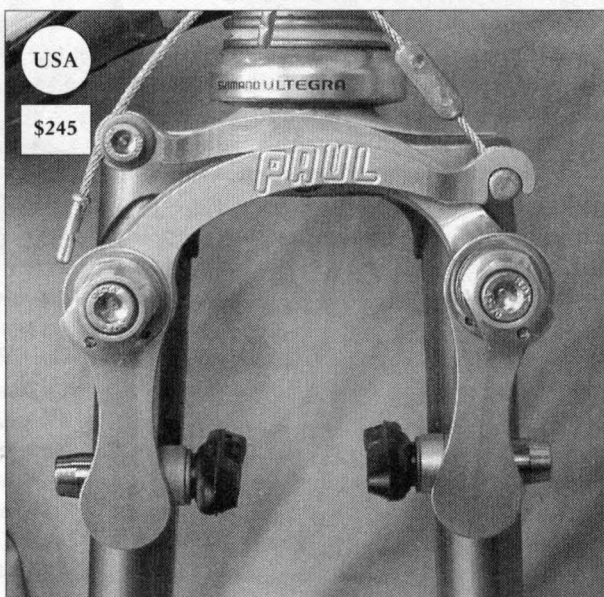

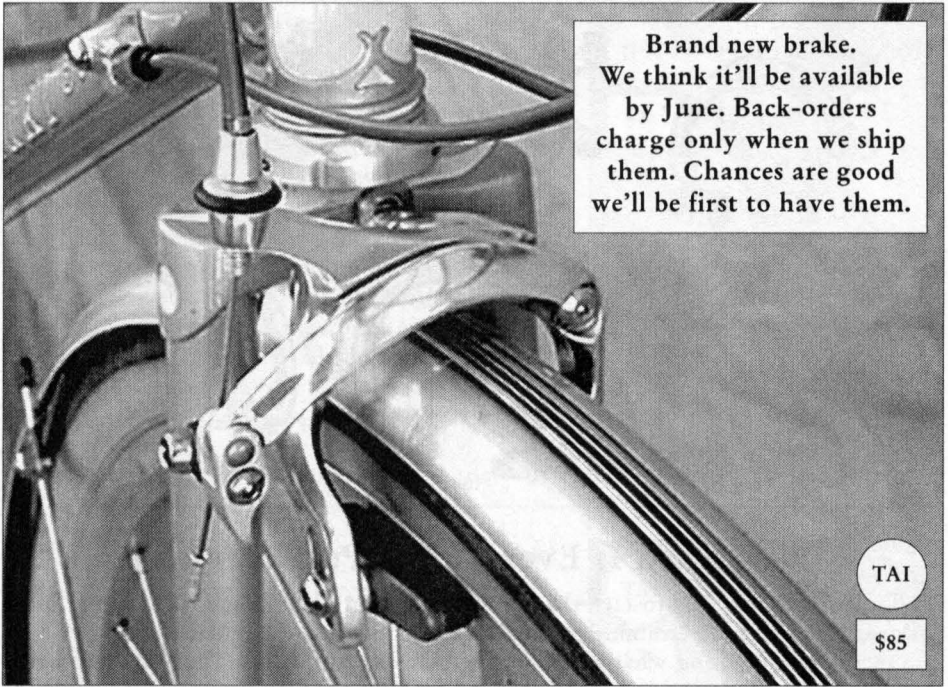

**Brand new brake.**  
 We think it'll be available  
 by June. Back-orders  
 charge only when we ship  
 them. Chances are good  
 we'll be first to have them.

TAI

\$85

## Silver Sidepull

For 32mm to 40mm tires, with or without fenders. Reach: 55 to 73mm.

Here is a brake that could revolutionize bicycle design if product managers understand and take advantage of its dimensions.

The typical road bike uses short reach brakes, which limit the bike to skinny tires and no fenders. But this brake has a minimum reach (brake bolt to brake shoe) of 55mm, and a maximum reach of 73mm. So any frame designed for this brake will be oodles more versatile than any bike made for short-reach brakes. The middle of the slot on this brake is 64mm (73 minus 55 equals 18; 18 divided by 2 is 9; 55 plus 9 is 64). So if you mid-slot the brake shoes on this brake (and you do that by knowing where to put the brake bridge and how long to make the fork blades)—yes, if you do all that stuff, then you can mount a 40mm tire with a fender.

This brake is designed for tires between 32mm and 40mm. It doesn't matter whether they're 26-inch, 650B, 700C, whatever. In the past twenty years or so if you opted for those tires and you wanted room for fenders, you had to get cantilevers (or V-brakes). There's nothing wrong with those brakes, but it's great to now have a sidepull that can do all that, too. In the world of brakes, this is big news, fun news, news-worthy news.

The Silver sidepull came about because we asked Tektro for it, and supplied the desired dimensions and details. It's also available as a Tektro brake (not "Silver"), and if it takes off, those are the ones you'll see around most of the time. I just want to be clear on its origins, because we're proud of our role in it.

It's a dual-pivot brake, quite powerful, and suitable for road bikes, cyclo-cross bikes, tandems, commuters, touring bikes—any bike that uses tires from 32mm to 40mm. The arms are shaped in such a way that they don't squeeze in on fenders. The quick-release opens the arms 10mm, and you can use the barrel adjuster to get another 3 to 4mm. So in most cases it's a cinch to remove and install inflated tires.

The finish is excellent, the brakes are powerful, toe-in is easy. This brake won't take over the world, nor should it. But certainly the option of a high-capacity dual-pivot sidepull has to be a good thing, and all fans of stopping their bikes should welcome it.

One bikesworth (front, rear). Set up with allen mounts, with nutted bolts included if you need that kind and are up to the task of changing. Kool Stop dual compound brake shoes standard. Grey housing, pro cables. Everything deluxe, except the plain box.

Silver Sidepulls: 15-026 \$85

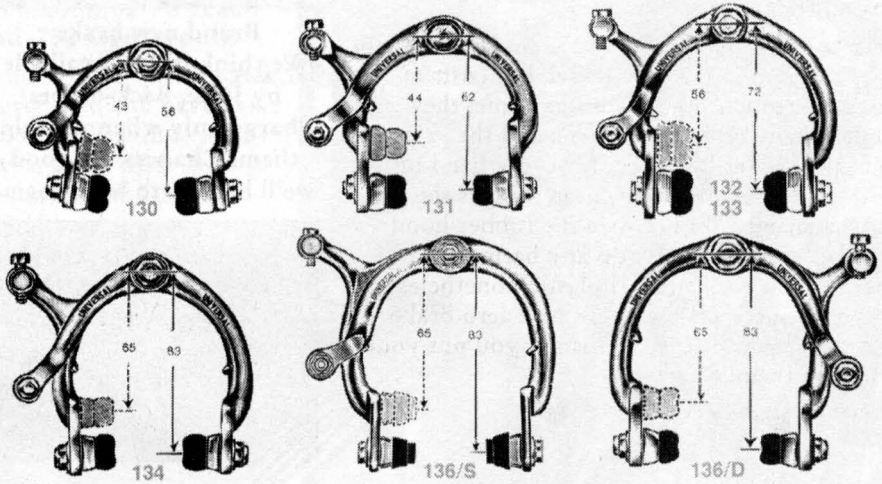

## Brake Reach Is Everything, Pal. *Everything.*

Well, okay, there's more to LIFE than brake reach, but brake reach is the single most influential factor in determining how useful a BIKE is—because it determines how fat a tire the bike can fit, and whether or not the bike can fit fenders. Those are important qualities if you want to ride beyond the smooth & dry.

The illustration above, from a 1960s brake manufacturer's catalogue, shows six sidepull brakes and their minimum and maximum reaches.

The fact that one brake maker made such a wide range of sidepulls says a lot about the times. Bike designers could look at the numbers and pick whichever model made the most sense for the tires and fenders the bike would use. Bicycle riders knew about brake reach, too, because manufacturers catalogues and retailers listed them and talked about them. Brake reach this, break reach that—oh, those glorious days! (only halfway joking here; the message is serious and real).

But sometime in the early '80s, consumer bikes started copying racer's bikes, and racers kept going to shorter and shorter reaches (as roads improved and the need for comfortable tires diminished). Today, brakes on the typical road-racing style bike have a reach of 44mm, which works fine for pro racers who ride only skinny tires, but makes no sense at all for a regular person. It's like driving a car you have to climb into, with a roll bar but no top; a tachometer, but no radio; bucket seats but no place to carry diddly.

No, brake reach isn't everything, but lack of enough of it can sure hobble an otherwise fine bicycle. If you're light and ride only on the road and don't use fenders, don't worry about brake reach. Otherwise, pal...worry!

### A Brake Reach Chart for Sidepull and Centerpull brakes

Brake Reach	Max tire/no fender	Max tire w/fender	Notes
44	28mm	22mm	racing only
47 to 49	35mm	25mm	max. for racing sidepulls
54 to 57	38mm	32mm	RBW's standard for road
63 to 65	40 to 42mm	40mm	best all-round road/trail
70 to 72	fits all	fits all	fits big tires but looks odd w/ small to med ones

This chart assumes that the brake hole is low in the fork crown...no more than 10mm above the bottom of it (never an issue in the rear). Most carbon forks have high holes and 44mm of reach, and severely limit your tire options.



## Shimano Tiagra

This lever has 90 percent of the looks and quality of the aero Dura-Ace model, but costs 60 percent as much. As aero levers come, they don't get any easier than these; and the grip size and shape is eerily perfect for every hand on earth. The only blatantly cheap thing is the plastic whatchamacallit between the rubber hood and the lever. It doesn't do any harm, and it doesn't look bad, but it is plastic nonetheless. Forget about it—if you want nice aero brake levers that you'll love the instant you put your hands on them, get these.

Shimano Tiagra Lever: 15-091 \$48

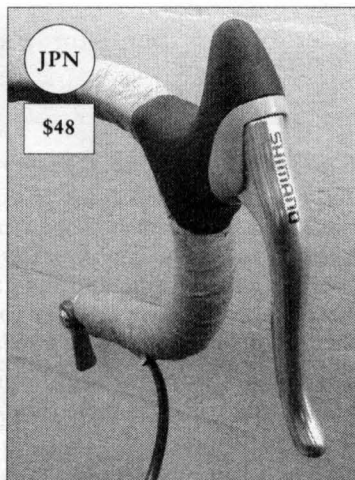

## Cane Creek Chubby (now in gummy, too)

These are wider across the lever body than Shimanos are (they're like Campy Ergo levers in that way), and many riders try them, get used to them, and then prefer them. If that were all they offered, we wouldn't offer them, but it's not. One really nice feature is a quick-release built into the lever body. This lets you open up the brake calipers more, to let out a fattish tire mounted on a skinnyish rim. It's not a make-or-break feature, but it's a thoughtful and convenient, if not convivial one. This lever is also available in a short-reach version for the wee folk.

Cane Creek Normal, black hood: 15-123 \$38

Cane Creek Compact, black hood: 15-122 \$38

Cane Creek Normal, gum hood: 15-129 \$38

Cane Creek Compact, gum hood: 15-128 \$38

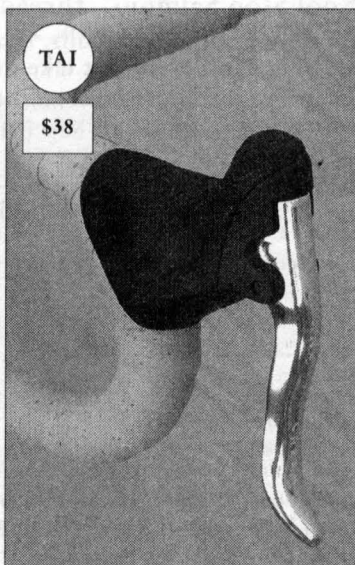

### Where to put them on the handlebar

The traditional "proper" position is with the bottom of the lever flush with the bottom of the bar. With the lever loose on the bar, you set the bar on a table, let the lever slide down until it hits the table, and tighten it there. There's no compelling functional reason to put the lever right there, so it stands to reason that this became "proper" only through use, and there can be little doubt that it got *that* way because it makes it easy to be consistent on an assembly line with scores/hundreds/millions of people mounting levers on handlebars.

But but BUT...there's a position that you may find more comfortable. Raise the bottom of the lever up off the table a thumb's width, about 12 to 16mm, and snug it there. This shortens the "ramp" of the bar behind the lever body, and gives you a flatter place to put your hands. If you raise the levers even more the effect will be greater, but that'll make it harder to reach the lever when you're down on the drops, so don't raise it too much. One last thing: Rotate your drop bars UP about 10-degrees. That helps, too.

## Don't throw out your new Shimano pads...

The Salmon pads below are better, but Shimano pads are still excellent.

### Kool Stop Salmon, post-style

They're close to the color of salmon flesh, and it's the best brake compound of all time. The shoes are curved to fit the rim, and the hardware makes it relatively easy to toe them in properly to avoid squeaks.

These shoes work for cantilever brakes that use post-style (non-threaded) shoes.

Post-style Salmons, per pair: 15-061 \$10

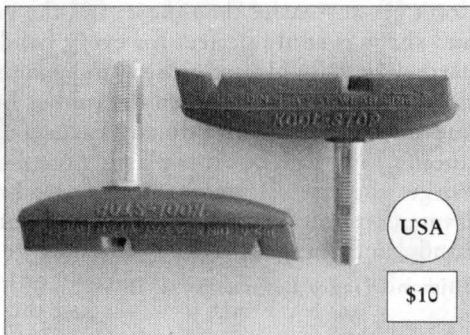

### Kool Stop Salmons, threaded style

As above, but for sidepulls, Dia-Compe center-pulls, or cantilevers that take threaded brakes.

These are the house favorite these days. They come with a spacer and convex & concave washers that allow you to toe them in easily and put them right where you want them. The iron-oxide based rubber (that's why they're red) grips well, doesn't fade, lasts a long time

Threaded Salmons, per pair: 15-119 \$11

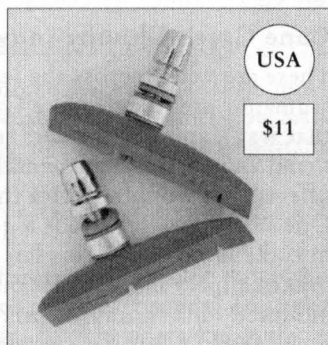

### \$12 pack of brake incidentals

**Brake housing.** Ours is grey, good and you get enough for a big bike with aero levers and split cable stops.

**Housingcaps.** These are usually chrome-plated brass. Why do that? We like the brass to show. Your bike will look like a fine old sailing ship in no time! Set of 6 (not 3, as shown).

**Brake cables.** Dual-ended. Cut off the end you don't need. Two.

Brake incidentals: 17-131, \$12

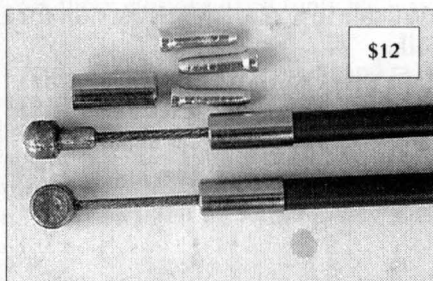

To cut the cable and housings, you still need cable cutters or dykes. If no gotten now, gettem at a bike shop or hardware store. Make sure you pay at least \$20, because if you don't, they're bound to be lousy. Get a fine file, too, to file smooth the end of the housing after you cut it. Hold the file still, rub the end of the housing briskly, like this:

### Stopping brake squeal before or after it happens

Squeal is just high-frequency vibration. You can stop squeals in most things with grease, but we're talking about brakes here, so grease is out. To prevent brake squeal, angle the forward (toward the front of the bike) edge of the brake shoes so they contact the rim before the back of the shoes do, by about 2mm. That way, the rim won't force that part of the shoe outward during braking. The vibration is alternate grabbing and slipping as the pads grip and slip on the rim.

If they still squeal, sand the brake shoes to get rid of sticky stuff that might make them too grabby. If that doesn't help, sand the rim for the same reason. The best way: Put some Scotchbrite between the pad and rim, then go down a steep hill with the brakes on. If that doesn't work, call Mark here, but don't tell him we suggested that. Ease into the question.

## Tektro Cyclo-X Levers

These are designed for cyclo-cross racers, and they work for everyday riding, too. Whether you want to complicate your handlebars is another matter... but the fact is, these are quite nifty. You still have your regular brake levers, and one set of cables, but both your normals

and these “interrupters” work the brakes. It’s hard to explain, but in real life it’s simple, so if you’re nervous, don’t be. This isn’t the dream set-up if you ride with a handlebar bag, but not all bikes wear bar bags, and if you’ve got one that doesn’t, and you ride it either in town or off-road a lot, and/or your handlebar is too low anyway, then these are just the ticket. A hinged clamp makes them go on easily, no need to untape the bars. Instructions included, too.

Tektro Cyclo-Cross Levers: 15-109 \$35

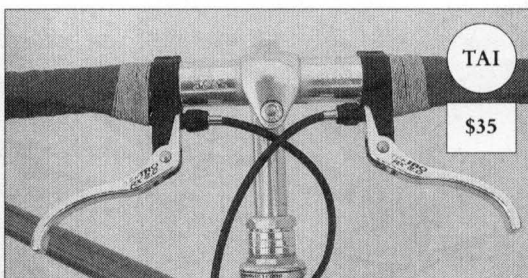

## Dia-Tech mtn lever

This is a basic, clean, simple, high quality, all-around mountain bike brake lever. It fits onto handlebars that are 22.2-inches in diameter, and among the bars in this catalogue, that means the Albatross bar.

It has settings for both V-brakes and non-V brakes—sidepulls, centerpulls, cantilevers. We have some as pictured, some all silver. Basically the same lever, same function, same quality, and the supply is spotty enough that we need to have a backup. So when you order one, we’ll send you what we have. They’re both excellent levers, and cosmetically fungible on any bike.

Dia-Tech mountain lever: 15-124 \$25

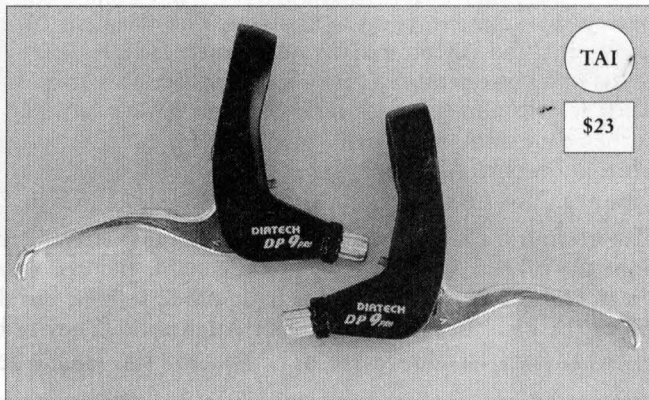

## Braking Notes & Tips

In the U.S. the law requires bike makers to hook up the left brake lever to the front brake, and the right to the rear. There’s no harm in that, but motorcycles have it reversed, so if you’re used to motorcycle braking, you might want to reverse your bicycle braking, too. Otherwise, just leave them as they come.

Panic braking causes more crashes than anything else does. Locking the front wheel almost always makes you crash. Many people know this and underbrake the front wheel, and that’s a mistake, too, because the front brake is the most powerful, the most effective stopper.

**When you brake, shove your bottom rearward**, and get low on the bike. The interruptor levers we sell are for scrubbing speed, not for panic stops. They’re convenient and good and powerful, but for important braking, it’s best to be lower, and with your hands further apart.

Set up your brakes so that you can’t squeeze the lever to the handlebar.

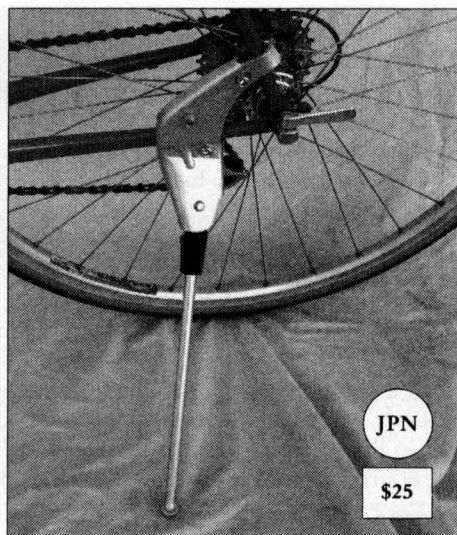
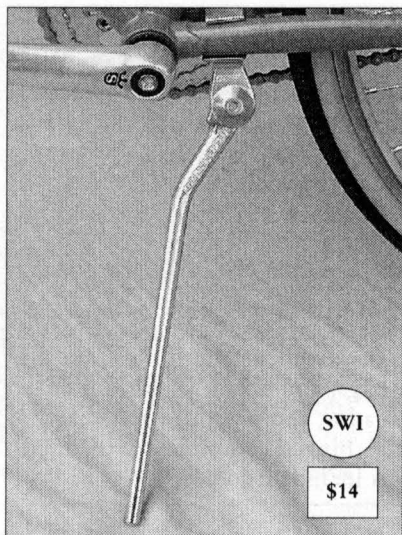

### A Swiss and a Japanese Kickstand

The Pletscher (Swiss) kickstand on the left has been around for 40+ years with no perceptible changes, because it works. The excellent American Greenfield is a copy of it, and there's basically not much difference, but we're stocking the Swiss one now, because (1) We find the idea of a Swiss kickstand irresistible; and (2) It weighs almost two ounces less and mounts with an allen bolt. This model is the center-mount (normal) one, and it mounts onto the chainstays behind the bottom bracket. Tip: Tape the tubes first, and don't play Charles Atlas when you clamp it. Not Lou Ferregno, either. Die-cast aluminum, 7.9oz.

The Minoura, a rear-mount kickstand, clamps onto the rear stays of most bikes. Tape the tubes first. This style is more stable but also less stealth-like. It works great, and is our first choice for light-tubed frames, but don't let that scare you off of the Pletscher (reread Charles Atlas note). They're both good.

Pletscher center-mount: 20-139, \$14    Minoura rear mount: 20-107, \$25

### Kickstands, far from being dumb or lousy, are good.

Most bike aficionados go their whole adult life kickstandless, and yet some people can't imagine a bike without one. A kickstand doesn't weigh that much—about 10oz. In the sane world, that's light.

It's easy enough to learn the tricks of secure bike leaning so you don't need a kickstand, but there are times when having one is a huge help. Loading a bike with camping gear is easier when the bike is partially supported by a kickstand. Parking the bike at rest stops on organized rides is another time, because often all the good spots are taken. For shopping, it's nice, if not essential, to not have to lean the bike against the store's window; and if you bring your bike into the office, a kickstand is the polite way to park it, too.

There are center-mount kickstands that clamp onto the chain stays behind the bottom bracket, and rear-mount kickstands that mount back by the rear dropouts, onto the seat stay and chain stay. They both have their pluses and minuses, but they both work fine. If no matter what, you refuse to use a kickstand but you still want a stable way to keep your bike upright, put a thick rubber band around the front wheel's valve stem, then around the down tube, then back onto the valve stem, hooking over it in the opposite direction from the first loop. This stabilizes the front wheel, which makes the bike less likely to roll and flop.

## Learn Your Pubic Bone Height (PBH)

It's not the inseam on your pants, it's the distance from the ground to your pubic bone, when you're in socks or bare feet. From this you can derive your best saddle height (within 5mm or so). PBH is a key measurement we use to design a frame. It's easy to measure, and if you're reading this catalogue, it's a good indication that you're deep enough into bikes that you ought to know yours. Here's how to do it.

### You will need:

- Two paint stirring sticks, rulers, or a thin hardcover book.
- A metal tape, and you might as well make it metric.
- An honest, helpful person with good vision.  
(Note: It is not necessary that this person be a friend.)
- Bare feet & a hard floor. Actually, socks are allowed, but no soft floor.

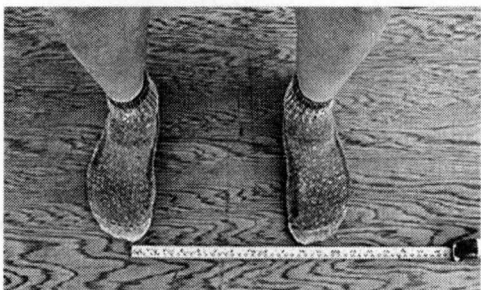

On the hard surface, stand with your feet about 10-inches apart. Plus or minus an inch.

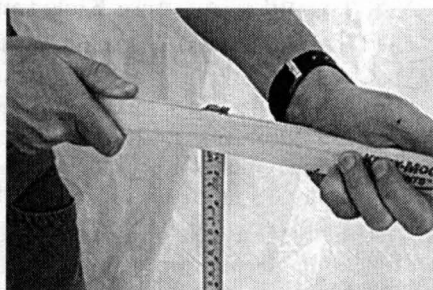

Sandwich the tape between the stirring sticks. Then call your helper, because from this point on, you can't do it accurately by yourself.



With one hand in front and one behind, pull up **HARD** on the sticks, past the soft tissue, until you hit bone. If you're chubby, you may not make it all the way to bone, but try.



Your helper should make sure the tape is straight. Once it is, that same person reads the tape on the hard surface. That's your PBH. As long as the tape is straight, you cannot overmeasure your PBH. If you do this procedure 10 times, the highest reading will be the most accurate.

### **Finding your Right Saddle Height (SH) from your Pubic Bone Height (PBH); and then once you've done that, figuring out your Right Fame Size.**

There are lots of ways and systems and approaches to figuring out the best size for you, and then setting it up (with stem height, extension, saddle height and fore-aft position, and so on). There's the LeMond Way, the Guimard Way, the Fit Kit Way, the Size Cycle Way, the Local Guru Way, the Ask a Fast Guy Way, the Chat Room Way, the Way You've Always Done It Way.

Certain funny bike styles may require a different way. But for normal bikes, the way we do it works well all the time, and it's simple, and you can do it with a friend using things you have laying around the house.

#### **SH = PBH minus 10 to 10.5cm**

But: Thick-soled shoes and Look pedals require a higher saddle.

What to look for when it's right: A slight bend in your knee when your pedal's at the bottom of the stroke and your foot is horizontal. No rocking side-to-side when you pedal.

## **Think about this when picking a frame size**

1. You should be able to straddle the top tube with an inch or so of clearance. For trail bikes, two inches is probably better. Tall people always get more clearance than short people; it's no better or worse, it's just a fact.
2. Get the biggest bike you can straddle with sufficient clearance. This suggestion will make modernists howl, but the higher your bar, the less stress on your back, neck, arms, and hands.
3. Flexible skinny riders can more comfortably ride lower bars than can heavy and stiff riders. But even skinny yoga masters do well with higher bars.
4. A bar with rise (like the Albatross), or a tall stem can compensate for a frame that's a bit small.
5. Here's a good rough guide to frame sizing that, if you must know the truth, is actually a lot better than "good" and far from "rough":

For riders over 6'3", PBH minus 27 to 29cm is a ballpark frame size.

For riders between 5'11" and 6'3", PBH minus 26 to 27cm.

Between 5'8" and 5'11", PBH minus 25 to 26cm.

Up to 5'8", PBH minus 24 to 25cm.

Know your PBH. It's not inseam, it's not somebody else's interpretation of leg length. It's how high your pubic bone is above the ground when you're in bare feet or sox, and your feet are ten inches apart. That's PBH. Use a metric, metal tape.

### **Handlebar Height for Different Terrain**

When you climb, the front end of your bike is elevated, so low bars feel higher. And, when you climb off the saddle, your reach to the bars is decreased. So for climbing hills, lower handlebars aren't so bad. BUT: For flat riding and descents, higher bars are much better. So what do you do if you ride up and down and level? Set up your bars for flat riding and descending. It'll still feel fine for most climbs, but on a super steep one when you're leaning way forward and barely turning over the pedals, the normal hands-on-hoods climbing position may put the bars too close to you. That's not a problem. Just climb on the drops.

## How fat of a tire should you ride, and as far as that goes, how hard should you pump them up?

Except for racing or pretending to, there's no fine reason to ride a tire less than 27mm. Ever, no matter what you weigh. Hundred-pounders shouldn't be riding around on 21mm tires just because they can. What are they gaining, except nothing?

A little more air volume allows a little lower tire pressure (PSI), which in turn means more comfort, more traction, and longer lasting wheels—a pretty good deal considering it costs you negative nothing. In the chart here, the listed width is actual width, regardless of what the tire says it is.

Rider Weight	Surface	Minimum tire width	Minimum PSI
Under 180lb.	Smooth	27mm	70
	Rough	32mm	60
	Dirt/trail	35mm	50
180 to 210	Smooth	27mm	85
	Rough	32-35mm	65
	Dirt/Trails	35mm+	50
215 to 250	Smooth	27mm	100
	Rough	35-37mm	70
	Dirt/Trails	37mm+	60

We have a more complicated tire-selection chart on our site: [rivbike.com](http://rivbike.com).

### Should you ride your tread down to the casing?

Only if the sidewalls are still in good shape, and they probably aren't if you've stored the bike outside. Watch your sidewalls at least as much as you watch your tread. A hole in the tread is unlikely to grow big and suddenly explode, because the rubber contains it, but a sidewall cut is in a much thinner part of the tire, and a little gouge gets big faster, and can lead to a sudden & explosive failure, and so on.

If you weigh under 150, you'll get at least 3000 miles on a Roll-y Pol-y, and at least 4200 from a Ruffy Tuffy. If you're around 210 pounds, you can expect 2500 from a RP and 3200 from an RT. The Paselas have even more tread, and I don't know if anybody has ever worn one down to the casing, but don't try. By the time the tread is that thin, the sidewalls will be too sun-baked and brittle. The Paselas are super durable, but it's not good to push any tire.

### How do you judge a tire's quality?

You can look at it on and off a rim. You can see if it mounts straight. You can scout out obvious flaws, and you can ride the heck out of it. But probably the best sign of quality, and one that's beyond the ability of any one rider, or even any pack of riders to evaluate, is consistency. Reject rate. How many tires out of a thousand are going to be either out of spec or have defects that weren't caught at the factory?

Almost all of the tires we sell are made in Japan by Panaracer. Panaracer is a small tire maker (by modern standards), and its tires are two to five times as expensive—for us to buy, that is—than competitive tires from Taiwan, Korea, Indonesia, China, and Vietnam. Some good tires are coming out of those countries and those factories, but in our experience, the Panaracer-made tires are the most consistent. We've seen two bad ones in ten years.

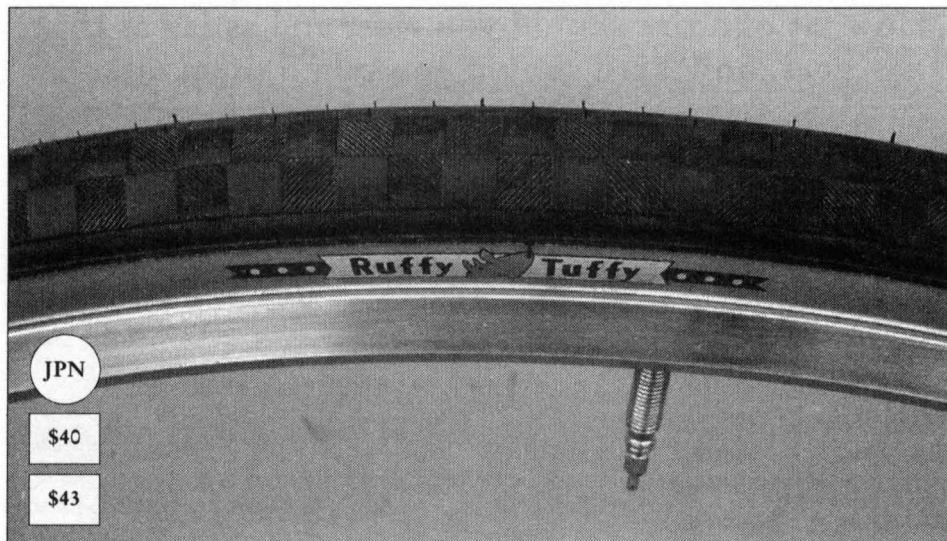

## For Road Riding The Roll-y Pol-y (RP) & the Ruffy Tuffy (RT)

These are the roundest, best-cornering, strongest, and safest lightweight road tires we've ridden. If you don't race, you don't need and arguably shouldn't be riding on anything lighter or skinnier than these. The two models are almost identical, and we'll tell you the differences at the end. Here's how they're alike and why they're so good:

1. Width: 27mm. That's skinny enough, and can be pumped up to 120 psi, but still has enough volume to be ridden at 80psi, for more comfort on bad roads. At 290g (Roll-y Pol-y) & 320g (Ruffy Tuffy), they're light enough for any non-racing use.
2. They're extra round, due in part to a special mold. Round tires corner better. They don't "dive" when you lean them over hard. These are the best cornering tires we've ridden, and it's safe to say that if you slide out when riding these, it ain't the tire's fault.
3. Their sidewalls are different enough in color from the black tread that you can look down from the handlebars and tell if your tire's going flat.
4. The tread is smart. It's black, because that's a good color for tires; and is checker-board, because we aren't sure whether slicks or treaded tires work best, so it has both. Basically, it functions like a slick, which is the way to go for road riding.
5. The sidewalls are super strong, for extra safety. The casing itself is nylon threads, as usual, but it is reinforced (invisibly, inside) with a super tough taffeta. That way, you're less likely to get a cut sidewall that could blow out suddenly and send you down.

The Ruffy-Tuffy and Roll-y Pol-y have every quality we like in a road tire. You won't find better made tires at any price.

The RP and RT are visually identical, but there are some differences:

1. The RP's tread is 1.5mm, which is normal for today's light tires. The RT's is 2.5mm, for even longer wear. A 200-pound rider typically gets 3,500 on a rear RT, and about 2,700 on a rear RP. That's long wear in both cases.
2. The RT has a kevlar belt beneath the tread, for extra puncture resistance.

Roll-y Pol-y (700x27): 10-034 \$40

Ruffy-Tuffy (700x27): 10-043 \$43



JPN

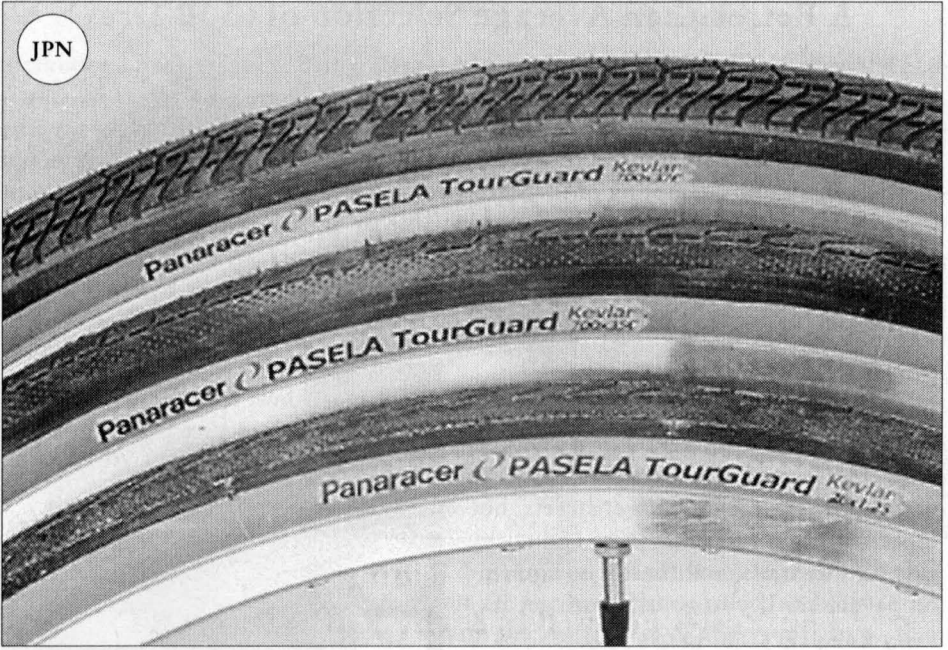

## Panaracer Pasela: When you need more volume for touring, lousy roads, and light trail riding.

The Pasela has evolved slowly over the past 7 or 8 years to its current state of perfection, and where before we just liked them a lot, now we actually love them. They are consistently round, the tread never wears out, they're light for their volume, they ride great on all surfaces, and in seven years and several thousand tires, we've seen just one defect.

Nashbar and those guys sell Pasesas also, but ours are the folding models with kevlar belts, for lighter weight and extra puncture resistance. We carry a range of sizes, and there's a chart a page or two back to guide you to the right one. If you have a typical short reach modern carbon frame or fork, you probably can't fit any of these tires. That's too bad. Next time, seriously, make sure you get a frame that has more clearance. In the chart below, Ø is diameter, and widths are listed in millimeters, mounted on a 22mm wide rim and inflated to recommended max.

Size	Part no.	Price	Ø	Width	Size	Part no.	Price	Ø	Width
700x32	10-072	\$30	690	31.5	26x1.25	10-083	\$30	690	31.5
700x35	10-071	\$30	696	34.5	26x1.5	10-070	\$30	696	34.5
700x37	10-075	\$30	700	37	26x1.75	10-074	\$30	700	37

## Inner Tubes

The superlight 700c fits to 700x28; the 700 Normal, to 700x40; the 26x1, to about 26x1.25; the 26 medium, to 1.75; the fatty, to 2.3. They stretch!

### Weights & Part Numbers

700 Superlight	67g	10-004	\$6
700 Normal	120g	10-001	\$4
26 Skinny	119g	10-005	\$6
26 Medium	133g	10-002	\$7
26 Fat	200g	10-007	\$7
650B (all)	125g	10-066	\$7

## A Better than Average Selection of 650B Tires

650B wheels have a bead seat diameter of 584mm, which is bigger than a mountain bike tire (559mm), and smaller than a 700c road tire (622mm). Last year we introduced the Saluki, a bike made for this wheel size, and that obligated us to support it, which we'll do from now on forever. Our selection is by no means complete, but it represents a good sampling of the sizes you're likely looking for, and it will continue to grow as other models become available or we have them made for us. In the coming years we expect more models to become available, as more 650B bikes are made. It's still not in the top three choices for round-the-globe touring, but it's harder and harder to reject this size based on scarcity, because it's no longer scarce.

### Fatty Rumpkin 584x41

Designed here specifically for roads and dirt trails that require extra grip and volume. The Rumpkin's round cavities make quite the racket on wet streets, but more importantly, it's a secure and cushy ride on dirt trails, and there's no squirm on pavement. If you go off-road, get it.

Fatty Rumpkin 650B: 10-086 \$42

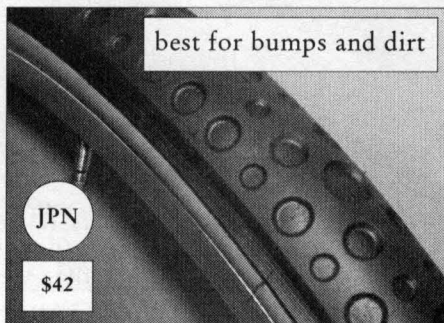

### Panaracer C de la V 584x36

A lightish, puffy, skinwall tire that measures 38mm wide and weighs 430g. It grips well, rolls smooth and fast, and with a psi rating of 50, it's like riding on fast marshmallows. A wonderful tire in every way. We're lucky they make it.

Panaracer 650B: 10-063 \$28

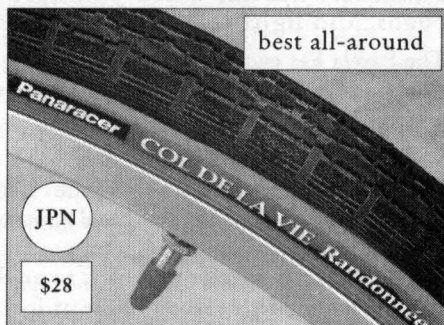

### Nifty Swiftly 584x33 w/Rainbow

Basically, a chubby 650B Ruffy-Tuffy, with reinforced sidewall for safety, 2.5mm tread for long wear, and kevlar belt for puncture resistance. One sidewall has a rainbow SpeedBlend, the other is tan. Wire bead, about 400g, rideable from 50 to 75 psi. Comfortable, swift, and nifty. It costs us more than the Maxy Fasty, but I/Grant want to get SpeedBlend tires out into the world, so we sell this way too cheaply.

Nifty Swiftly 650B: 10-082 \$40

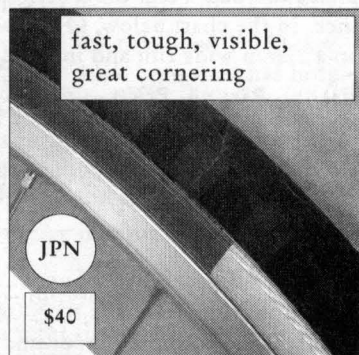

### Maxy Fasty 584x33

This is a Nifty Swiftly minus the extra tread, kevlar belt, wire bead, and SpeedBlend sidewall. Less all that stuff, it's a lighter, presumably faster tire, and is the top choice for speedy riders and decent roads free of glass and goatheads. It weights just 315g. A great riding tire.

Maxy Fasty 650B: 10-087 \$42

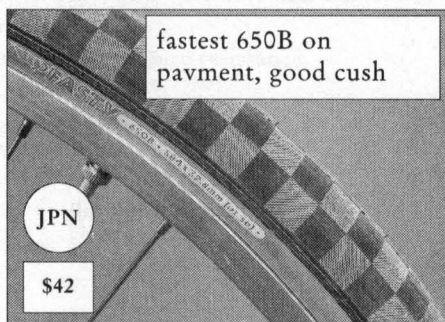

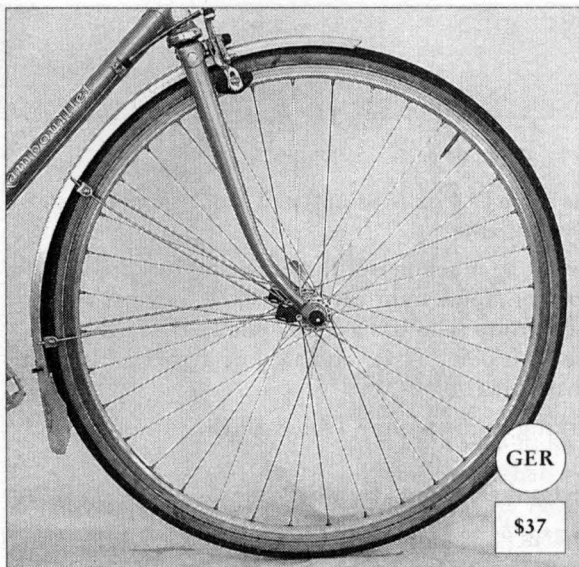

## SKS Fenders

America is the only country in the world where 90 percent of all cyclers don't use fenders in the rain. But one ride with fenders will convince you to never ride in the rain without them.

These are our favorite fenders. They're recycled German plastic and have top-notch stainless steel hardware. We've tried many others, and continue to do so, and always come back to these. They aren't perfect. Honjo fenders are longer and cover more, but they cost \$100+ and are more difficult to

mount. Zefal fenders are longer, too, but are harder to mount also, and less secure when mounted. SKS fenders are on the short side, so add mudflaps to the back of each fender. The easy way is with duct tape, but if that offends you, make them from cut up water bottles, tongues from old desert boots, or use our Nigel Smythe mudflaps. It's a mudflap-option world out there!

Four sizes fit 26-inch and 700c wheels, fat and skinny.

For 26-inch tires up to 1.5: 27-002 \$37

For 26-inch tires up to 2.0: 27-003 \$37

For 700c tires up to 700x32: 27-004 \$37

For 700c tires up to 700x40, and 650B: 27-005 \$37

Fender stays and all hardware, but no dang fenders: 27-007 \$15

## Spoke Reflector (one)

Regular plastic spoke reflectors are fine, but everybody takes them off bikes because they're rigid plastic, heavier than necessary, and make it harder to true a wheel. Not so with these! I/Grant have used these for more than 21 years. They weigh 11g and mount in two seconds.

Spoke Reflector: 31-371 \$5

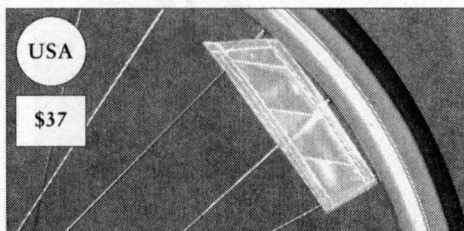

This tire is rolling to the right. Mount short edge toward tire, folded in front.



## Ankle Band (one)

This is the best ankle band out there. It's our own design, and one I/Grant have used for 14 years. It closes up the pants, and places a big reflective strip out towards traffic, where motorists can see you. Easy on and off. Sewn for us in San Francisco, by Mary. White or yellow Reflexite. No color choice, they're both bright.

Ankle Reflector: 31-370 \$5

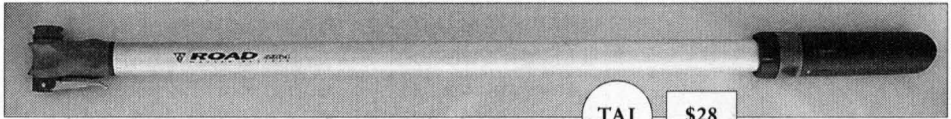

TAI

\$28

### Topeak MasterBlaster.

Our pump du jour. It weighs the same (9.4 oz Medium) as a Zefal, works as well, looks better, and is more readily available.

Frame pumps are good. They work so much better than mini-pumps do, and when you get a flat, that's important. Some mini-carriers, when they get a flat, look around for somebody in the group who has a frame pump. It's in the group's best interest to supply one, it being faster and all, but there's a little bit of funny monkey business in that scenario.

Want a nice-looking, great working frame pump? This is all that. Presta and Schrader, it works both.

Sizing: Measure the gaps between tubes, and go by this:

M fits gaps 49 to 54cm gaps; L fits gaps 54 to 59cm gaps; XL fits 59 to 64cm gaps

M: 28-024 L: 28-025 XL: 28-026 \$27

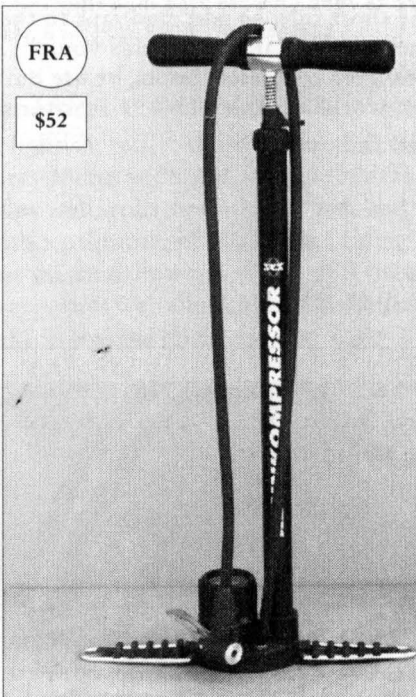

FRA

\$52

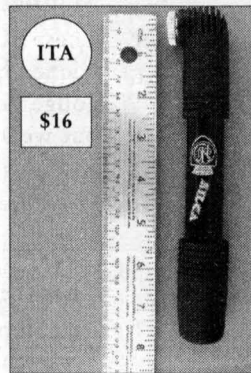

ITA

\$16

### Silca Mini

The best mini we've tried, and we tried many. Some are even smaller and lighter, more clever, or more powerful, but there's always something about them that kills the deal—

hard to grab, or the plunger handle hits your other hand, or the stroke is too short. This Silca wins because it telescopes, so you get a much longer stroke; and it's easy to hold; and when you pump with your right hand, you don't pinch your left hand. The head converts from Schrader to Presta.

Silca Mini: 28-023 \$16

### SKS Renkompessor

The floor pump market these days is going nuts, and there are many good ones. We've used a few of them, and this is the one we end up using every day, a lot, in our shop. In any month, we pump more tires with it than you will in five years. There are more clever pumps out there, but none is more reliable; and it's still made in France. Our website has spare parts for it, if you need them. The gaskets are theoretically possible to install, but a real bear. The separate head & hose is the way to go if you don't respond well to frustration and/or are not super persistent and with lots of time on your hands.

SKS Pump: 28-015 \$52 Separate Head: 28-020 \$13 Xtra Gasket: 28-022 \$1

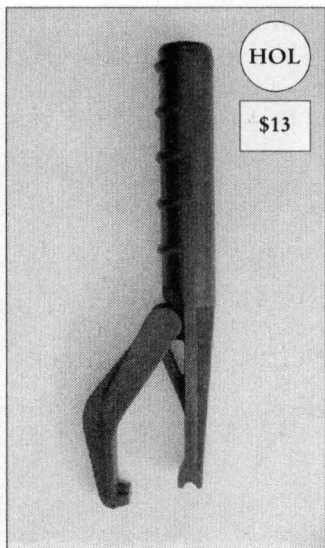

HOL

\$13

### Vermeer's Tire Lever

This isn't the tool you take with you on a day ride, although at 3.5oz it's not that heavy; and if you have weak hands, it'll be worth it. But mostly we sell it as the tool you use to install a difficult tire when you're out in your backyard. It out-and-out out-performs any tire lever we've used, and it's safe to say that if you can't pull a tire onto the rim with this baby, you're not following the simple instructions. It's made in Holland (Vermeer, Van Gogh, woodshoes, windmills, Dutch girls, and so on), and is the only lever we'd trust on a cold day with a new Schwalbe tire. It doesn't have a lever part built into it, so it's no good for taking the tire off the rim. When you need it, nothing else comes close. Made by Noswis or Simson.

Vermeer's Tire Lever: 19-077 \$13

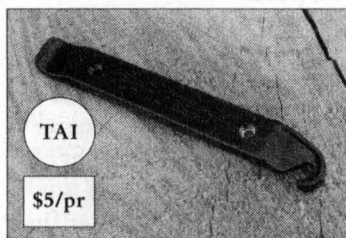

TAI

\$5/pr

### Magnetic tire levers that won't break

These SOMA brand levers have *steel cores* sandwiched between plastic, so they won't break or gouge your rims. Usually you don't need steel, but we've bent aluminum and broken plastics, and now that can't happen ever again forever.

Steel core levers: 19-075 \$5/pr

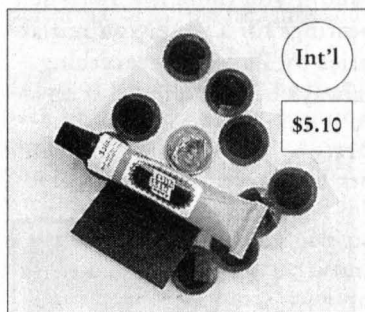

Int'l

\$5.10

### Einstein's Patch Kit

Small patches are the only way to go, and these Frenchies by Velox are the best. You get 10, a tube of European glue, a single glueless patch, a small square of sandpaper, and a ten-cent piece.

Albert's Patch Kit: 10-048 \$5.10

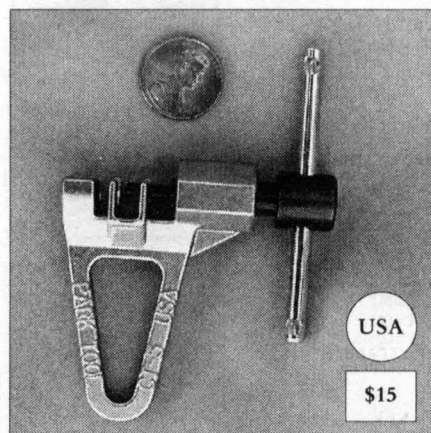

USA

\$15

### The Classic American Chain Tool

Good luck if you break a chain and don't have a chain tool. Also, can you imagine the satisfaction of helping somebody with a broken chain? This one works well.

Made by Park, in the land that brought you Russell shoes, Bob Dylan, Hiawatha, and 10,000 lakes.

Park Mini Chain Tool: 19-076 \$15

(penny shown for scale, not included)

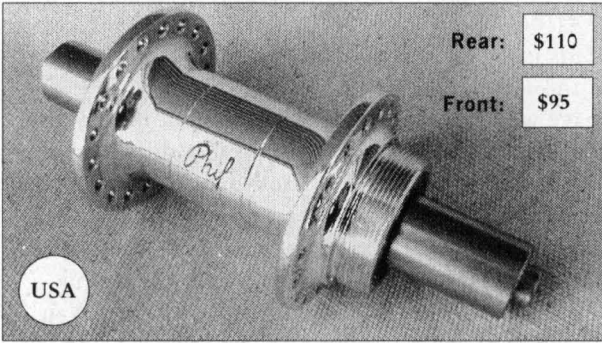

### Phil Hubs

If you still ride freewheels, hang in there with arguably the best threaded rear hub ever made. The body is machined aluminum, and the axles are made of super strong 17-4 stainless steel. You won't bend or break axles. You can change spacing with new endcaps. You can replace the bearings in five minutes. Phil hubs last a lifetime, and so are always a bargain.

#### Rear:

130x32°x7sp: 18-035 135x32°x7sp: 18-036

130x36°x7sp: 18-037 135x36°x7sp: 18-038

#### Front:

32°: 18-033

36°: 18-034

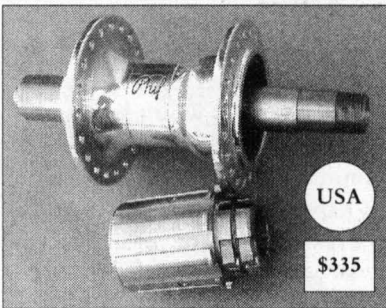

### Phil Cassette 8/9 Speed

If you must have the best and the price won't cause a spat that could lead to a separation, this is the cassette for you. How is it better than all others? Well, it has a larger diameter axle, which has to be stronger. It has eight pawls, which is absolutely stronger, and it is made to closer tolerances and has a better finish, which costs more. And four Swiss cartridge bearings, and if you think the Swiss sell their cartridge bearings for a song, you're flat-

out wrong. They're not like that. It's made in America by Phil, and everything Phil makes is the best of what it is. Plus, Phil will always be around, and if anything ever happens to this and it needs service, they'll do it cheap.

130x36: 18-142 135x36: 18-143 \$335 (also available in 32H—please call)

### We have more Hubs than This; and Can Build You Fine Wheels, too.

We have a good variety of Shimano hubs and all of the Phil hubs, front and rear, cassette and freewheel.

Rich Lesnik, who works here and has his own business (Hands On Wheels) builds strong, reliable wheels that all of us here ride. He has built all of our wheels for the past three years, and if your goal is trouble-free wheels that you never have to think about, have Rich get his hands on your wheels. DT spokes, brass nipples, no nonsense, even if you ask for it. He'll overrule you! He is just that kind of guy.



### Save Your Neck!

Don't ride any wheel, especially a front one, unless the quick release is properly closed. If you don't know how, find out. We can send you instructions, free of charge. Request by fax (925) 933-7305 and include your address. Or request it on your order.



## Combining Bikes and Chow

The best thing about putting a bag onto your bike is the food you can put into it that you wouldn't carry otherwise. Now, carrying food is not a concern on a quick one-hour ride squeezed in between Other Obligations, but on a social ride that goes beyond about three hours, good chow is a fine friend.

I think I know what you might be thinking—that one of the reasons you ride is to burn off fat so you can show off your Jean-Paul Gaultier wardrobe to best advantage; but I'm not advocating eating extra food. Just skip the breakfast and eat your first meal of the day well into your ride. Rather than eating at the table while reading the comics or war news, delay the pleasure and find some nice spot along the way, and eat there.

Riding is the only exercise that burns lots of calories and lends itself to eating them back on again. Too bad about that, but don't throw up your hands (or your food). A typical energy bar is 250 calories, and many riders go out with a couple of them. If you're going to eat 250 to 500 calories on a ride, you might as well make them sandwich calories.

A good cycling sandwich is on toast. Toasted bread is crunchier and it makes the sandwich last longer without getting mushy. After toasting the bread and making the sandwich, let it air out some, because if you put a hot piece of toast into a ziploc bag, it'll just reabsorb the moisture it's giving off.

Since you're carrying food, you can get creative. If you like sauerkraut on your sandwiches (with turkey and Swiss cheese or whatever), keep that in a ziploc until you need it, otherwise it might make your sandwich wet. Toast handles extra moisture better than non-toast does.

Nice sandwiches with tea or soup make any ride more special. It's sort of like slow food, bike-style, and once you work out the bugs and find yourself a supportive companion, somebody who looks forward to the meals rather than regarding them as an intrusion, then everything starts to get better.

Bags also let you carry tea-making or soup-cooking gear. On the next page we have a selection that's evolved over the past several years, and includes our personal favorite equipment for this. It's light, extremely well made and reliable, and packs easily.

—Grant

**We have a really good, really small selection of really good bike camping gear online at [rivbike.com](http://rivbike.com).**



### **Fifty buck titanium pot, 8.6oz titanium (Snow Peak)**

It holds 2 quarts, enough for 2-3 people, but at only 8.6oz, it's not too heavy for one famished male. It's not too deep, so food heats fast and evenly. The handle swings out away from the flame, so you don't grab a hot handle. It has a titanium lid and a tight-sealing plastic lid for keeping food warm if you can't finish it all right then and there. If you're more of a nibbler than an inhaler, that might come in handy. Anyway, it's as nice a pot as it ought to be for \$50.

Fifty buck Ti pot: 52-038 \$50

### **Thirty buck titanium mug, 4.8oz titanium (Snow Peak)**

It's a manly mug, with a removable lid so you can use it as a cookpot, or to drain noodles, or to keep hot food hot while you're off on another manly duty. The metal stays coolish so you won't burn your lips on hot metal, and if you grab the chamber rather than the handle, you'll be able to hold it. It has measuring increments on the inside, for precision cooking; and it holds a manly 24oz while weighing a ladylike 4.8 with the lid, 3.3 without. It feels good and looks nice. The handle collapses for packing it away. Manly, manly, manly.

Thirty buck Ti mug: 52-016 \$30

### **Twelve buck titanium bowl, 1.6oz (Snow Peak)**

Regardless of your tax bracket, you can afford this. It's a nice, deep, stable-based, featherweight titanium soup, cereal, or candy bowl, and it weighs just 1.6oz (45g). For packing, put the Trangia stove in it, put them both in the \$50 bowl, and let the cup manage for itself. Layer in a cotton bandanna or something to stop the rattle, just as though you were packing Fine China. If you have lots of these bowls, nest them all together, and the whole lot is light and compact.

Twelve buck Ti bowl: 52-018 \$12

### **Three buck stainless steel folding ladle, 2oz (Snow Peak)**

If you eat soup, we don't have to tell you about ladles. Soup and ladles go way back. If you know how good Japanese stuff is and how expensive it is, you'll be delighted and suspicious at how they can make this so it retails for only \$3. Maybe you don't want to know. It costs us just under \$2, which is even more amazing, and we definitely don't want to know how that happens. A Japanese stainless steel ladle for only \$3? It folds to palm-size in one second.

Three buck folding stainless steel ladle: 52-017 \$3



## Two Y-Wrenches

The Hozan has 8-9-10mm sockets, and is always the first choice for cantilever brakes and fenders, although you'll find other uses for it, too. The Park is the killer tool for 99.999 percent of the allen fittings on your bike, and we prefer it to simple L-shaped allens. Every bike assembly we do uses one of these. Get it!

Hozan 8-9-10 socket Y-Wrench: 19-023 \$13

Park 4-5-6 allen Y-Wrench: 19-068 \$9

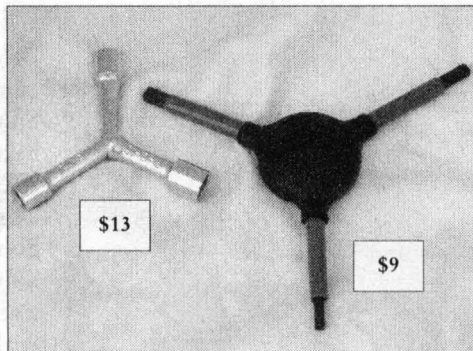

## Puller & Bolt Wrench

Despite what the photo shows, the bolt wrench fits 14mm crank bolts or 8mm allen bolts, and has a deep socket that won't slip off.

The puller extracts virtually all cranks. If you have a freaky one, you probably know it by now; otherwise, this is the tool. Made in the USA by Park. We use these tools every day.

Crank Puller: 19-060 \$18

14mm Bolt Wrench: 19-061 \$12

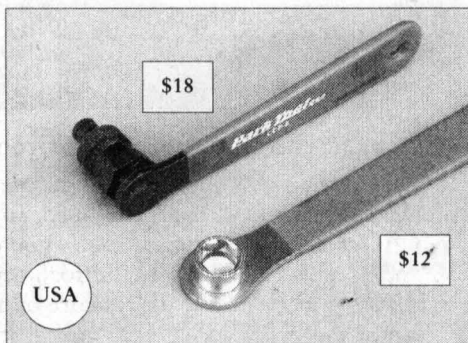

## Eldi No. 61 Pedal Wrench

The best we've ever used, and a true classic. It's long, so you get tons of leverage. So much, in fact, that we recommend holding it amidstrips for installations, and at the end for removals. Hard, chrome-vanadium steel. German. Tough. There's a 15mm and a 9/16-inch end, and good pedals take the 15.

Eldi No. 61: 19-051 \$15

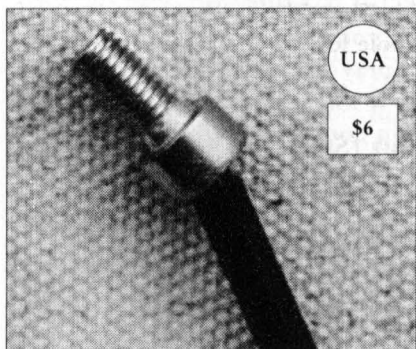

## 4mm Bondhus

This is a sanity saver. As you can see, it lets you attack the bolt from an angle, which is sometimes the only way to do it. Some bottle bolts have 3mm heads. There's no good reason. Replace them with 4mm bolts and use this. It is worth the \$6 on the installation of two water bottle cages alone. (Assuming your water bottle bolts are the practical 4mm size.)

4mm Bondhus: 19-011 \$6

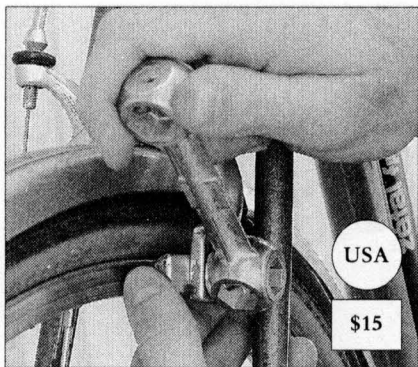

### British Dumbbell

Before allen fittings, this 6mm through 15mm spanner fit most of the bolts on a bike. No more, but we decided to stock it because it's made in England by the original maker; and it's cheap. You'll find the 14mm or 15mm good for fixed-gear axle bolts. The 8mm is good for brake pinch bolts that aren't allen. It's a nice shape and size. If you've got an older bike or a bike with a rear track/fixed gear hub, it'll be as useful as it is cute.

Original Dumbbell: 19-063 \$15



### Lip Ivo, the World's First Lip Balm

This is yet another one of those things that seem like one of a zillion other things of its type (in this case, lip balms), but is, in fact, the best kept secret/world's best of its type (in this case, lip balms). A crazy lady from Ohio who didn't even ride a

bike found out we had it and ordered a dozen, because her local source stopped carrying it. Pleasant peppermint-vanilla smell, but the main thing, and it's a big thing, is: It's the perfect waxiness, and stays on your lips, no drift into mouth. Made since 1903. It is, in fact, the world's first lip balm. Commercially marketed as such, that is. Lip Ivo: 31-242 \$1

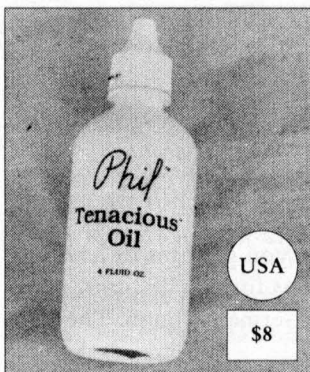

### Phil Tenacious Oil

Some places are just too hard to reach with grease (like the threads on brake pinch bolts), and regular oil is too drippy. This is perfect. It is tenacious, and as thick as cold syrup, almost a substitute for grease sometimes. We go though a bottle a year; yours will likely last you five years. Keep some around!

Phil Oil: 31-013 \$8

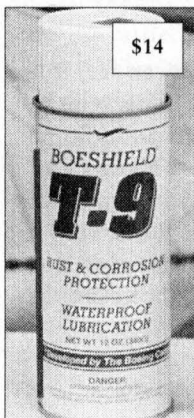

### Boeshield T9 Metal Protector & Lube

If you have metal around and you want to protect it from the elements and rust, this is it. Spray the insides of the tubes on steel frames to stop rust. Use it where you might otherwise use WD-40 to stop squeaks in door hinges. It's also a super chain lube—our No. 1 until this ProLube stuff (listed elsewhere) came along. Developed by Boeing to protect airplanes. It dries waxy, and works great. A 12-ounce can, which is what this one here is, rustproofs seven frames and lubes a dozen chains. Nobody here would want to be without it.

Boeshield T9: 13-034 \$14

## La Nolin

It's the oil in sheep's wool, and it works great for metal-to-metal contacts and threads. Prep for pressing in headsets. Steerer threads. BB shells. I smeared a raw lug with a thin layer of this and set it outside for 2 years, and the water didn't wash it off. Smells great. The tube makes it easy to use. The 2oz tube will last a year, easy, and probably four times that long.

Lanolin: 31-343 \$6



## Pine Tar Soap

This is our most popular item, and almost all who use it have sworn off other soaps except as a last resort. Oddly enough, women tend to hate it. It has a strong piney scent that reminds you (and them) of the woods and maybe that gives them the creeps. But it cuts through armpit stench like no other soap, rinses clean, is a fantastic shampoo (no more plastic bottles, herbal essence, and faux French names). Try it once and you'll be back. We sell the biggest size, a full 4.25oz, which is larger than the size you usually see in natural food stores.

Pine Tar Soap: 25-001 \$4

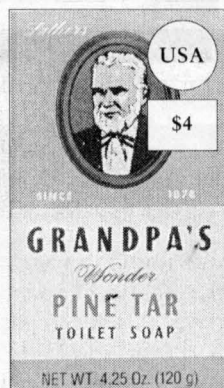

## Phil Hand Cleaner

We like the idea of citrus-based cleaners, but this one, made from wood pulp, works faster and better, and rinses off a lot more easily, too. Faster: About three times as fast. Better: It's slightly abrasive, and gets out the grit in the creases and under your nails. It has no smell. It's a Perfect Product.

Phil Gritty Brown: 31-038 \$8

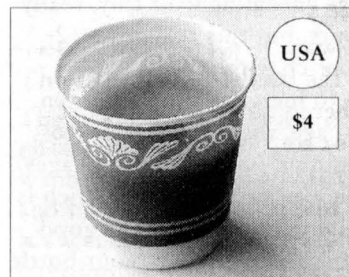

## Beeswax

It's good on all threaded things you don't want coming loose: Pedal dust caps, crank bolts and dust caps, headset locknuts, chaining bolts. Keeps shoelaces from untying themselves, too. Put it on nails and screws, to make them penetrate wood more easily. The first item we ever sold, on January 5, 1995, was a dixie cup of beeswax, so we're keeping it around forever.

Beeswax: 31-002 \$4

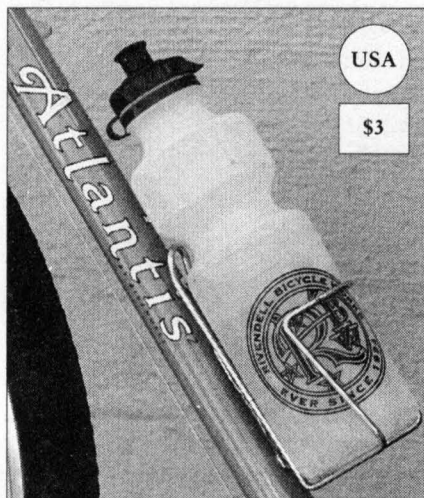

### Water Bottle

We don't live or die by the sales of promotional water bottles, and we've always sold them cheap. Well, now they're even cheaper. When an inexpensive plastic thing has your logo on it, that seems fitting. The only reason we don't sell them even cheaper is that they take up tons of space in our cramped warehouse, and that costs.

These are made by Specialized, and are the best we've used. The wide mouth accepts ice cubes, the top doesn't leak, and they're made of LDPE-4, which is one of the least cancer-causing plastics out there. Clear only, holds 28 oz, and usually with clear top & blue printing.

Water Bottle: 29-010 \$3

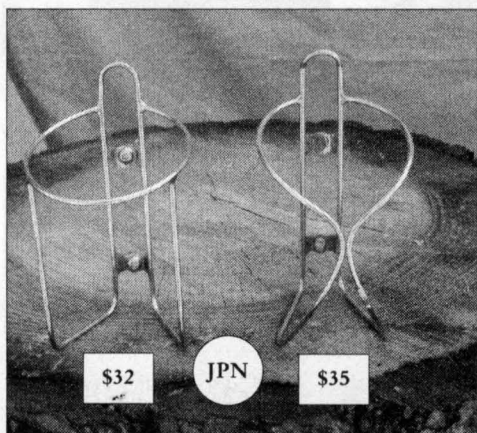

### Nitto Stainless Bottle Cages

Bottle cages have come a long way, and these are the ones that lead that way. They've since been mimicked and outright copied by fine firms who get them made in China, where labor is cheap, and if you decide based on weight and price, that's where you'll go. But if you knew Nitto like we do, or have experience with the quality of a Nitto anything, and the admittedly high price won't break you, then get the best and prettiest. The touring cage is better for off-road use.

Nitto Touring Cage: 29-012 \$30

Nitto Original Cage: 20-030 \$35

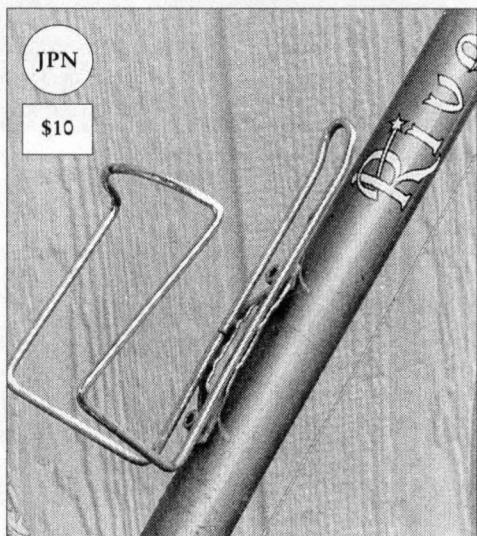

### ALE Steel Cage

This is the best value in a bottle cage. Since it's steel, it plain won't blacken your bottle. Compared to Nitto, it's a little crude, and yours may have chroming over tiny, really micro burs, but this remains a 12-star, super champion value, and heavens to mergatroid, at only ten bucks a cage, there's no reason to use aluminum or carbon fiber cages. This one weighs about 95g, which is plenty light enough. It looks good on any bike, and it holds your bottle securely over the worst roads. The slight amount of rust it'll acquire over the years just makes it look better. Really!

Ale Steel Cage: 29-001 \$10

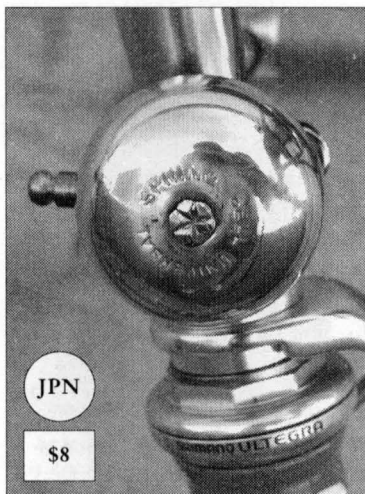

### Japanese Brass Bell

Solid brass, made to last a lifetime and then pass on to a Lucky Heir. Brass has the best ring of any material. It's rich and mellow, not the irritating high-pitched tinny ring we've all grown accustomed to over the millennia.

The bell has a coil-spring striker, and it's easy. You just flick it out and it springs back and hits the bell part—you'll be an expert on your third try! Sometimes, on rough roads, it rings itself. If that bothers you, you can space the striker out more. We've found that it keeps the bears away.

This bell rings for 5.5 seconds!

Coil Spring Brass Bell: 31-367 \$8

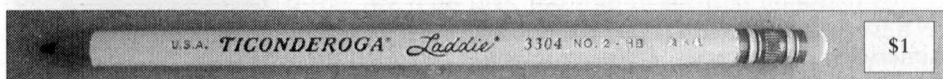

### Ticonderoga Laddie—Two for a Dollar!

Made for third-graders. It's fatter than most pencils, easier for uncoordinated hands but fine for coordinated ones, too. The lead is thicker, almost never needs sharpening, and NEVER breaks. Writes well on paper, cardboard, almost anything. Hard to find, but we got 'em. Good price. Doesn't fit most pencil sharpeners, but you can sharpen them with a knife, a two-hole sharpener (stationery stores) or the famous Boston Ranger 55. We couldn't live without them.

Two Laddies: 31-372 \$1

### Bicycle: The History

If you have even the slightest notion that this is a boring compilation of historical facts about a toy we all know and love, you've never been more wrong about anything in your life. It's like reading the morning paper the day after the events happened, and it makes sense of everything. David Herlihy is far and away today's foremost authority on the subject and a great writer. If you like bikes & history, get it. If you like us, get it here, not at Amazon. Or, if you get it at Amazon, spend the difference here.

Bicycle: The History: 23-038 \$40

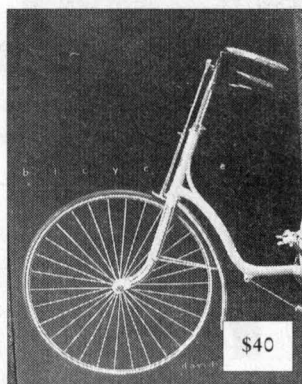

### The Dancing Chain

The culmination of Frank Berto's near-lifelong obsession with gears, and it's fair to say that if you want to know anything about the development and history of the derailleur, it's in this book and it's accurate. I think Derailleur: The History might have been a better title, but the book is hardly hurt by that, and if you're a seeker of information and a student of bicycle history, it's a must-read.

The Dancing Chain: 23-013 \$60

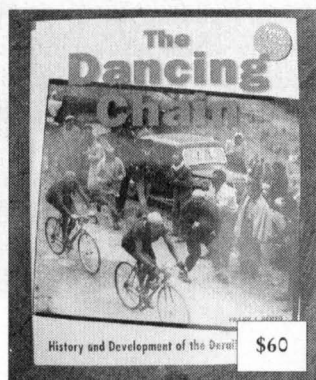

## The Song of Hiawatha

It's a book-length poem that reads like a novel and tells the story of Hiawatha, an Indian. Written in 1851 by Henry Wadsworth Longfellow, who was chastised for writing a sympathetic story about Indians. It's written in an 8-syllable per line beat. The language is lovely, almost magical, and if that's not enough, it is illustrated by Frederick Remington. Published by David Godine, with first-class details from type to bindery. It's not a bookshelf book. If you start it, it will pull you through. If you buy this and read a chapter and don't finish it, you may return it for double your money back in credit.

Hardback: 23-034 \$23 Paperback: 23-035 \$14

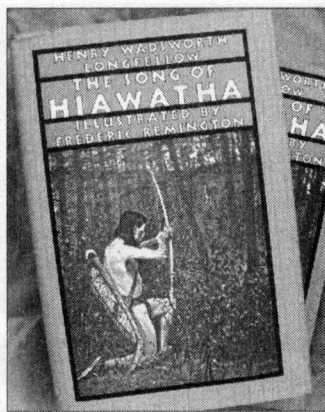

\$23

\$14

## The Book of Nonsense

Edward Lear's great work, first published in 1848. Limericks, short stories, a botany lesson, and a dictionary all written in Lear's uniquely weird way. It appeals to children and adults, it is a true classic, and ever since we've offered it, we've had a double-your-money-back guarantee on this. Out of more than 500 sold, only three people have taken us up on it. A beautifully bound-in-cloth edition that belongs in every home.

Book of Nonsense: 23-004 \$14

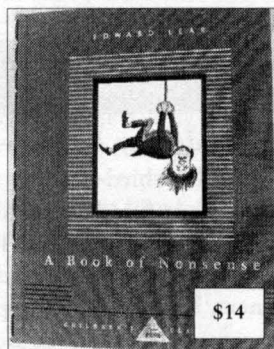

\$14



\$60

## The Golden Age of the Handbuilt Bicycle

This is a coffee table book with knock-your-head-off color photos of the most stunning collection of old French bikes you're ever going to see. It is in its final printing, we hear, and so if you'd planned to get one ever, you shouldn't wait too long. Written by resolute Francophile Jan Heine, with knock-'em-dead photos by genuine Frenchman Jean-Pierre Praderes.

This is the last printing, with no plans to reprint again. We will offer this book through July only.

The Golden Age of the Handbuilt Bicycle: 23-039 \$60

## The Bicycle Wheel

Wheel building theory and practice, along with a bicycle wheel appreciation course, this book is widely and rightly regarded as the definitive text on the bicycle wheel. Written by Jobst Brandt, it is clear, well-illustrated, easy to follow, opinionated, and informative. A great book for non-wheel builders as well, since it contains tons of good and useful information.

The Bicycle Wheel: 23-008 \$25

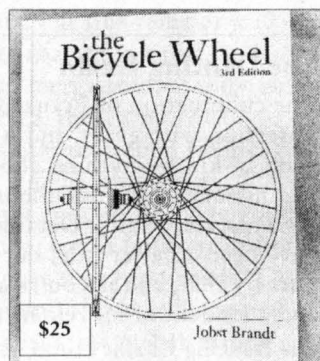

\$25

Jobst Brandt

## The Epidemic

(oddy enough, our top-seller)

This book's subtitle—*The rot of American culture, absentee and permissive parenting, and the resulting plague of joyless, selfish children*—is a downer that suggests the book was written by a tough love fan who believes sparing the rod spoils the child. Wrong! Author Robert Shaw is a family therapist in Berkeley and has a breadth of experience that qualifies him to write a book about how to raise happy children that contribute to society and make it a better world out there. It's the best nuts-and-bolts parenting book you'll ever read.

The cover price is \$14.95, and they cost us about \$9.50 with freight. But I want to sell tons of them this year, because it's so important. So your price is \$11, and if you want it free, we'll do that, too—up to the first hundred. If you're a parent, do your life and your children a favor. It's easy to read, you'll rip right through it.

The Epidemic: 23-037 \$11 (or free)

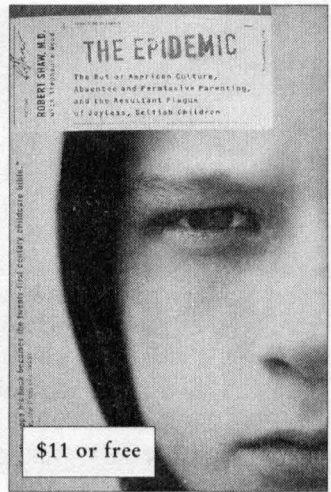

## Happy Baby & Toddler Videos

These videos teach you things you might not learn anywhere else. The cover price, for each of them, is \$23, but we sell them for cost just to get them out there.

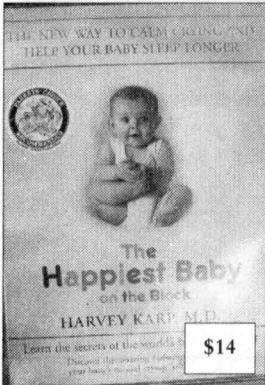

We've offered these before, and the reaction has been astounding. The Baby one tells you why babies cry and how to comfort them instantly. The Toddler one tells what frustrates toddlers, and how to communicate with them before they reach the age of reason. Good videos, by pediatrician Harvey Karp.

Happiest Baby DVD: 31-380  
Happiest Toddler DVD: 31-382

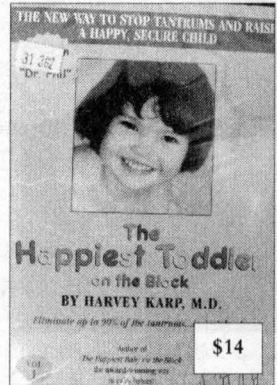

*"But I thought this was a bike catalogue!"*

Well, it is, but with slotted saddles and all, some bike riders are having children, and every now and then there's some really good information that warrants passing along. Bookstores have so many books that it's hard to know where to start. No doubt there are other good books & videos, but the ones here are standouts (outstanding), and if you're a parent, you'll be glad you got them. The videos, especially, make great gifts. The book does, too, but give it before the kids are teenagers, or at least before they're 17. At that point, maybe too late.

We wouldn't stock these if they weren't really special, or if you could find them any old place. But they are, and you can't, and so... —Grant

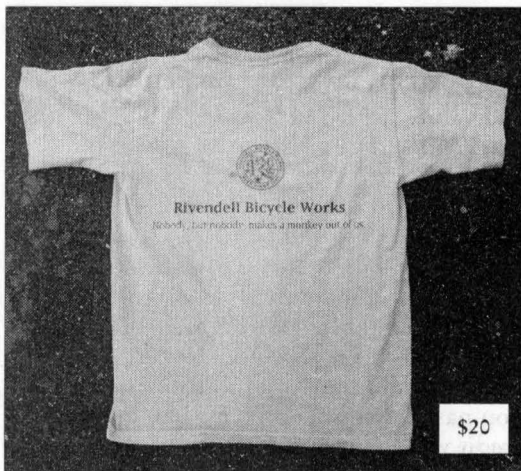

### Rivendell SS T-shirt

100 percent organic cotton, made in the USA, and dyed with clay, herbs, roots, or whatever else they can boil up or squeeze juice out of. Colors vary, but all are earth tones (mustardy, grey, light green, and so on). See [www.rivbike.com](http://www.rivbike.com) for the current offering, or just trust that if we like it, you won't hate it.

The slogans will change from time to time, and lately they've been getting pretty far out there, but we'll always keep them tasteful, truthful, and not too

embarrassing to wear in public with your spouse or children. Pre-shrunk, but buy up a size, anyway.

S: 22-571 \$20 M: 22-572 \$20 L: 22-573 \$20 XL: 22-574 XXL: 22-575 \$20



### Ocean Potion Sunscreen

We have mixed but not too mixed feelings about selling sunscreen, because every store in the world sells it, but not every store in the world sells this one. Many do, just not every.

We like it because it's pleasant enough to use every day. It doesn't smell like sunscreen. And yet one of our customers, a dermatologist, says that a vitiligo (Michael Jackson disease) patient of his, who is virtually an albino now, finds that this works better for him than anything else, and when a guy like that says something like that, you've got to listen. We use it all the time. 6oz., lasts about 3 months.

Ocean Potion: 31-346 \$12

### Gift Certificates

The perfect gift for any cyclist, wool-wearer, soap-user, book-reader, or user of refrigerator magnets. Always a popular gift, and if you're the spouse, parent, child, or friend of someone who has this catalogue, then it's a sure hit; and look at the savings.

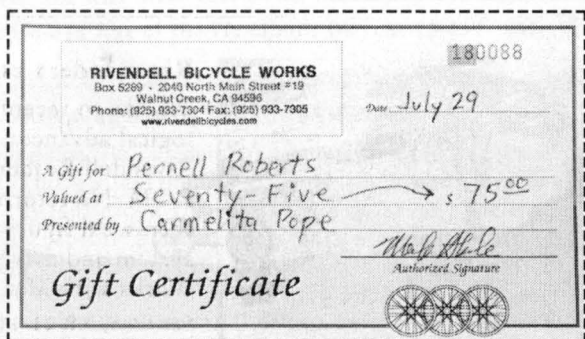

\$25: 24-082  
\$24

\$50: 24-083  
\$47

\$75: 24-084  
\$71

\$100: 24-085  
\$92



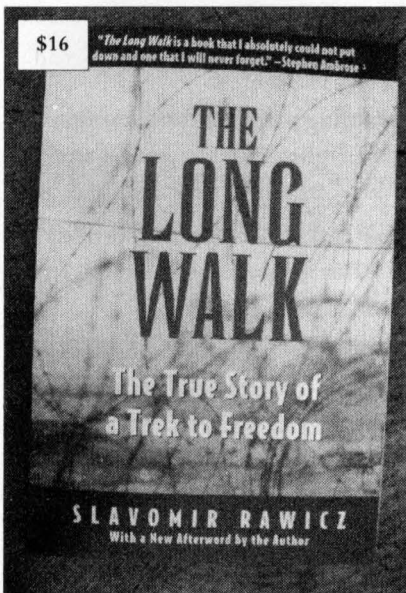

## The Long Walk

If you like true things, and can stand to read, and you like getting your perspectives and values jostled up some, and you've read *Into Thin Air* and liked it, then you'll die when you read this, because it's the most fantastic true adventure book of all time. Everybody who reads it forces it on at least one person, because it's such a good book. If you read it and don't like it, send it back for \$20 credit. Maybe we'll ask you an easy question to make sure you actually read it; like, what did they eat in the desert? But if you pass that test and didn't like it, we'll credit you \$20.

The Long Walk: 23-018 \$16

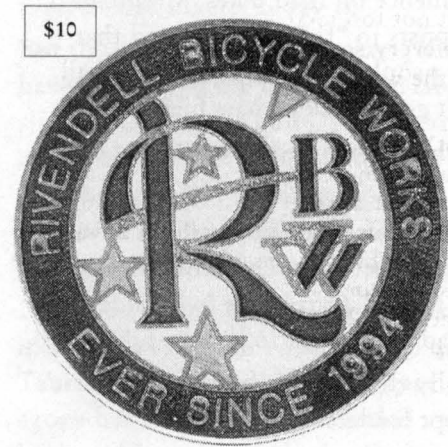

## Rare Earth Fridge 'gnet

Rare earth magnets are so powerful that they come with a warning to keep them away from pacemakers. Do that. This is your warning, and while you're at it, keep them away from credit cards, too.

But when it comes to holding things up on non-stainless steel refrigerator doors, they're the way to go times ten. This one is a cloisonné badge (copper with fired enamel filling), and has our logo. It comes to us with a lousy magnet, but we don rubber gloves and safety glasses and glue on the rare earths. That's what we do, and it's worth \$10.

RBW refrigerator magnet: 24-062 \$10



## Riv Readers on CD. Ten dollars per Set.

Thanks to recent, epoch-making technological advances, we offer back issues of the Rivendell Reader in PDF format on CD-ROM. No returns on functional CDs, because then we'd figure you're just out to beat the system and drive us into the poor house. Works with Mac or PC.

Set One, RR 01-11: 24-127 \$10

Set B, RR 12-21: 24-128 \$10

The Third Set, RR 22-25: 24-129 \$10

Quatro, RR 26-35: 24-156 \$10

## Copying the Wrong Bikes & Riders

---

In the last quarter century racing's influence on riding attitudes and bicycle design has been devastating, deplorable, and downright depressing.

The old notion that "racing improves the breed" sort of held water fifty years ago when only professional parts had good metal and construction methods (although French touring bikes in the '40s really started it all). But racing usually gets the credit, and it's hard to make that case nowadays. It's still true that most innovations get tested by pro racers first, but these days that's a marketing strategy. Pro racers aren't paying customers. Ten-cog cassettes trickle down to riders and bikes that'll never see a race, and rather than "improving the breed," they just turn what should be a more affordable, versatile road bike into a racing wannabe.

Racing got its grip in the mid '80s, when American racers started doing well in Europe and getting famous. The media made heroes of them, the market for racer-wannabe bikes exploded, and touring got the boot.

While this was going on, mountain bikes were just taking off, and for all the good they've done, they too had a bad influence on road bikes. Mountain bikes were sized small and used long seat posts to "fit" the rider, and that spilled over to road bikes, to a fault. Now people buy road bikes too small and use long seat posts, and find they can't get the handlebars high enough.

But the mountain bike's influence was nothing compared to the racing bike's. Specifically...

Whippet-like racers ride hard, skinny tires because they give a slight advantage when the surface is smooth and speed is all that counts. Those tires don't make sense on a normal ride, but it's hard to find a road bike (with sidepulls) that'll accept more useful tires, because road bikes want to be race bikes.

Racers don't ride with fenders, and generally think they're nerdy, so now it's hard to find a road bike that can even accept fenders.

Racers ride with low handlebars and flat backs because it's more aerodynamic, and aerodynamics can be important in a race. Most of today's road bikes force non-racers into the same position, but that position is lousy for anything except racing. Threadless headsets became popular in racing, trickled down to non-racing bikes and make it hard to raise the handlebars.

Racers have contractual obligations to sport their sponsors' colors, and because of racing's influence, most people think that if you're serious about riding you need to costume up. I bet that keeps more people off the bike than traffic does, and sends the message to would-be riders that they can't just get a bike and ride it in the clothing they've got. They have to look like pro-ish. If you're used to wearing clothing that doesn't draw attention, it's a high hurdle to squirm into a suit of gaudy spandex; and so unnecessary.

Racing bikes are made of the lightest materials, because racers are superlight themselves, and they don't ride the same bikes year after year, so durability doesn't matter as much. A normal rider looking for pleasure and long-term use has nothing to gain by riding a featherweight.

I don't wannabe a racer or look like one. I don't wannaride a wannabe. I wanna road bike for smooth roads and rough, for dry weather and wet. A comfortable bike that's still plenty fast, and can tote me alone or me & spare clothes and a sandwich or more—and a racing bike wannabe cannado it.

We're not against racing, racing bikes, or racers.

All we're against is how manufacturers, egged on by the media and many bicycle dealers, model all road bikes after racing bikes. It's better to let racing bikes evolve as they will, let the clothing turn into spray-on, let helmets and sunglasses turn even more cone-like, and let road bikes return to normal.

You know what really "improved the breed?" Touring.

In the mid '70s and early '80s, bike touring was the rage, and again was the impetus behind dramatic improvements. Most of those tourists stopped touring, but continued riding and wanted good equipment. It so happens that what makes sense for touring makes sense for just about any kind of riding, and as a result, the typical road bike back then was five times as useful as the typical road bike of today is.

But throughout the racing years (which we are still in), product managers have considered the touring bike label to be the kiss of death. When the thin, slick, fasties get the glory, people don't want to cart junk around on their bike and camp for the night, and then do it again tomorrow. Nobody famous does it. Touring has a bad image, too, because it's so much more fun than it looks—or put another way, it looks like a death march. When you see loaded up bike tourists on the road, how many of us think, "Wow, that looks grand?"

It may *be* grand, but it doesn't look it. Not from the dry, air-conditioned inside of a car, with your favorite music playing and a lap full of snacks. Touring has the additional baggage of already having had its day. Once a category has had its day and fizzled away, it's almost impossible to bring it back and have people look at it in a new light.

So I think we need a new category: Country Bikes.

It's new, and fits between road bikes and mountain bikes. The "country" can include paved roads and mountain trails, but as a category, it's new and separate from racing-road bikes and gonzo-racing mountain bikes.

A Country Bike is just a road bike designed for comfort and versatility. It has 32mm to 38mm tires, fits fenders easily, can carry racks and luggage, but is still zippy when you strip off the extras. It's a bike without racing's influence. It's not going to be the ticket for racer-wannabes, but it's just right for 90 percent of the rest of us.

People don't like change, and they don't like the idea of labels. But in this case, something has to be done, and it would be easier to make a new category than get road bikes back on track. It's not going to be an all-consuming mission, to establish "Country Bike" as a category, but as categories go, there could be worse ones. They aren't road bikes by current standards; or mountain bikes, or comfort bikes or city bikes. —Grant

The Rivendell Reader

We are in our 12th year of publishing this, a quarterly (at best) cycling publication intended to be a general purpose cycling magazine for non-racers, but winds up being heavily biased toward the kinds of cycling and cycling products that we like. It would be strange to publish a magazine about the kinds of things we didn't like, wouldn't it? The Reader has interviewed many of the most influential and interesting personalities in cycling, from Jobst Brandt to Sheldon Brown to Lon Haldeman to Maynard Hershon to Alex Moulton to Kozo Shimano to Richard Sachs and several others.

Although the Reader is chiefly a cycling magazine, every other issue or so has something in it not related to cycling. It may be a lipomatic contest, or a reprinted article from another publication (always with permission), written by such literary luminaries as Wendell Berry, Ian Frazier, and Danielle Steele.

On top of that, there's useful information in it that you're unlikely to read about anywhere else. A typical issue is 48 pages long, carries no advertising, and I am proud to say that as we approach our 40th issue, I am quite sure that the word "very" has not appeared even once. I think we can all agree that makes up for the numerous typos (fewer in recent years than there were early on).

Subscriptions are \$20/4 issues, \$35/3 years (about 12 issues). With each subscription you become a "Rivendell member," and receive a \$10 credit toward anything in this big, mean world. There are worse deals out there in this big, mean world. You may subscribe by phone, fax, or online. Of course we accept credit cards! The two main ones.

US \$3.50, unless you subscribe

THE RIVENDELL READER

Issue No. 32 Spring 2004 RIBR Spring 2004 Issue No. 32 A Secret Magazine for Bicycle Riders



When Song Censors Worried About Louie Louie

The Louie Louie song has been a staple of rock and roll for decades. It's a song that's been covered by hundreds of artists, from the Kingsmen to the Beatles. But in recent years, it's become a target of song censors. Some people think it's too raunchy, too sexual, or too vulgar. But for many people, it's just a fun, catchy tune. It's a song that's been a part of many people's lives, and it's a song that's here to stay.

Three shoes for pedaling

In our continuing, if patient quest to get you to try pedaling from just one, we hereby show you three options; two of which are actually de-bias.

FAVA BIANCHI 52W
These shoes are a mixture of our riding life at the Rivendell. They're light, they're fast, they're comfortable, and they're a good value. They're also a good choice for people who want to ride for a long time without getting too hot. They're a good choice for people who want to ride for a long time without getting too hot.



Shimano shoes
Shimano shoes are a good choice for people who want to ride for a long time without getting too hot. They're a good choice for people who want to ride for a long time without getting too hot.

Adidas shoes
Adidas shoes are a good choice for people who want to ride for a long time without getting too hot. They're a good choice for people who want to ride for a long time without getting too hot.



RR 32 SPRING 2004
Well-timed, late-winter weather with...
This winter, the 48th issue was...
Large, the most well-timed weather...
This should be a good one. It's a...
Different thinking of fall...
This is a good one. It's a...
This is a good one. It's a...

THE RIVENDELL READER
QUARTERLY FOR BICYCLERS
Issue No. 35 Spring 2005 RIBR Spring 2005 Issue No. 35
In This Issue
Cup of tea
Bicycle
Bicycle
Bicycle
Bicycle
Bluebells blaring where the Aberdeen waters flow
O...
This publication exists to...
A Rivendell member...
This is a good one. It's a...

## Company History & Mission

From late '84 to late '94 I designed and spec'd bicycles and worked on catalogues for the U.S. division of Bridgestone Cycle, Japan's largest bike maker. Bridgestone closed the U.S. office after ten years of no profit, when the dollar-to-yen exchange rate plummeted to the point where it became impossible to even break even. I was 40, and started Rivendell with \$89,000, a mix of savings, retirement, severance pay, loans, and money raised by selling stock to friends.

True to the cliché, Rivendell was in my garage for two years. Now we have 5,000 square feet at about \$0.90 per square foot, one of the cheaper rents in town. We like it here a lot. It's easy to get to, close to good food and riding and public transit, and it feels like home, except that summertime temperatures average 90°F and winter days rarely get above 57°F.

We've been profitable two of the past eleven years, but cash flow is neutral. Sales are about \$2.2 million dollars per year. We're just breaking even, there are no top-heavy salaries, and we fret a lot during slow weeks (and months). I do, at least.

Our mission is to make things that wouldn't be made if we weren't here, to offer an alternative to racing-centric bikes and parts, and to espouse a different approach to riding. And to resurrect and keep healthy many of the better ideas, designs, and styles of bicycles, clothing, and accessories that we personally like to use or wear. To sell lots of wool, and wipe synthetic fabrics off the face of the earth by the year 2010. That's a joke. To still be around in 20 years. That would be great, no joke.

If you'd like to know more, ask. It's not a secret business we have here.

### Trivia about our name

*Rivendell*, of course, came from J.R.R. Tolkien's *The Lord of the Rings*. In Middle Earth, Rivendell was an elfin sanctuary where weary travellers could rest in safety, and where elves made light, smooth, flexible things that didn't break and did repel arrows. That's a matter of fact, but I'm not obsessed with Middle Earth. Now and then we borrow a name from the book, but that's because the names are good. Quickbeam, Baggins, Bombadil, and Legolas (the latter two have yet to surface, but they will)—are easy to pronounce and weren't already taken by other bikes. But there's more behind our name than the book. You see...

In the '70s there was a mountaineering equipment company called Rivendell Mountain Works. It was started by a fellow named Larry Horton, who is now a doctor of Chinese medicine, practicing in New Mexico. RMW equipment was as against-the-trends as ours is, maybe more. I used it, liked it, and it shifted my way of thinking about equipment's role in an outdoor experience. *How much should gear do for you?* That was a good question thirty years ago, and is a great one now. Anyway, RMW's flagship product was the Jensen pack, a large capacity mountaineering pack designed by climber Don Jensen, who later died in a bicycle accident in Scotland. (And just this year I found out that in 1961 he graduated from high school a mile and a half from here.)

The Rivendell Mountain Works Jensen pack proved that a pack big enough for multi-day loads not only didn't require an external frame, but with the right design, was better off with no frame at all, not even an internal one. It wasn't stuffed with padding, either. Empty, you could wad it up into a ball. Full, it carried so well you could do cartwheels.

As is often the case with good things, it was too radical for Dubuque. But it created a stir in the mountaineering world, and in the late '70s it spawned scores of semi-imitators that pushed the right buttons to achieve mass appeal, and were made by companies big enough to support them with the manufacturing, promotion, and distribution essential to commercial success. Little ol' Rivendell Mountain Works couldn't compete, and in about 1979, closed its one door (it was housed in a vacated one-room church in Victor, Idaho) for the last time.

I like the way *Rivendell* sounds, but naming us after them also gave me something to live up to. RMW didn't make goofy things, and wasn't impressed by chintz & flash. It didn't exaggerate claims, cave in to market pressures, or veer off its course. That's our plan, too.

Business champs say it's important to be flexible, and remake yourself at the first sign of a hot new thing. Most big bike companies follow that advice, which is explains their sameness, and if the volume is there, maybe they have no choice. Our existence, on the other hand, depends on a good amount of inflexibility and dogmatism. But inflexibility and dogmatism alone just aren't enough. We know we're on the fun road and we think it's the right road, but a little patronage now & then keeps us from dying on that fun, right road. A noble death, maybe or maybe not, but all things considered, all of us here want to keep working. —Grant

*Flash! I just found out that one fellow owns the name rights and the patterns of Rivendell Mountain Works, and a friend of his makes Jensen packs to order. Google Rivendell Jensen Pack, and go to the site. —G*

## Head shots and quick blurbs

### MARK ABELE

born San Francisco, 1958

worked here since May 2002

other thing I like to do cook

person I most admire hard to say

place I most want to go Tuscany

if all food were equal Short ribs, mashed potatoes, beans, Tiramisu, and old vines Zinfandel



### MARY ANDERSON

born Minneapolis 1958

worked here since October 1994

other thing I like to do read, hike, quilt

person I most admire my parents

place I most want to go Sweden

if all food were equal vanilla ice cream w/crumpled chocolate brownie



### JOHN BENNETT

born St. Louis, 1956

worked here since 2000

other thing I like to do walking the dogs

person I most admire George Harrison

place I most want to go Mongolia

if all food were equal vegan Japanese

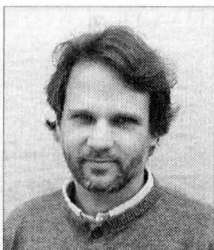

### MIESHA CASON

born Oakland, 1976

worked here since 2004

other thing I like to do relax w/family at home; watch movies

person I most admire my mom and Oprah Winfrey

place I most want to go Paris

if all food were equal T-bone, buttered mashed potatoes, steamed broccoli



### BRIAN "TORQUE" DOUGLAS

born Chicago, in the fifties

worked here since June 2004

other thing I like to do things with my wife, piano, movies, outdoors

person I most admire F.D. Roosevelt, P. McCartney, Jos. Charles

place I most want to go the Black Hills, the Ukraine, New England

if all food were equal Mediterranean-Italian seafood, angel hair pasta primavera, salad, white wine, and dark chocolate



### MODESTO FLORES

born San Jose, CA, 1949

worked here since 2001

other thing I like to do watch Buccaneers football

person I most admire my mother

place I most want to go France

if all food were equal lengua burrito

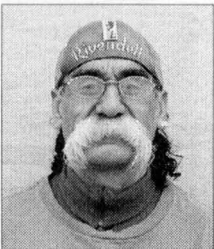

**ROBERT KUROSAWA**

born Honolulu  
 worked here since 2000  
 other thing I like to do watch tv, read magazines, and sleep  
 person I most admire my mom  
 place I most want to go home, after work  
 if all food were equal all-you-can-eat Japanese, Hiroko's cream puffs

**RICH "CONDIMENT" LESNIK**

born Longbranch, NJ 1946  
 worked here since late 2002  
 other thing I like to do play the saxophone  
 person I most admire John Coltrane  
 place I most want to go across the U.S. again, on a bike  
 if all food were equal eggplant curry, veg. Biryani, lentil dal, nan.,  
 condiments. Just try to keep me away from condiments! Can't be done.

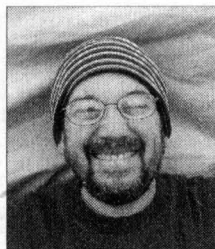
**DANIEL MOLLOY**

born Redwood City, CA 1981  
 worked here since January 2006  
 other thing I like to do read the Financial Times, speak German  
 person I most admire mom and dad  
 place I most want to go Spain, Italy, Germany  
 if all food were equal ok now: choc. covered, pnut butter-filled pretzels,  
 twice baked potato, Tullio's (local) Pizza, chocolate milk, Porter beer

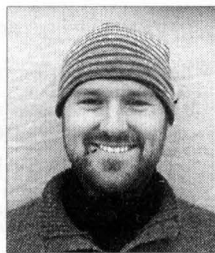
**KEVEN MOWEN**

born Santa Clara, CA 1978  
 worked here since November 2005  
 other thing I like to do run  
 person I most admire my parents  
 place I most want to go Tibet  
 if all food were equal peasant pies and arizmendi pastries

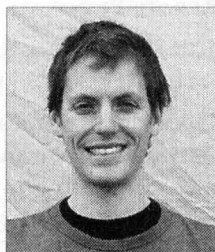
**STEPHANIE WYRICK**

born Tracy, CA 1984  
 worked here since October 2005  
 other thing I like to do guitar, sing (I'm in 3 bands), photography  
 person I most admire my brother and Sophia Loren  
 place I most want to go India and Australia  
 if all food were equal a frosty Boont, tempura-battered fish tacos, gorgonzola mac & cheese, hanger steak, green tea ice cream, ginger cookies

**GRANT PETERSEN**

born Berkeley, 1954  
 worked here since October 1994  
 other thing I like to do fish, hike w/ family, friends, dog; take photos.  
 person I most admire Jimmy & Rosalynn Carter, and Sophia Loren,  
 especially from 1958 thru 1967, maybe 1968.  
 place I most want to go Labrador, for the brook trout  
 if all food were equal egg nog ice cream w/butterscotch sauce & walnuts, with a chocolate  
 brownie, macaroon, and baklava. Plus fresh figs and apricots and barbecued salmon.

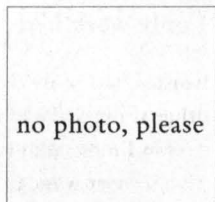

## Prices, returns, shipping, a rebate, and our guarantee

### PRICES

Everything we sell is priced to the even dollar, and nothing ends in a 9. It's been that way for 11 years. The only exception is Einstein's patch kit. Try as we might, we couldn't justify an even-dollar price on that one item.

### RETURNS

We hate returns! But they're inevitable. Listen, if you buy something from us and for any reason don't like it, you have three months to return it for cash, and a year to return it for credit. In the past we've had folks use something hard, wear it out, and return it for cash. It's rare, but in this case we're designing the policy to protect us from the exception. We use and wear the things we sell as hard as anybody, and in some cases definitely harder, so you can buy with confidence. Our product descriptions are sometimes long, but always honest.

### SHIPPING RATES (FOR ANYTHING THAT'S NOT A FRAME, WHEEL, OR BIKE)

When your order is over \$150, we pay the ground shipping to the lower 48 states. Our freight costs continue to go up, but we're not passing it on to you, because expensive shipping takes the fun out of ordering. And as you may notice, we haven't jacked up the prices to account for it.

For more detail, see the order form.

### REBATE PROGRAM

This is new, retroactive to January 2, 2006, and continues at least until the next catalogue comes out, at which time we'll review it and see how it's working:

**Twice a year—at the ends of June and December—we'll tally your non-bike, non-frame purchases, and calculate a store credit of 5 percent of that amount. By the ends of August and February, we'll have created a credit on your account, and will tell you how much you have in your Rivbank.**

If this proves to be a logistical, administrative, or financial disaster, we'll call it off after 2006.

### GUARANTEE

We guarantee that we want you to be happy with everything you buy from us, and will go out of our way to make that happen. Disgruntled customers are rare enough that we don't have a set plan for how to handle them. Internally, everybody you speak to has the authority to solve any problem you have. They are free to pass you up and down the ladder if they feel somebody else can take your guff more easily, or will just be able to help you better, but it's never a matter of "I only work here, I have no authority..."



Name \_\_\_\_\_ Member # if known \_\_\_\_\_  
 Mailing/billing address \_\_\_\_\_  
 City \_\_\_\_\_ State \_\_\_\_\_ Zip \_\_\_\_\_  
 Ship to, if different \_\_\_\_\_  
 Work phone: ( \_\_\_\_\_ ) \_\_\_\_\_ Home phone: ( \_\_\_\_\_ ) \_\_\_\_\_  
 Fax: ( \_\_\_\_\_ ) \_\_\_\_\_ Email: \_\_\_\_\_

**If Something is Out of Stock**  
 \_\_\_\_\_ Ship back-ordered items as available  
 (backorders shipped freight ppd).  
 \_\_\_\_\_ If it's not in stock, don't back-order it.  
**No backorders on items less than \$20.**  
**That's because we pay the freight on back-**  
**orders, and our shipping cost easily eats all**  
**of the profit. No int'l backorders.**  
**If no line is checked, we'll backorder.**

**Shipping & Handling**  
**Parts up to \$149: \$8. \$150+: FREE (exc. noted)**  
*Next Day.....\$35 2-Day.....\$20 3-Day.....\$12*  
*Rims.....\$15 (any qty) or Wheels.....\$15 (each)*  
 Bikes and frames: Call or see our site. We're working  
 on getting lower rates, but holy cow, it's not easy.  
**International** \_\_\_\_\_ **Ground Air**  
 Canada (USPS unless you request UPS).....\$15 \$25  
 All other countries.....\$25 \$50  
 P.O. Boxes, AK & HI: \$10 Priority Mail, restrictions apply.  
 Call for int'l rates on shipping frames, wheels, bicycles.

Item #	Brief Description	Qty.	Size	\$ Each	Total

Subtotal	
Tax (CA only)	
Shipping: \$8 up to \$149; \$150+ FREE (no rims, frames, bikes)	
<b>Take \$10 discount if you renew or sign up now</b>	
<b>GRAND TOTAL:</b>	

P.O. Box 5289 • Walnut Creek, CA 94596  
 Phone: 925-933-7304 • Fax: 925-933-7305 • Fax Toll-Free in US: 877-269-5847

**PAYMENT**

Check or Money Order No.: \_\_\_\_\_ Amount: \$ \_\_\_\_\_

Visa/Mastercard:

Expires (MM/YY)  -  **Three digit code on the back:** \_\_\_\_\_

**Become a Rivendell Member for \$20.**  
**Get a year's subscription to the Rivendell Reader,**  
**money-saving coupons, and seasonal Catalogues.**

*Look what your \$20 gets you:*

**1. Member prices on everything in this catalogue**

The prices listed are the low, Member prices. Non-members pay \$5 more per item.

**2. Rivendell coupons**

Every now and then, a couple of times a year, we'll print Rivendollars in the Reader. These are good toward qualified purchases, but only members can use them.

**3. Our quarterly newsletter**

It's called the Rivendell Reader. A typical issue is 32 to 40 pages long, and contains stories, articles, and interviews that you absolutely, positively will not read in any other cycling publication.

**4. Our catalogue**

We aim to have one come out every season of the year. It never actually happens that way.

**5. Ten dollars off your first order**

If you fill out the form below, and place an order as well, you can take \$10 dollars off the total. There's no funny business. Fax or mail orders only, please.

Note to Members: You can extend your membership by a year or more, and get the same great deal.

Name \_\_\_\_\_ Member # if renewing \_\_\_\_\_

Mailing/billing address \_\_\_\_\_

City \_\_\_\_\_ State \_\_\_\_\_ Zip \_\_\_\_\_

Ship to, if different \_\_\_\_\_

Day phone: ( \_\_\_\_\_ ) \_\_\_\_\_ Home phone: ( \_\_\_\_\_ ) \_\_\_\_\_

Fax: ( \_\_\_\_\_ ) \_\_\_\_\_ Email: \_\_\_\_\_

Membership Order Form	Total
Sign me up for one year: \$20	
Make it two years: \$30	
I'm a math wiz & I like a good deal: Three years: \$35	
I'm young, rich, and committed. Make it 99 years: \$400	
I'm a foreigner who wants to try it for a year: \$25	

P.O. Box 5289 • Walnut Creek, CA 94596

Phone: 925-933-7304 • Fax: 925-933-7305 • Fax Toll-Free in US: 877-269-5847

**PAYMENT**

Check or Money Order No.: \_\_\_\_\_ Amount: \$ \_\_\_\_\_

MasterCard/Visa:

Expires (MM/YY)   -   3-digit security code: \_\_\_\_\_

# Hours, Visiting Tips, Directions, Policies, Grub

## Telephone Hours

M-F, 9 am to 5 pm Pacific time. We're here earlier and later, but these are our phone hours. We return messages.

## Visiting Tips

We have a shop, warehouse, phone area, and a showroom that's always open, but especially Saturdays 10 to 4. We're friendly, so please come on by.

## To Find Us

From the south or west: Take 680N. Exit Ygnacio Valley Road. East on Ygnacio 1/4-mile to North Main Street. North (left) on Main about 50 yards. Turn right and go up the ramp between the bakery outlet and Hertz. We're halfway down the left side of the metal building. It's extremely posh.

*From the north:* Take 680 S to the Geary/Treat exit. Left onto Main until you hit Pringle. U-turn at Pringle, then almost immediately turn right and go up the ramp between the bakery outlet and Hertz, then halfway down the left side of the metal building.

*A 5-minute walk from Walnut Creek BART:* Walk out the NE side of the lot, then north on the sidewalk alongside California, to Pringle. Right/east on Pringle to N. Main, cross N. Main and go up the path between the bakery outlet and Hertz Rental Car. Stay to the left of the corrugated metal building, find No. 19.

## Where To Park

In front of 18, 19 and 20.

## Where To Eat Nearby

We're a 4 minute walk from the best food in town: Tullio's. Salads, sandwiches, pizza, pasta. Big portions, low prices, great staff. All true, not an ad.

## Will Calls

Call first if you can, so we can have your order ready.

## Stock in general

We try to keep stock of everything in this catalogue, but are sometimes out of certain things.

Backorders will only be issued on out of stock items listing for more than \$20. There's no freight on backordered items, which is a strong incentive for us to

keep everything in stock. The prices listed are good until the next catalogue or price update in the *Reader*.

## Returns

If you aren't completely happy with what you buy from us, you have 60 days to return it for a full refund by check or credit card (as you originally paid).

## Payment

Visa or Mastercard, personal checks or money orders. We don't hold checks to wait for clearance, but in 11 years, we've never had an uncollectible one. If you're the first, the world will know of it! All orders shipped to California get charged your local sales tax.

## Shipping/Handling Charges

FREE SHIPPING to the U.S. on parts, clothing, accessories (anything except frames, bikes, wheels, or rims) on orders of \$150 or more. Less than that, \$8 per order.

Bikes and frames: Call for current rates.

Foreign shipping is higher, sorry, but we don't set the rates, the feds don't listen to our pleas. Call for rates.

*UPS 3-Day:* \$15

*UPS 2-Day Air:* \$21

*Next Day Afternoon:* \$35. All 3-2-1-day orders must be received by 12:00 Pacific time. If you're on the east coast, fax it in to 1(877-269-5847). We'll bust our behind for you, but cannot guarantee delivery.

*Back Orders:* Free shipping. (No Intl. Back Orders)

## International

*US Mail to Canada:*

*Ground:* \$15 / *Air:* \$25

*Other Int'l Surface:* \$25 / *Air:* \$50

*Frames & Bikes:* Call

## Pricing

Catalogue prices are member prices. Non-members pay \$5 more per item. That's usually a decent deal anyway (except on small items). It sounds harsh, but it's our way to get you to join. Joining is cheap and easy, and you get \$10 of your \$20 member fee back with your first order. It works out for you and us, and so...we like it!

**RIVENDELL BICYCLE WORKS**

2040 NORTH MAIN STREET #19

WALNUT CREEK, CA 94596

PRSRT STD  
U.S. POSTAGE

**PAID**

WALNUT CREEK CA  
PERMIT #816



\$1