

RIVENDELL BICYCLE WORKS

W I N T E R ' 0 4 - ' 0 5





Top:

Doug, Miesha, Rich, Mo, Grant, Mary, John

Bottom:

Robert, Mark and his Dog, Sterling, Brian

WE ARE LUCKY TO BE HERE, because we don't follow trends, and haven't consciously identified a market to target. We just find and make the kinds of bike things we personally like; the idea being that we're not freaks, so if we like them, you might, too. Thank goodness it seems to work like that.

Anything in the bike business is hard these years, and last year was the first ever that we broke even, so it's not like our "if we like it/you'll like it" approach is a winning model. It's our model because it seems natural to sell things you like rather than things you just know to be popular.

In the past 15 years, the persona of bicycling has changed. Now the mark of a "serious" cyclist is a snug-fitting garishly decorated synthetic jersey, lycra pants, slender wrap-around sunglasses, and an "out for blood" attitude. For the most part, pros look like aliens, amateur guys look like pros, and women look like guys. A serious *bike* is either a complex machine designed for downhill racing on rough terrain, or a 17-pound featherweight road racer that's fine for smooth dry roads & little else. We're sort of against all that.

Most impressionable newcomers in any pastime aspire to use the same equipment the pros use, because they assume it's the best. That makes sense for photographers, but not for cyclers. It may have made sense back when pro racers had to repair their own bikes, We're not saying those were the good old days, just that pro equipment born in the era of the support vehicle doesn't have to be as durable, and often isn't.

The modern high-end road frame is engineered to win this season's weight war, to give sales reps and retailers bragging rights, and to give a featherweight racer a slight real or psychological advantage in a mountaintop finish. It rarely accepts a tire larger than 700x25, so it's not suitable for rough roads, or for riders weighing more than 190 pounds. It doesn't let you mount fenders, so it's no good for wet roads or rain. For anything other than racing or pretending to race, it's not the super ticket. When you take an already lightweight frame and remove material until it raises eyebrows in 2004, something has to give, and within a month of its introduction, one major lightweight came back with 12 failures. A front derailleur clamp buckled the seat tube. A top tube folded while a fellow was balancing the bike (doing a track stand) in the showroom. This same bike has a lifetime guarantee, with no rider weight limit. It is extreme, but in the context of other featherweights, it has close cousins. Weight is way oversold, because everybody can relate to it. Our take on weight is this: Light is good, but lighter is not necessarily better. Be smart about frame weight. Get something light enough, beautiful, and strong.

Here at Rivendell, we try to be practical in what we ride, espouse, and offer. Much of it is the best in the world, but we don't cater to racers, and that opens the door to some pretty fine gear. All of us commute by bicycle, too, so you'll find a good assortment of practical gear. The mix in this catalogue might strike you as odd, with a \$335 Phil Wood cassette hub on one page, and \$20 pedals on another, but every item earned its spot by being the best of its kind, or the best value, or the only option. We sell things we like and know and ride, and when you order from us, you can count on liking them just as much as we do.

We are particularly proud of our shipping department. Mis-ships are rare, and Robert and Mo have elevated the job to a level I've never before experienced, and the package you receive from Rivendell will likely be the best-packed box you receive all year.

We have a website: www.rivbike.com. You can read more about us as a company, and things we sell, and can order online there. It's a complicated site, but a good one.

—Grant, Sterling, John, Mark, Mo, Robert, Rich, Mary, Miesha, Brian, and Doug, our unpaid intern.

BIKES, FRAMES, APPROACH 2

WEAR WHAT GROWNS, AND WOOL 10

HELMET 19

BAGS AND RACKS 20

HANDLEBARS & RELATED THINGS 32

STEMS 46

SADDLES & SEAT POSTS 53

SHIFTERS & SO ON 59

CRANK & RELATED MATTER 67

PEDALS & OTHER DRIVE TRAIN PARTS, AND SUCH; AND BRAKES 70

BRAKES, LEVERS, CABLES, THEN TIRES, FENDERS, PUMPS, AND PATCH KITS 75

COUPON AND PRICING 98

HISTORY, MEMBERSHIP/SUBSCRIPTION INFORMATION 102 plus



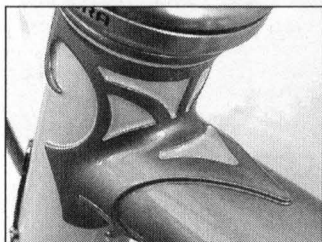
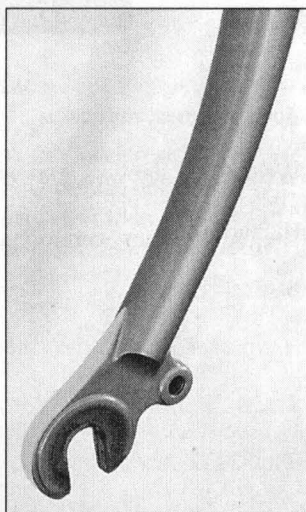
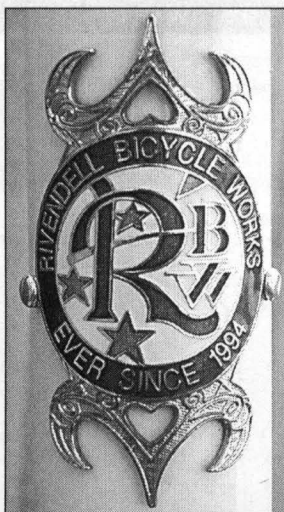
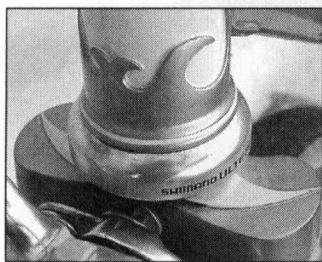

Buy it pretty, but get it dirty

When I am working on a problem, I never think about beauty...only of how to solve the problem. But when I have finished, if the solution is not beautiful, I know it is wrong.—R. Buckminster Fuller

Just because a bike is lugged steel doesn't make it good, and just because a bike is beautiful doesn't mean it's a dainty Sunday dandy. When a bike is *all* right, everything comes together—the material, geometry, paint color, graphics, bridge locations, clearances, spacings, lug details and resulting joint strength and appearance. A pretty bike with wrong dimensions and misplaced brake bridges is just as much a shame as a well-designed bike that's hard to look at. Actually, even more.

Getting the right dimensions and putting things (like bridges) where they need to be just takes experience, care, and arithmetic. Two out of three won't do. It's not hard, but it's not the topic at hand, either. *That* is appearance.

The top of the fork crown is a good place to start. Most modern bikes have no crown, so there's nothing to see. The more you don't see it, the more oblivious you are to what you're missing (namely, a nice thing to look at).

The *rake* of the fork (the shape of the bend and how much) is huge. Ideally, the rake will start low and continue without an increase in radius, all the way to the dropout. The centerline of the blade should intersect the centerline of the dropout. The dropout slot should be dead vertical, and the dropout-to-blade transition doesn't have to be as fancy as you see up there, but it should look nice.

Tubes matter a lot. You can't just add and take away material and reshape it any way the computer tells you to and have the bike look good. Computers are famous for having no taste, and bikes that rely heavily on CAD prove that. A bicycle, being a man-made object and all, can't have the organic & beautiful proportions of a tree or a feather, but certain proportions that we've seen so often in nature and have come to regard as "proper" or "perfect" should be mimicked as much as possible—without going nuts—in the tools we use and the bicycles we ride every day.

Round tubes never look bad, and are structurally better. A bicycle should be circles and triangles almost everywhere you look. Also, when there's a like amount of space between the back tire and the back of the seat tube, and the front tire and the front of the down tube, that looks good. The frame itself looks best when you can see it as a whole, and uninterrupted by unexpected & unfamiliar paint and decals.

Familiarity plays a big role in this. If you're used to seeing a headset on a bike, it's hard to warm up to the incomplete look of a hidden headset. If you expect the bend of a drop bar to be round and it has an "ergonomic" bump, it's like getting stung in the eye by a bee. Also, the bumps make it harder to move your hand around, so are *less* ergonomic, by the way. A continuous curve in a handlebar bend looks and works better.

When I see a frame joint that isn't lugged, my first reaction is "Hey—they forgot" But you can't just *forget* lugs. If it's a matter of cost, fine, just say it, there's no shame in that. But don't put a minimalist/zen/less-is-more spin on a decision that's based on economics.

"Form follows function" is a nice concept, but it's easier to get function than form. Some people may think the opposite is true, but I don't. Take a look around out there, and see what you think.

Bikes have to work, but they should look right, too. Naturally it's more important just to ride and get healthy and be green and happy than it is to sport around, nose-in-the-air, on a classy bike. But once all the dimensions are right and the bridges are correct, you can do anything in the world on a beautiful bicycle, and so why not?

A beautiful bicycle becomes more beautiful with dirt, scratches, frayed bar tape, stained saddles, and other proof of use and age. The bike needs to show some history, or else it's a sissy toy, and you don't want that. —Grant

Material Matters

It's been said that most people care about three things: sex, money, and food; and that cyclists care about four more things: price, number of gears, peer approval, and weight. This is about weight, and safety too. They are related.

Weight has been overemphasized by the media, and manufacturers have responded with frames and components that live on the brink of failure. If you haven't heard of them or seen the photos of snapped forks and handlebars, you're just out of the loop, because they're out there.

How safe a bike or part is depends on many things, but in this box we'll talk about different types of strength, and how they relate to safety.

Impact strength is how much impact a part can take before it fails. It matters, but any impact that tests a bike or part's impact strength will send you to the ground long before the part is damaged, and once you're down, who cares about the part?

Fatigue strength is how a material responds to repeated stress, usually flex. It is important in a bicycle because there's always flex happening, as you push on the pedals and pull on the bars. Aluminum has the worst fatigue strength of any common frame material, but aluminum bicycle frames can be made with oversized tubing to eliminate most of the flex. High quality steel has the best fatigue strength of any frame material. It has a stress threshold below which it can survive an infinite number of flexes.

Toughness is a material's ability to stop a nick from growing into a crack, and a crack from growing into a failure. Steel creams aluminum, titanium, and carbon fiber in this area, too. That's why hammers, nails, rebar, and bridges are steel.

Tensile strength (UTS, for ultimate tensile strength) is the most commonly cited (in the cycling media) gauge of strength, but it is a minor factor in the life of a frame, because bicycle frames don't fail in tension (the material doesn't pull apart). Frames and parts almost always fail due to fatigue, notch-sensitivity, lack of toughness, or impact. Window glass has a tensile strength five times higher than chrome-moly steel, but tension isn't what kills it.

In general, when we're talking about the variations or alloys used in bikes, the best-to-worst ranking is: Carbon fiber, steel & titanium, aluminum. Tensile strength affects safety, but any of the materials used in bicycles has plenty of it. There are factors more important than tensile strength.

Failure mode is one of those "more important factors." It is how suddenly failure occurs after the first crack, hole, or gouge. Materials that fail fast are said to fail "catastrophically." Of all materials used in bikes, none fails more catastrophically than carbon fiber, and none fails more slowly than steel. You want your bike stuff to respond to trauma by bending and denting, not shattering and snapping. Metals tend to do that. And once that's covered, you want plenty of time and lots of warning between the onset of failure (a crank, for instance) and total material separation. Steel is the first place winner here, too. Repairability is desirable, too, and steel wins that one, also.

Age and weathering is how well a material's mechanical properties hold up over the years and with exposure to the environment (heat, cold, salt air, and ultraviolet radiation). Metals age and resist weathering better than the non-metals used in bicycle frames and parts (rubber, plastic, carbon fiber). The resins used to hold the layers of carbon fiber together degrade with exposure to ultraviolet. Rust and corrosion ("rust" being steel-specific) are protective responses to environmental conditions, and once a layer has built up, they become a protective layer against further corrosion. Even so, it is best to prevent corrosion in super-thinwalled steel tubes by spraying them with any number of anti-rust sprays readily available.

Defect tolerance is discussed more in rocket ships than it is in bicycles. Defect tolerance acknowledges that no matter how high your standards and how strict the quality control, some substandard samples will be used in production. Defect tolerance is the ability of a material to be safe even when defective. Think of it as "What IF?" The least

continued on page 4

continued from page 3

defect-tolerant material of those we're talking about is carbon fiber. The most, steel. Defect tolerance is about the material itself, not about manufacturing standards.

Shock absorption, vibration damping, and comfort don't belong in the same category as the previous qualities, but they're terms that get bandied about a lot in bicycle media, and they warrant some mention somewhere in this catalogue, and this is the only page that makes sense for it.

Shocks get absorbed by movement, specifically compression, but there's a notion among bike riders that they can get absorbed without movement. Folks who ought to know better claim that carbon forks offer a "plush, shock-absorbing" ride, even though they don't compress when they roll over a bump. A straight-bladed, non-suspended fork of any even half-way safe material is not going to compress like rubber. Yet, the media and so many "experts" who work in retail shops and at the manufacturing level continue to praise their shock-absorbing qualities. If you want shock absorption, ride higher volume tires at lower pressure, and don't grip the handlebar as though it's a jackhammer. Suspension forks absorb shocks, but they're a mountain bike thing.

Vibration damping is another largely misunderstood quality whose real benefits may or may not be detectable by a human riding a bike. It is how long a material continues to vibrate once it has started to vibrate—presumably, when it hits a bump. Wind chimes don't dampen vibration well, which is why they bother your neighbors. Vibration is high-frequency flex. How a material flexes is determined by its Young's modulus, and how something like a bicycle frame or fork flexes is determined by its material and physical dimensions. But a bicycle isn't a pure thing, like a dangling metal cylinder; it's a composite of metal, rubber, air (in the tires) and other materials, and there's a body on it. The water is so muddied that there's no way for a human to accurately isolate "vibration damping" from all the other things going on during a bike ride, and even more, to discriminate the quality of damping, and attribute it to the proper source.

Physical comfort is how comfortable you are on the bike, and although that's our favorite topic of all time, we'll condense our take on that to these few words: Raise the bars to take weight off your hands. Scoot your seat back an inch or more farther than the experts tell you to. Bigger tires, lower air pressure. Ride loose.

Psychological comfort isn't as far out as it sounds. It just means that if the bike fits you perfectly but you have doubts or issues with it, you won't be comfortable. People, always women and usually over the age of 60, who grew up riding "girls' bikes" without a top tube often don't feel comfortable on what we call a "diamond-style" frame with a top tube, because they feel trapped on the bike, with no easy way to dismount it. On the other end of the spectrum, young male whippersnappers who are used to curling their skinny-maggot bodies over a the smallest possible frame (say, a 56cm for a 6-footer), aren't "psychologically comfortable" with a 62cm, even though they're physically comfortable on it.

We like steel bikes best, and lugged ones even better. If you've read this far, you know that by now. But the material and method mean nothing unless the bike is not only well-designed, but well-designed for you, and right for your kind of riding. Outside of the specialized requirements (or lack thereof) of racing, we like road bikes that allow you to fit at least a 32mm wide tire. We think all bikes should be able to fit fenders. Short (sub-41cm) chainstays are dumb. Modern road gearing is too high. Brazed-on front derailleurs are okay only if they're positioned right for the smallest chainrings you'll want to ride, and they usually aren't. Frame weight is 1/4 as important as bike weight, and bike weight is 1/10 as important as body weight. If you want to go fast, ride harder and more often. We're not suggesting you *should* want to go fast unless you're racing, but if you do, that's how you'll achieve it. You can buy a Lightspeed, but it won't make you light or give you speed. You have to quit eating and train harder for that.



The Rivendell Bicycle

Everything we know and believe about bicycle frame materials, aesthetics, design, and construction goes into a Rivendell frame.

Rivendell frames are made-to-measure, meaning I design them according to your body and your riding. You might wonder how that can happen without you being here. That's a good question. We send you a packet with lots of questions to answer about you and your riding. And then, if there are any more questions, or if we see inconsistencies in the answers, we'll call you for more information, or to clarify some point. There's no guesswork. We are good at this because we care and we do it a lot.

All Rivendell frames, regardless of size or purpose, have certain details and characteristics in common. They have low bottom brackets because we like how a low bottom bracket makes the bike behave on descents and in corners. They have long chain stays for better weight distribution and ride quality. They have tall head tubes to make it easy to raise the handlebars, for comfort; and they have exceptional tire clearance, so you can ride a wide range of tires.

We have one builder, Curt Goodrich. Curt is 38, lives in Saint Paul, Minnesota. He is married to Kate, and has two children—May, 5, and Jack, 3. Curt builds for us full-time, and despite his young age, he has achieved a level of skill that most builders don't in a lifetime—he has a natural proclivity for metal work, an extraordinary amount of experience (the best teacher), and the highest personal standards.

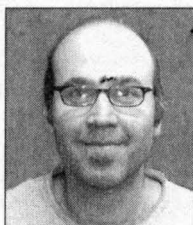

Curt Goodrich

Frame building is more than brazing and shaping metal. It also involves judgement and the ability to hit a curve ball—in the form of odd, quirky, or unique requests. Curt has seen it all and done most of it before,

and when faced with something new, he has the experience and the eye to make the best judgement. Curt is a pleasure to work with, and we're honored to have him build our frames.

Joe Bell paints them. Joe has painted frames for twenty-four years not counting ten before that, in his garage with a spray can. There are things he can do with paint that nobody else can—namely, the way he outlines lugs and masks off contrasting head tubes. Even more important to us than the obvious result, is the care and work ethic that go into a JB paint job. He takes as much pride in his painting as Curt does in his building, and that we do in the designs.

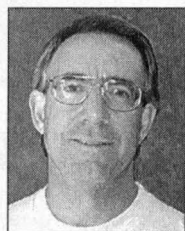

Joe Bell

As of Winter 2004, a painted Rivendell frame, fork, and headset costs \$2,500. The wait is 18 months from the day we receive your \$300 deposit. If you've got the money and can wait, you'll get the best frame it is humanly possible to make.—Grant

Atlantis: for touring, trail, commute. The most versatile bike we make.



Rambouillet: the most comfortable & best all-around road bike. Versatile.



QuickBeam: a two-speed you can ride on any terrain. Four times as useful as most single-speeds.

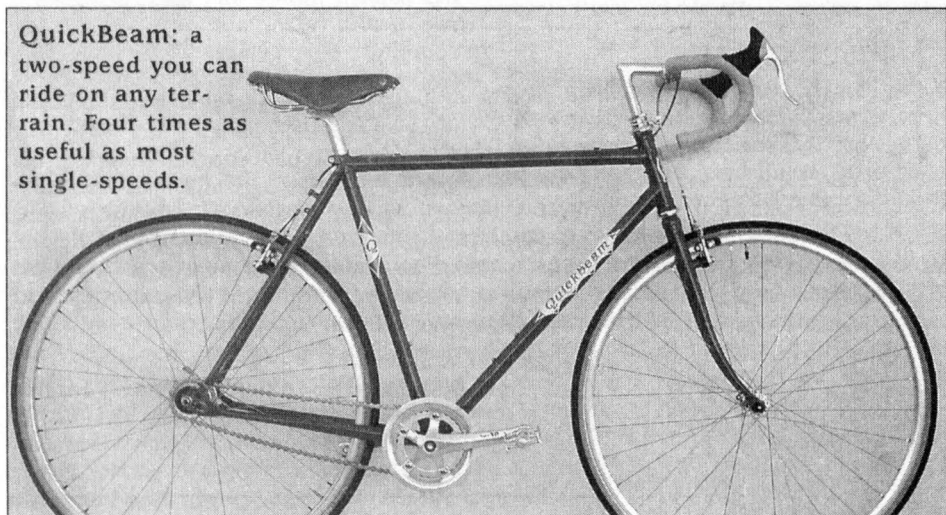

Non-Custom Models

THE ATLANTIS

This is our touring-commuting-rough riding (trails and so on) frame. If you're after a bicycle that can do just about everything and do it well, the Atlantis is the bike (or frame) for you. It's the most versatile frame we make, and we build them up to suit. About half go out with drop bars, and the others, with Albatross bars or Moustache H'bars (shown to the left there, in full-touring dress). As a loaded touring bike for road or trail, it is unequalled. Equally popular as a commute bike set up with saddlebags or baskets. The Atlantis takes a tremendous range of tires, to suit any terrain or load.

Sold as a frame/fork/headset, for \$1300. But most customers who buy that have us build it up into a complete bike, for \$2,300 to \$2,500, depending on the parts. Any kind of handlebar, any stem we offer, any gearing, any tires...and no confusion. We've built up hundreds of Atlantis bikes, and we'll make sure you get it dialed in perfectly *for you*. Sizes 47 to 68, to fit shorties or tallies.

THE RAMBOUILLET

A superb all-around road bike, far more versatile, more comfortable, more practical, and more durable than anything in its price class, and any racing or mock-racing bike currently made. It comes with our own Ruffy-Tuffy tires and a full complement of Nitto hardware. It readily accepts fenders, so you can ride it in all weather, all year round. Every part on it is a keeper, not just a "good enough compromise until you can afford to upgrade." When 90 percent of your riding is on the road with no or light luggage (say, up to 20lb), the Rambouillet is the bike to get.

Sold as a frame/fork/headset, for \$1300, or as a complete bike (minus saddle, bar tape, and pedals) for \$2100. The parts are standard, and include Nitto bar-stem-seat post, Sugino triple crank with 48x36x26 rings, a mix of Shimano 105, Ultegra, and Dura-Ace parts, Araya rims with butted spokes, Ruffy-Tuffy tires, Tektro inter-rupter brake levers standard, and 9sp 12x27 cassette. If you need a different stem length or bar width, we'll change it for free. A superb bike! 50cm to 68cm.

THE QUICKBEAM

The most practical, versatile, useful single-speed on the market, partly because it has two chainrings—40t and 32t. Changing gears takes just half a minute, because there's no need to flip-flop the rear wheel. Like all our bikes, it is a fine lugged steel frame with versatility and comfort far beyond what's immediately apparent. It comes with Panaracer 700x32 tires, yet fits tires up to 700x42, so if you've the legs for it, it can be trail-ready in minutes. Cantilever brakes front and rear, and fenders go on easily. The rear hub is threaded on both sides, so you can add another single-speed freewheel, making it a four-speed.

Sold as a frame/fork/headset, for \$900, or as a complete bike (minus saddle, bar tape, pedals) for \$1300. Some customization possible—handlebar style and width, stem extension, tires. Sizes 54 to 68.

Saluki: the bike no mainstream maker has the nerve to make. A do-all bike built for 650B wheels.



Glorius & Wilbury: Mixte frames for women (G) and men (W). Easy to mount and ride. Beautiful bikes, really special.



A brief note about who builds them, availability, and price

The Atlantis, Rambouillet, Saluki, and the Glorius and Wilbury are made to our exact specifications by Toyo, a 6-person custom frame shop in Osaka, Japan. There are hand-crafted frames in the best tradition of hand-crafted frames, and are just as strong and straight as frames can be. They cost less because there are no options on them, and because over the past 30 years, Toyo has developed efficient methods without shortcuts. These frames represent the pinnacle of value in bicycle frames, are hands-down better frames than 90 percent of the frames you see that cost twice as much.

The Quickbeam is made for us by National, Japan's second-largest maker. The lugs on it are simpler, the paint job is simpler, but the quality again is superb.

We try to keep these bikes in stock, but we're often out, and waits of up to 3 months are not uncommon. Call for availability or to get on a waiting list. We also have about 15 dealers. For more info and a dealer list: rivbike.com

THE SALUKI is the odd duck of our line, and like all odd ducks, it is special in a way that excites some riders, and threatens others. It's the wheel size, which is larger than a mountain bike 26-inch wheel, larger than a road 26-inch (which itself is larger than the mountain 26), but smaller than the familiar 700c wheel. The 650B size originated and was popular on French touring bikes in the '40s and '50s, and even today remains the wheel size of choice among—well, among about 75 percent of the riders who actually try it. Most 650B tires are about 38mm wide and are designed for 50 psi or so—much lower than the “hard skinnies” on most road bikes. Every road becomes Marshmallow Lane, and the drop in speed that you might expect from such tires either doesn't occur or isn't noticeable. The Saluki is ideal for road riding, touring, commuting, and light trail use. The perfect choice if you can't decide between the Atlantis and Rambouillet. Sizes 47 to 62cm. Frame/fork, \$1600. We stock a wide variety of 650B rims, tires, and tubes.

THE GLORIOUS & WILBURY are the highest quality mixte (“mix-tee”) frames ever built. This style, for the most part, gets no respect. In America it's seen as a girl's bike, suitable for occasional use, and bike makers, for the most part, put no effort into them. But in other countries they're ridden near-equally by men and women who value the easy mounting (the top tube is gone, replaced by a much lower diagonal tube). They're easy to swing a leg over or step through, which helps when you wear a skirt, or have stiff hips, or are carrying a high load on the back and don't want to knock it off with a leg. Although it's ideal for commuting and shorter rides, the way we've braced the frame makes them plenty stiff for any recreational rides, light trail use, and touring. It has a soft, gentle ride that provides instant comfort, but has plenty of get-up-&-go when the need arises. The Glorious is for women, the Wilbury is the same frame, but for men. Because the diagonal tube is so low and the effective top tube has a 4 1/2-degree upslope, the three sizes will fit most riders between 4-ft 10-in and 6-ft 3-in.

We had to develop all new lugs for the Glorious and Wilbury, and they are the most labor-intensive production frame we offer. The selling price doesn't reflect that. Frame/fork \$1400. Complete bike, for about \$2500, depending on parts. Designed for the wonderful 650B-wheels.

Should you buy a fancy bike by mail, without a hands-on fitting?

With our method of fitting, it's easy and risk-free. We've been doing it for nearly ten years and have developed a foolproof way to get you the right frame size—we've done it for about 800 custom bike customers, and 1400 or so production bike customers.

“Hands-on” is only as good as the hands that are on. Many of our customers—probably around 40 percent of them—have bikes that cost more than the ones they're ordering from us, but the bikes don't fit or feel right. We fix that. The process is too lengthy to describe here, but it centers around your pubic bone height (PBH), which we show you how to measure later in this catalogue.

Every fitter or bike designer or maker has a bias, and ours is comfort. Comfort is basic, and without it, nothing good follows—not speed, not fun, not savoir faire.

We are primarily a mail-order company, yes, but you'll find our service personal and thorough. We don't rush the process, and we don't forget about you after the sale. We welcome your questions, no matter how detailed and picky, even if you're just curious. I'd be happy to talk to you direct, or you can talk with anybody else here. Nobody fudges answers, and there's no pressure to make a sale.

Several of our dealers also sell by mail. They are trained in our methods, and you can be assured of a perfect fit from them, as well. —Grant

Wear What Sheep Grow

If a multi-headed space worm came here today and took a gander at a group of hikers, climbers, bird watchers, or cyclists, it would get a twisted idea of the clothing and equipment required to survive and enjoy the outdoors. Today, most "outdoor technical" fabrics were born in a lab indoors. And relentless promotions make even semi-sane folks wonder: Do natural materials even work?

We'd have died by now if they didn't. Wool was born before commerce and marketing. It has evolved over hundreds of thousands of years in the snowy slopes of Patagonia, the blistering wastelands of Afghanistan, and the bitter cold deserts of Mongolia. It's perfect for your Sunday ride, brevet, or extended tour.

Wool regulates body heat much better than plastic does. The structure of a wool fiber gives wool its superior "moisture management" qualities (to steal a term from the synthetics). And wool is self-cleaning and fireproof.

But what's most impressive is wool's feel, and it's a feel that's hard to describe in words. Compared to the scientifically produced consistency and plush weightlessness of polar fleece,

wool is far more variable and interesting. It has texture you can feel and see, and despite all attempts to high-techify it with computer-controlled processing and knitting, every all-wool garment, just like every sheep, has an inconsistency, a personality, that surfaces over time and with use and abuse and exposure in the world of wind, rocks, snags, and getting stuffed into and pulled out of packs and drawers. Wool has an authentic feel that's comfortable on warm days, and cozy on cool ones. Plus, it doesn't stink after you've sweated in it, so you can wear it many times before you need to wash it.

The clothing you wrap yourself in becomes your immediate environment, and plays a huge role in your outdoor experience. How it looks, and sounds when it flaps in the wind, and smells after the third day without washing, and how it feels against your skin, all depend on what it's made of.

A well-chosen wool wardrobe will take care of all your comfort and survival needs in extreme cold through extreme heat. We aren't suggesting you toss out perfectly good synthetic garments; just that once you try wool, you definitely won't wear them any more.

Wool Grades & Scratchiness

There are 25,400 microns to the inch.

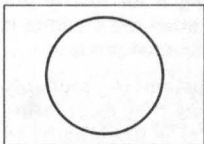

COARSE

28+ microns

Strongest & most durable. Good for lumberjackwear & carpets & blankets that don't go next to your skin.

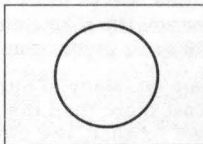

MEDIUM

23-27 microns

For outwear like Pendleton shirts and sweaters. Some guys can wear this on skin, easy, but few women can.

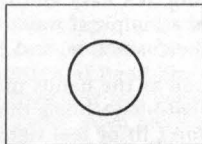

FINE

20-22 microns

Great for outerwear, but guys can wear it next to their skin, and just about all women can, too. Soft.

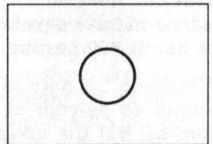

SUPERFINE

17.5-19 microns

"Girl's wool," but guys like it too. Skinny, flexible fibers don't poke. It won't bother anybody, ever.

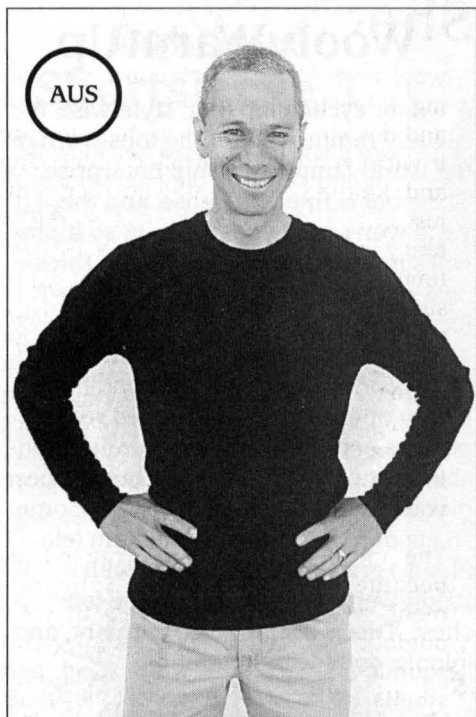

Australian Blacky-T

If you can come up with \$48 for this wool T-shirt, you'll be glad about it later. It's fantastic, and you'll get tons of use out of it.

It's superfine (18.5 micron) merino wool in an interlock knit, which means it still won't hardly wrinkle. As a cycling garment, you can wear it under, over, or instead of a jersey. It's thin and light for layering. Off the bike, you'll wear it under normal shirts, under cotton sweatshirts, and then at the end of the day, you'll strip those off and leave this on to sleep in. You'll rue all the days you've already spent without one.

S: 22-266 M: 22-267 L: 22-268
XL: 22-269 XXL: 22-270

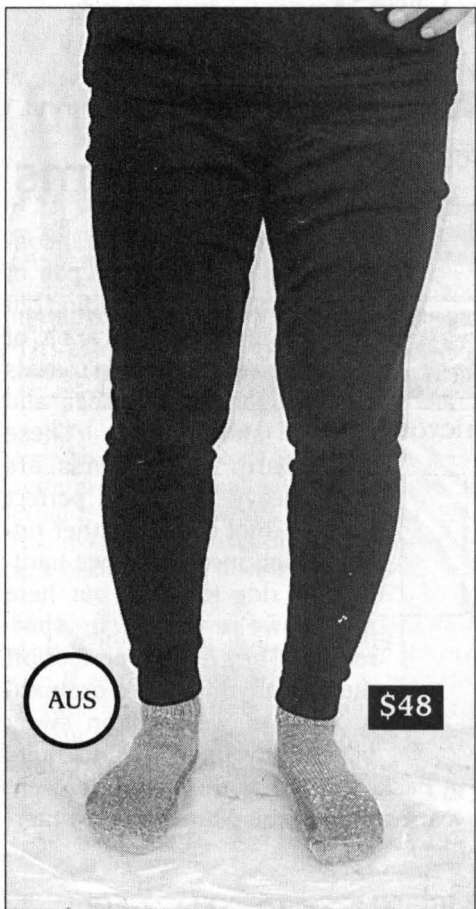

Tights/Long Johns

When it's cold and you know it won't get warmer, tights are what you need. These are not made specifically for riding, but they lack nothing for it, and unlike riding-specific tights, they're great as long johns under regular long pants, or as pajama bottoms. Plus, since they aren't cycling-specific, they don't cost like tights, either.

These are on the light side, as tights go, and that's how we like them. You can wear one or two layers, or wear knee warmers under or on top of them. They're cozy, stretchy, not too snug, and wonderfully comfortable. It'd be hard to imagine not getting your money's worth out of these in just a couple of months of use. A good cool-weather system: Andiamo briefs, then tights, then nylon baggies (\$20+ at outdoorsy stores). It's not the pro look, but it's hard to beat.

M: 22-271 L: 22-272
XL: 22-273

WoolyWarmUp

A winter cycling top that, style-wise, is vaguely reminiscent of the tops worn on the world famous starship Enterprise. The wool is fine and dense, and the wind won't easily penetrate it, so it provides more warmth than its thin thickness suggests. Wear it over a Blacky-T for riding, or a cotton t-shirt if you aren't going to be sweating. Either way, it's a good & useful garment you'll get plenty of use from. Two zipped rear pockets keep your priceless unmentionables out of the hands of all but the best pickpockets. All wool, cut full. It's some shade of royal blue with medium (elephant-) grey collar and cuffs, with WoolyWarm embroiders on the left chest. This is a super nice garment, and it looks good with anything.

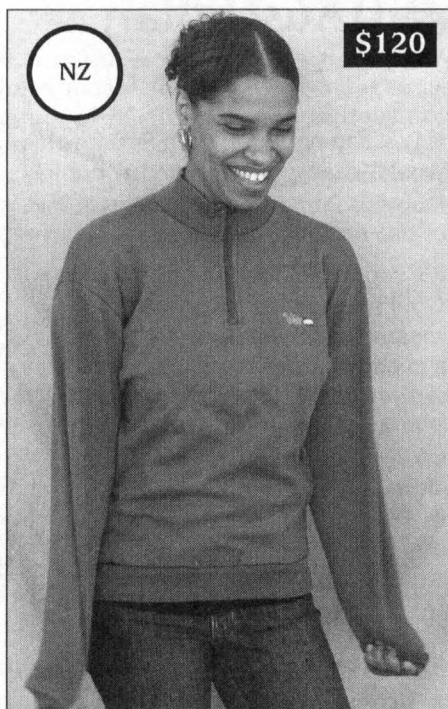

S: 22-358 M: 22-359 L: 22-360 XL: 22-361 XXL: 22-362

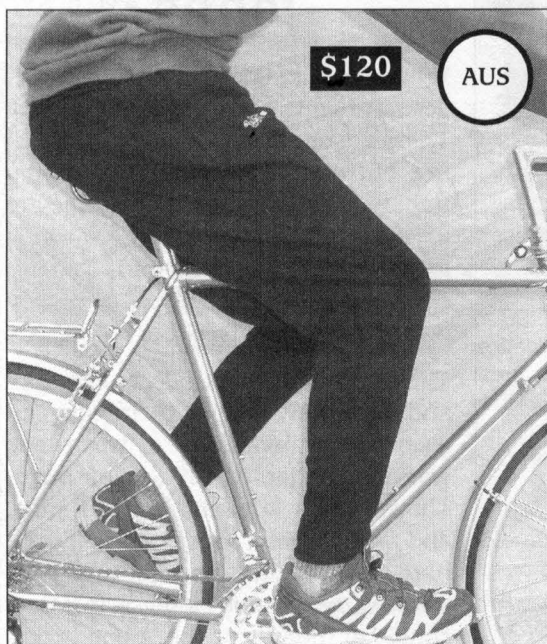

WoolyWarm Cyclebottoms

Few things in life are as incongruous as slipping into a pair of spandex tights, then heading out into the chilly air for a bit of bike. The eskimos don't dress like that for cold weather, and neither should you. These WoolyWarm cyclebottoms are thick, heavy, cozy, and perfect for cold- (not cool-) weather riding, which means that we hardly ever ride in them out here unless we're trying to spot-reduce. They're also perfect off the bike anytime you'd ordinarily want to wear cotton sweat pants, but want to look not quite

so slobbish. Two pockets in front, one in back, tapered at the calf...these are unbeatable for cold-weather riding, and wearing here at the plant, where winter-time temperatures are about 50-degrees. Black.

S: 22-363 M: 22-355 L: 22-356 XL: 22-357 XXL: 22-419

100% Wool Shortsleeve T

All wool and made in Australia by the same people who make our long-sleeved Blacky T, and it's just the same, but with slightly shorter sleeves. If you're not too style conscious and you want a really good versatile system, try this with a sleeveless T over it. That way, if you get too hot, just take off the sleeveless, and you're all set. It's 100 percent merino wool interlock—a costly, but superior knit that feels great and looks good even when it's 3 years old.

If you like loose fits, buy up a size or two.

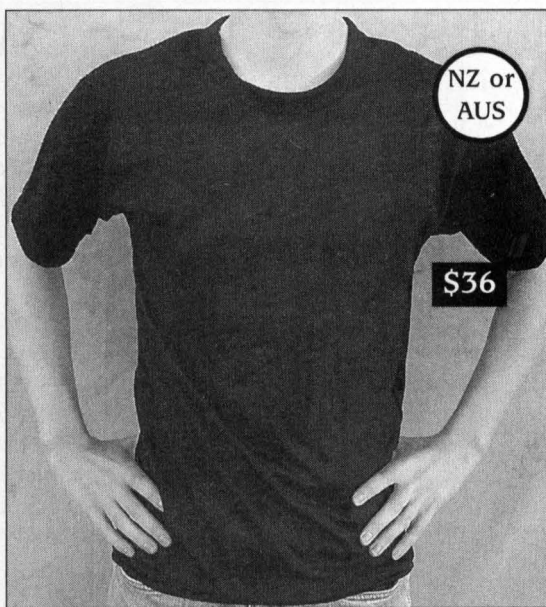

S: 22-421

M: 22-422

L: 22-423

XL: 22-424

XXL: 22-425

100% Wool Sleeveless T

Robert kept cutting the sleeves off of his woolies so he could survive the 100-degree temperatures here in the summer, but it looked ratty, so we had these made. Good in hot weather under a seersucker to keep the chill off during an evening descent; and a fine base layer when the temperature really shrinks. Also good over another wooly t, since it adds a layer of insulation over your chest. That, actually, is a great system. It packs small and weighs little. So bring it on any ride. It's cut too long. Feel free to lop off about 8-inches and use that as a neck warmer. It won't fray.

Black only. Fit is snug by our standard standards. If you're skinny, buy your normal size. If you're normal or stocky, go up a size or two. You know how you like these to fit. I/Grant am 5-10 x 185, and I like XXL, even though I wear a large normal shirt.

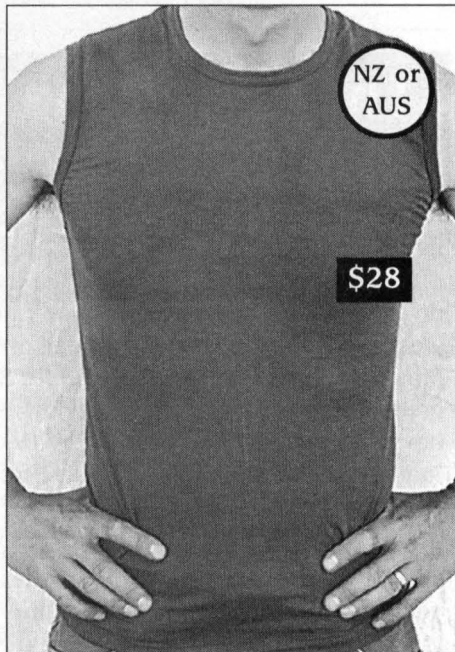

Wash cool, gentle, air dry = won't shrink.
Wash hot, warm dry = shrinks a size.

XS: 22-400

S: 22-343

M: 22-344

L: 22-345

XL: 22-346

XXL: 22-347



\$75

NOR

The Norwegian Record Holder and the most versatile garment we sell

A few years ago on an Arctic expedition, Torry Larsen, the famous (in Norway) explorer wore one of these zip-T necks for 109 days straight without taking it off even once, not even to wash it (it would have frozen). He didn't set out to do that, but it happened. You won't beat that record, but it's a good bet you'll wear yours at least 60 days a year, on and off the bike—that's how useful it is. Most Rivendell employees hit about 80 days. We had these in a nice muddy green couple of years ago, and now they're blue, halfway between royal and navy. They're made in Norway by Devold, and they're a special knit they call "aqueduct" because the inner layer draws all the sweat out to the outer layer, precisely like an aqueduct.

If you already have a green one, you ought to get the blue one so folks won't accuse you of never changing clothes. I wear mine about 80 days a year. If you buy this and try it for a year and don't like it, we'll buy it back from you. Is it good? Yep yep yep.

Men S: 22-392 M: 22-393 L: 22-394 XL: 22-395 XXL: 22-396

Women XS: 22-409 S: 22-410 M: 22-411 L: 22-412 XL: 22-413

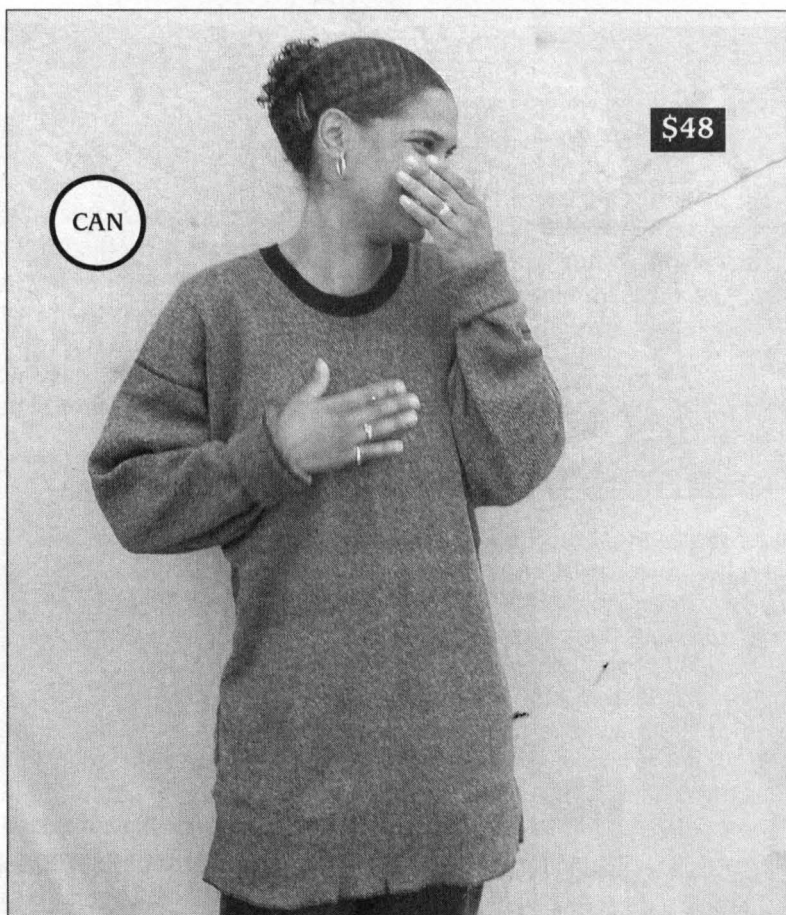

In real life, women wouldn't actually wear this.

Lambswool Sweatshirt

Unlike any other lambswool on earth

It's all lambs wool, not from laboratory-bred cashmere-like little cuties that Macys uses for women's wear, but from wirey little buggers that roam wild in the crags of Scotland, protected from the wolves by their bristly fleece. This lambswool should not go next to your skin (arm skin is okay). But the style, heft, and clinginess is fantastic, and as an inexpensive cold-weather top, it's been a favorite around here for about 8 years. We offer it about every three years, and now it's time again.

Wear it over another shirt, and the scratchiness isn't an issue. The vertical rib knit clings nicely without making you feel fat. The mottled dark grey has the look of coal miner's underwear, and the long body and arms make you think, "Holy cow, who'd they make this for?" It's cheap enough that you can cut off the arms and make a crew-neck vest, and all in all, this is a useful garment, and deserves a spot in your wooly wardrobe. Cut full.

M: 22-281

L: 22-282

XL: 22-283

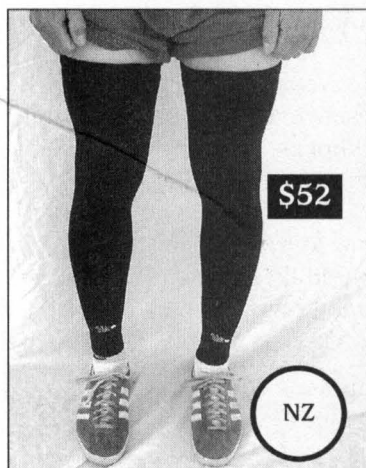

Leg Warmers

Every cyclist needs a pair, because there are so many times when the weather is iffy and changeable and right in between. Ours are the best ones out there, made for us in New Zealand, of 100 percent fine merino wool, with leg grippers so then don't slip too much. They always slip a little; that's just the way it is with leg warmers. They wad up small and stuff away into any handy pocket or bag. Black, easy wash & dry. Wearable with bike shorts or baggies (shown).

S/M: 22-250 L/XL: 22-251



Knee Warmers

These outsell every other piece of wool we have. They're 100-percent superfine merino wool, made just for us either in Australia or New Zealand. They're longer than some knee warmers, and they have grippy elastic to aid in the not-riding down department. If you haven't tried knee warmers and you ride a lot in temperatures between 40°F and 67°F, try them.

They stretch. Guess your size, and it'll be right.

S/M: 22-308 L/XL: 22-309



Arm Warmers

The worst possible look a cyclist can have is arm warmers and a sleeveless T, as shown. But arm warmers with a short-sleeved jersey, or any other non-sleeveless shirt, for that matter, are a good idea. If the air gets too hot, just push them down, and you've got some styling wrist bands capable of soaking up more sweat than you're able to leak out.

Synthetic arm warmers are for hard-core vegans only. Otherwise, why wrap your skin in tight plastic? Our 100-percent wool ones feel better and work better.

S/M: 22-330 L/XL: 22-331

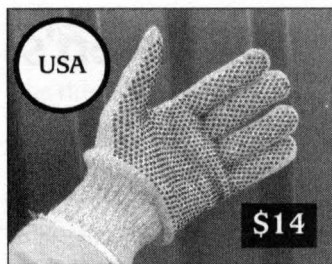

Wool Gloves

Rag wool gloves are low on the glove totem pole of prestigiousness, just above all-poly and all-cotton, but they're the best choice for riding in temperatures between 35°F and 54°F, and that covers a lot of riding. These are 85 percent wool, and have rubbery dots on the palms and fingers for better grip and wear. We've sold these for years now, and

they have such a fantastic function-to-cheap price ratio that it'd be hard to imagine any other glove knocking them off. One size.

Fitzall Wool Glove with Palm Dots For Fantastic Grip: 22-144

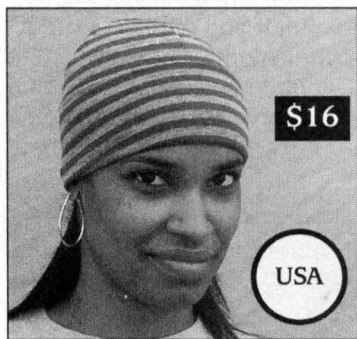

Wooly Beanie

When you go to an outdoorsy store looking for head warmth, you'll find eskimo-themed pretenders, snowflake-patterned phonies, Norwegian reindeer-motifed yuksters, and "classic watch caps" made of acrylic. *This* beanie is 100 percent wool, and perfect in every way. It is thin, not too hot to exercise in, and fits under a helmet. You can pull it down low to cover your ears and forehead, or wear it high and perky.

Double it up for extra warmth. It even makes a good emergency mitten.

This year's color is blue and grey, a combination made just for us. Year after year, this beanie is one of our most popular things. It makes a lovely cheap gift. It's small, packs away anywhere. Wash it before you wear it, to rumple it up some.

Blue & Grey Wooly Beanie! 22-403

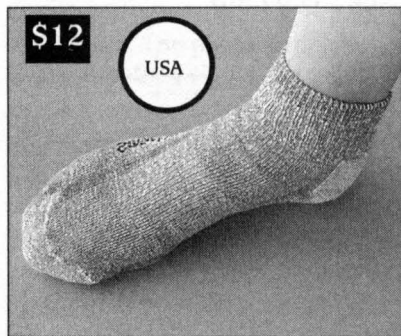

Best Bike Sock In World!

There are lots of bike socks out there, but this is the only one you actually need, and if you have a pair of these and tons of the others, you won't wear the others. These are actually SmartWool light hiker sox, and as riding socks, they're unimprovable. They're 75 percent wool, and the part that contacts your skin is 100 percent wool.

M: 22-152 L: 22-153 XL: 22-154

Wool Care Is Easy

Wash it on gentle cycle with Ivory detergent, Soapworks soap (Trader Joe's has it, and probably they aren't the only ones), or in the shower with shampoo. After the spin cycle (or rolling it in a towel and stepping on it), let it air dry and it's ready the next day. Wool undershirts can go ten or more wearings between washings. It's good to alternate undershirts, so have more than one.

Ultimately you'll get a few holes, from something. The holes rule out future fancy use, but don't make any difference as bike wear. Wool is a durable fiber. It's strong, and ages well. Wear it hard, wear it constantly, and enjoy it.



Wigwam Women's Socks

These are for women or guys with size 9s or smaller who are okay with wearing women's socks. They are the sox my wife and oldest daughter lounge around in and wear on cold days. Wearable inside out or inside in. They're the most comfortable and luxurious wooly sox we've seen, and they ought to make bigger ones and not call them women's socks. Eighty-five percent wool. If you don't like these, we'll double your money back.

Greyish Green: 22-389 Lightish Blue: 22-299 Light Greyish: 22-300

Andiamos

These slightly cushy feather-weight skivvies are great under non-cycling pants or real cycling pants. They provide a seamless area and slight padding, and they dry super fast.

Men's White, Women's Black. It's handy to have two pair.

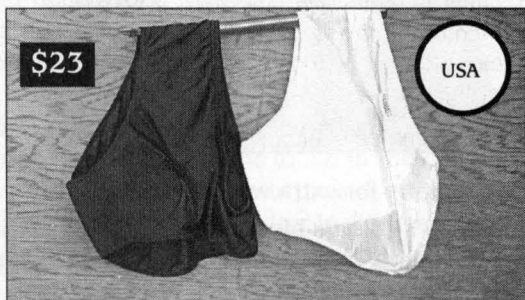

MEN'S: M: 22-301 L: 22-302 XL: 22-303

WOMEN'S: S: 22-305 M: 22-306 L: 22-307

Suspenders

Walter sews these in San Francisco, California. They're a well made bargain for \$10.

Suspenders are especially good when you aren't wearing ultra-snug spandex. Pedaling in a riding position tends to pull your pants down, and you don't want a belt there, so suspenders are the answer.

Red X-back, for maximum security; Blue Y-back, for ease of use and that "wedgie" feel. These are so good and so cheap that you should buy both, so when you get your third pair, you'll know which you prefer. Elasticified, so one size fits folks from 5-feet-1 to 6-feet-6.



Red X-back: 22-390

Blue Y-back: 22-391

Bell Metro

The things we like about it:

1. It's round. Round looks good, rather low-key compared to most helmets.
2. It has no tail. This is related to roundness, but another good thing about it is that since it has no tail, it's safer in an accident, because there's less chance the helmet will catch on something and snap your neck around.
3. It's grey, although Bell calls it "titanium." It doesn't dominate color photos the way brighter helmets do.
4. Quiet graphics. No fades or two-color sections or other attempt to make it look "fast & exciting."
5. A red light clips on. It doesn't come with one, but we sell it separately, and it's a good spot for a light.
6. It's less obvious on your head than some helmets. It doesn't stick out much.

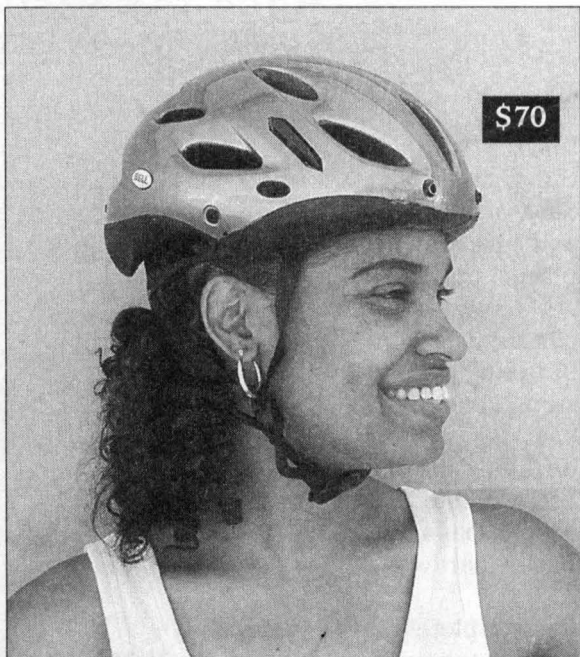

Bell has built a whole line of add-ons for this helmet—wind-blockers, ear warmers, rain cover, visor (included but not shown), and mirror. All those things have their place, but it's enough already that we're selling a helmet at all. Last year our insurance carrier wouldn't allow it, but that was fine, since there was no helmet we were eager to carry, anyway. If you wear a helmet, the Metro is a good choice. We offer it because many bike shops don't. Bell makes it in red, blue, black, whitish, and this color (see description above). The photo sample is grey (discontinued). But the titanium color is close to it. Medium fits to 7 3/8. Large fits 7 3/8 to 7 3/4. The LED fits the helmets, pockets, etc.

MED: 31-426 LARGE: 31-427

Light (\$8): 31-385 Winter Kit (\$20): 31-428 Visor Mirror (\$8): 31-429

Ride as if your brain is in a flimsy sack (fs)

Helmets don't guarantee safety, and it's with mixed feelings that we even offer one. Most of us here wear one almost always. Whether you wear one or not is up to you, but if you do wear one, pretend it's not there. If you wear one with the idea that now you're safe, you may be in more danger than you'd be without it—because the feeling of safety tends to make people compensate, and take more chances. This phenomenon is called "risk compensation," and it is common in downhill skiing, rock climbing, and other sports where protective gear is common.

Bags for Bicyclers

An old approach makes superior sacks.

The obvious and most important function of a bag is to carry something, protect it, and allow you to have at it without a lot of hassle, and nylon does that well. Today's plastic, one-touch hardware is fast and convenient and clever; you can't argue that. But once you get a step past the basics, there's nothing there to actually like about nylon bags with plastic hardware.

It's completely different when the bag is made with the best quality natural materials and metal. A bag like that feels good to get your hands on, makes you want to go places, and is the kind of thing you want to keep forever.

Baggins bags aren't the last word in luggage, but they are hard to beat as bike bags. They look nice because they're made with waxed cotton, brass, and leather. They last because they're well-made. They're a pleasure to use because they're well-designed.

Baggins designs are simple, because simple bags are easier to use and less confusing when you're packing or unpacking hurriedly or in the dark, or in the rain, or any nasty combination of those things. You want to know *if it's here at all, that flashlight's got to be in pouch A or pocket B, not which the heck pocket is the flashlight in?*

Packing for the return trip is usual-

ly harder than packing for the outbound, because you just aren't as fastidious about folding, rolling, and stuffing as you were before you left. On your way back, things are dirty, wet, and you may be dealing with them in an altered and bulkier state; so being able to pack by cramming was high on the list of features we worked into the Baggins line.



We went all over looking for the right fabric and hardware, and settled on a 15 to 16oz waxed cotton fabric, supplied by Herbert Rice. The buckles are brass. The leather is fine, and the workmanship is top-notch.

We can't guarantee this year's Hobo bag will be a perfect cosmetic match for next year's Hoss. The materials are purchased in small (affordable) quantities, and that combined with natural variations in, yes, dye lots, means we've got to be flexible. The alternative is being our vendors' worst nightmare customers, and we don't want to do that at all.

Too bad this catalogue is in black and white, because these Baggins bags are a really nice, but hard-to-describe shade of greenish khaki. They're close to the color of a slug, but if that doesn't bring up any images to you, look online. We'll have more photos of them there, anyway.

—GP



\$78

USA

Baggins Banana Bag

The Best Fair-Weather Day Bag in the Galaxy

Modeled after a certain French bag, but enlarged, improved upon, and more rugged, it is shaped roughly like a fat banana or paisley, wider at the top than at the bottom. You can pack it any way you like, and it always seems right. The top closes with a brass roller buckle, and opens upward, so the load stays in place while you're digging around in it. The wide-mouth makes it easy to find what you're looking for, and even if you do have to take everything out to get at something down low, it's easy to pack back up, mainly because there's no zipper to fight with.

Member and professor Benson Tongue mounts one on the front of his handlebars, around the stem. There it serves as a camera bag, suitable for anything up to a small 35mm camera and a zoom lens.

The Baggins Banana is the best small seat bag you'll ever use, and by far our most popular model. We sell about 300 of them per year (one year, 444). It's a good one!

What Fits In It?

Two inner tubes, a small tool kit, a light shirt or windbreaker, two sandwiches, keys, and that's about it. Its 175-cubic-inch capacity is roughly equivalent to a 5.6-inch cube—big enough to keep you fed and warm and prepared in a spartan sort of way. And, in case you were wondering, it really is the only seat bag of its size that actually can carry bananas without crushing them. They stick out the sides, and you can get at them while riding. You just reach back and grab for them. If what you grab feels like a banana, it most likely is one.

The top flap has straps through which to lace cord or elastic or straps, for adding on extra gear. A sleeve pocket in the back holds your wallet. Plastic stiffeners in the front and back add shape when the bag is empty, but don't contribute much otherwise, so feel free to take them out. The Banana Bag mounts easily onto any saddle with rails, and is built to last.

Banana Bag: 20-082

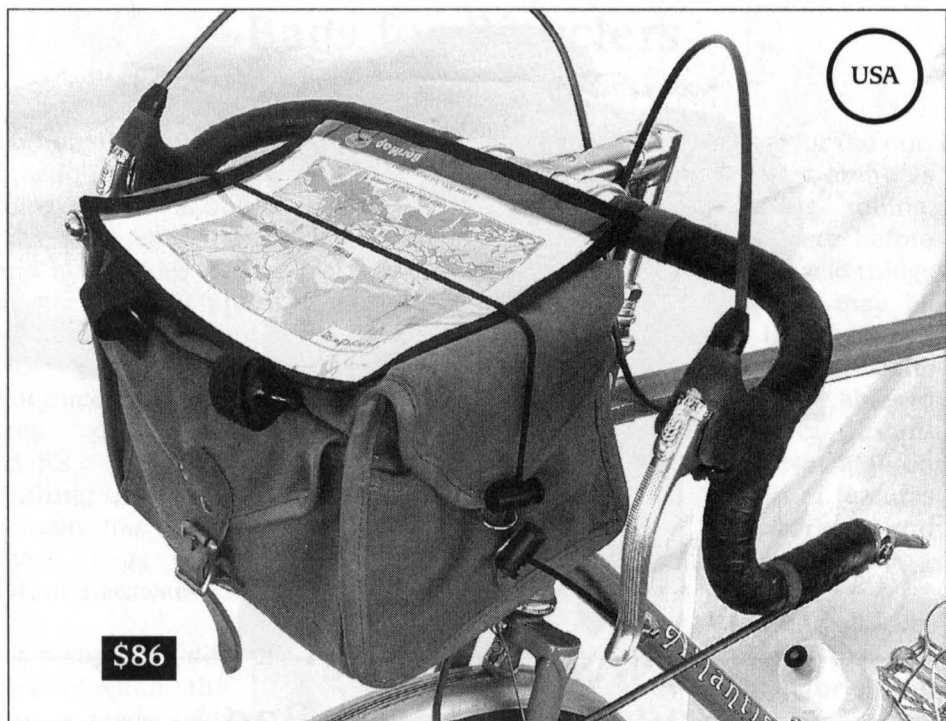

Baggins Boxy Bag

Handlebar bags are a delight on any long ride, and this is the best one we've used. It has a main compartment, three internal sleeve-like pockets, two external side pockets, and one front buckled pocket.

The lid is tailored so that you get full coverage of your load even without it cinched down. In fact, probably the only time you'll want to fully batten down the hatches is during a strong wind or rain; or if you've got a Leica in there and you're bouncing down the trail.

It comes with a Cyco-Active map case, which velcros onto some D-rings and is held down by a shock cord, which also holds down the flaps of the side pockets.

Like all Baggins bags, it is made of cotton duck, leather, and brass. The seams are made with leather cording, which is by far the most expensive but best way to make a seam. On a bag such as this, it's probably overkill, and certainly was a main reason why it ended up costing almost a hundred dollars. But if you're looking for a wonderful handlebar bag you can buy just once and enjoy for a long time, this is it.

This bag requires the \$46 rack, below. The combination is expensive—\$132—but it is the most convenient, easy-to-use handlebar bag we've tried.

Boxy Bag: 20-083

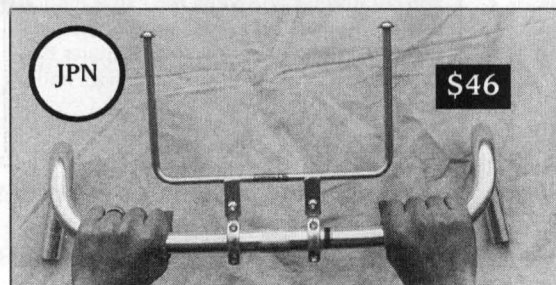

Boxy Bag Rack!

For the Baggins or Carradice Boxy bags. Stupendously made by Nitto, clamps on any Road H'bar, holds securely, doesn't scratch. Nickel-plated tubular CrMo.

Boxy Bag Rack: 20-031

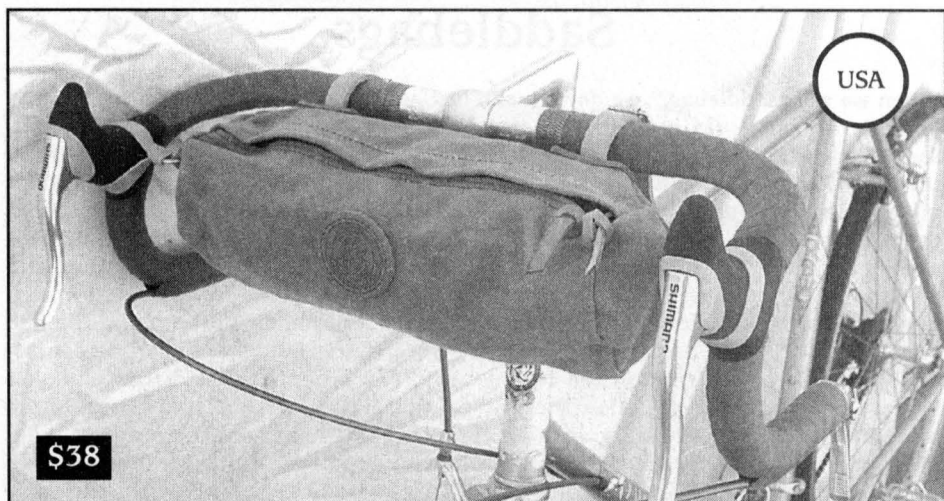

There are different ways to suspend the Candy Bar Bag to minimize swinging, and none are tricky. You can tie the D-rings under the brake lever hoods if you're a neatnick, or tie them outside them or directly to the lower portion of the drops if you aren't. You can't do it wrong!

Baggins Candy Bar Bag

The lightest, smallest bar bag out there. It's easy to mount, and carries enough candy bars for a long day ride, with room left over for gloves, wallet, keys, pocket camera and another thin layer. This basic design originated in the '70s in America, so naturally it's not very stylish, but our classed-up version goes well on any bike and improves its look, too. It's a muddy khaki color with thick leather trim and a real brass zipper with a two-way slider. Strap it onto the bar, loop some loops over the brake levers, and you're all set, and what's more, you'll probably never take it off. Instructions included.

Candy Bar Bag: 20-085

Our \$3 Burrito Wrap

Half the cost of a fancy burrito, and it'll last 20 years.

For those of you who think all our other bags are too big, and are currently using some kind of black ballistic nylon micro-wedge pack—well, this is better and cheaper. It's an 18 x 18-inch square of unhemmed waxed and waterproofed heavy cotton duck.

When you flat, lay it out on the ground like a place mat. All your tools are there, and won't get lost. When you're finished, just wrap them up again, like rolling up a burrito, and secure it to your seat rails or seat stays, using a toe strap couldn't be simpler, lighter, or cheaper. It's only \$3, and it'll last 30 years.

Burrito Wrap: 20-003

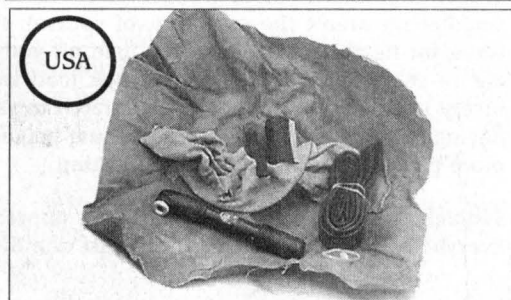
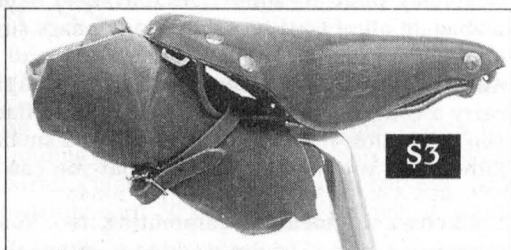

Saddlebags

When we say “saddlebag,” we don’t mean just any old seat bag. Rather, the sideways or *transverse* style (as proper linguists call them) shown on the following pages. Saddlebags were the favored way to carry small to middle-sized loads in England from the mid-’30s to about the late ’70s. America wasn’t much for sport-cycling until the mid-’70s, so it’s not as though we Americans rejected them; we just didn’t know about them. Italian cyclists and cycle makers have always been focused on racing, and since saddlebags aren’t part of the racing scene, you could have been born, grown up, and died in Italy without ever having seen a saddlebag. The French were more well-rounded, cycling-wise, and certainly made nice panniers and handlebar bags and the odd seat bag (our Banana Bag has French roots). But historically the French have considered themselves the center of the cycling world and superior to everybody else, and so have been reluctant to follow the ways of the outside world. The British, on the other hand, are generally not known for their fancy style, and so it’s no surprise that the homely, transverse saddlebag was developed in England. It may be impossible to put an exact date on it, but Carradice was making them in 1932, and during the quarter century between 1945 and 1970, saddlebags adorned probably 40 percent of the lightweight, roam-around-the-countryside bikes there.

In America now, we have a small but powerful racing influence. There aren’t many actual racers, but racing style and equipment casts a wide net that traps fitness riders, new cyclists, weekend warriors, and general enthusiasts who figure, incorrectly, that the equipment developed for racing is naturally good for everything. Real racers don’t carry anything. Racer-types carry as little as possible. In these parts, you see them overdressed for the six to 11-mile climbs, because there’s no place to store the wind shell they’ll need for the descent. At the top, they huddle and shiver in their spandex and polyethylene, sucking gels because they couldn’t carry real food, and dreading the descent because they couldn’t carry cozy insulation (which they didn’t want to wear on the climb).

That’s where a saddlebag comes in handy. It holds more than you could ever stuff into your jersey pockets, and isn’t as picky about the shape or goopiness. It lets you prepare for the weather, instead of being at its mercy, and turns long, nervous rides in iffy weather into carefree, sightseeing cruises. A bike without a saddlebag just isn’t living up to its potential. Once you try one, you’ll see why so many riders are nuts for them.

Obviously, there are some rides that don’t require much gear, so you don’t need a saddlebag on all of your bikes. But saddlebags sure are nice to have on longer rides, and unfamiliar rides, and cold-weather rides, and group rides, and exploratory ones, too. And the larger saddlebags are ideal for camping. In one of our larger bags, you can carry a compact pad, bag, tent, tarp, food, flashlight, book, beanie, and knife. Unless you’re an ultra-minimalist, you’ll want a small handlebar bag to carry some spillover. Either way, you’ll be amazed at what you can do without full panniers.

Saddlebags are ideal for commuting, too. You can carry gear in a day pack or messenger bag, and if you’re wedded to either there’s no sense talking you out of them (saddlebags aren’t the only way, of course). But here again, if you’re open to other ways, for heaven’s sake, take the load off your back and shoulders with a saddlebag. My 14-year-old daughter’s daily book load weighs in at around 16 pounds, and fits nicely in her Hoss. It would be a stretch to say she’s the envy of her schoolmates—having her own Hoss and all—but it sure makes the 25-minute ride to and from school more pleasant, and that’s no small thing.

Saddlebags will change your whole approach to carrying medium-sized loads. Everybody should have one on at least one bicycle. —GP



This Hoss is neatly packed, but not nearly to capacity. The Hoss easily accommodates all you need for at least overnight in winter or two days in summer; and combined with a decent sized handlebar bag or a small front bag of some kind, you'll be able to go anywhere for a week.

HOSS

For Weekend Tours, Overnights, and Bulky Commute Loads

The Hoss is about as big as a saddlebag can get, and ought to be your choice for overnights or any kind of touring or commuting when the load is less than humongous and you don't want to carry panniers. It carries a big and heavy load amazingly well, and once you get over the initial feeling of pedaling with 20 pounds in a saddlebag, you'll soon forget it's even on there.

The Hoss (like the Adam) has riveted straps on its underside, which let you easily strap it to a rear saddlebag support or rear rack, to stabilize a big load (like two gallons of milk and ten apples). Supplemented with a Hobo or Boxy bag up front, you'll be able to carry at least four days' worth of camping gear—for a lot less money and weight than racks and rear panniers.

This is a stunning bag. It isn't boutiquey in the Dourney & Bourke or Ghurka sense, but is a bit more refined than a Carradice, and that's why it costs so much. If you want the finest huge-capacity saddlebag made, this is it.

THE BAGGINS HOSS: 20-078



ADAM

When Hoss is Too Big, But You Still Need To Carry a Lot

The ADAM is our most popular big bag, because our claims about the Hoss's hugeness tend to scare folks off. ADAM isn't that much smaller, and a case could be made that we don't need both, but the brothers theme sort of carried us along, and here it is. For anything other than camping and pannier-substitution, you're unlikely to max out the capacity of the ADAM. And if you do, you can always tie extra gear on top, using the handy rings that are sewn onto the flap. If you can get only one saddlebag, this is the size to get.

THE BAGGINS ADAM: 20-079

Saddlebag Support, or No?

Three years ago, an older fellow who came from England wrote me a letter in which he maintained that it wasn't even proper to carry a saddlebag without a support; and he was scolding me for not pointing that out.

Older and English notwithstanding, I don't buy that, but certainly when you leaf through the old British bike parts catalogues, there are all kinds of saddlebag supports listed, and it at least makes you think.

Saddlebag supports stabilize your load and prevent it from sagging due to pure weight or lousy loading. For commute-sized loads they aren't necessary, but for camping loads or anything super heavy, saddlebag supports are worth their weight and cost. We've used several different styles, and there's no single clear winner. The one we have, made to our specs by Nitto, works as well as any, and better than lots of them. —GP

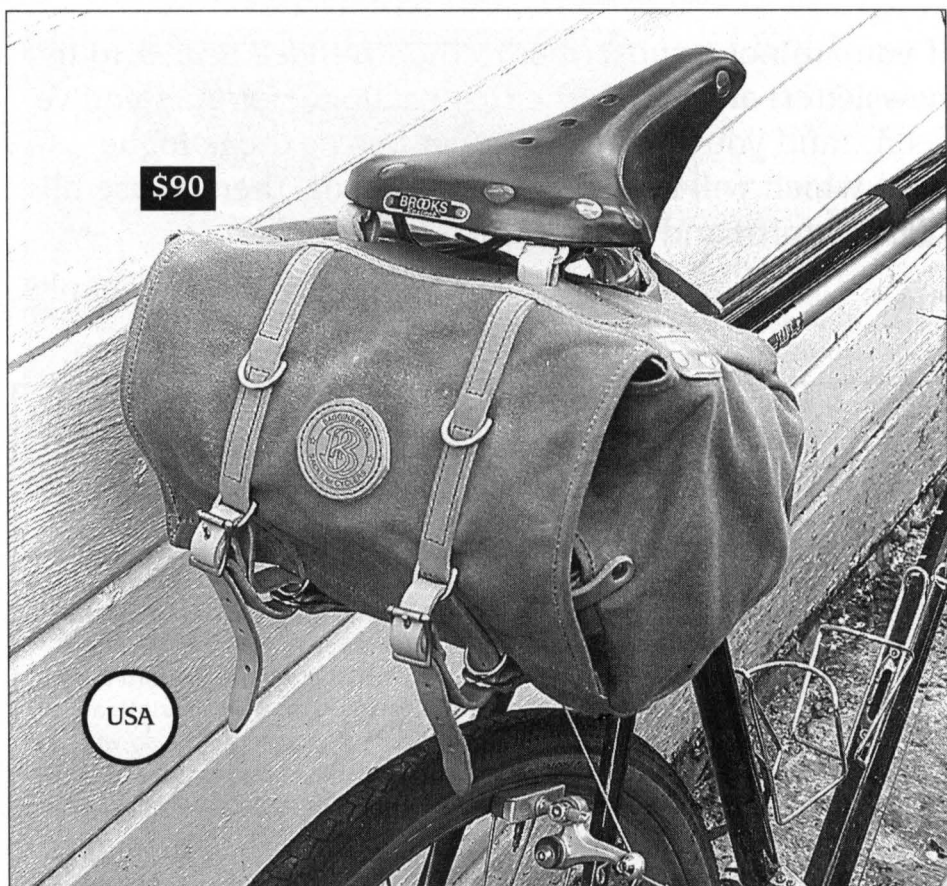

LITTLE JOE

When Banana's too small, and Adam's too big. Our most popular model.

This has become our most popular model, surpassing even the now-legendary (in these parts) Banana Bag. It holds all you'll need for a multi-hour ride in iffy weather with uncertain food-buying opportunities. And it's small enough to leave on all the time, even if all you're carrying is a patch kit.

Two sleeve pockets inside let you separate your wallet, pocket camera, and tools from the main load. Our new support system with grommets and laces assures no tire rubbing, and no spilling the load out the back, even if you forget to buckle down the flap. Plenty of tie-on points let you carry the occasional weird-shaped goody, or expand the Little Joe's use to include record-setting overnight camping minimalism. All in all, the Little Joe is a lovely bag, a jewel in canvas, brass, and thickish leather.

THE BAGGINS LITTLE JOE: 20-080

Caring For Your Saddlebag

All our saddlebags are rugged and made with good materials that can handle a certain amount of abuse, but to get the maximum life out of one, goop up the leather as soon as you get it. The Obenauf's we sell is as good and maybe better than anything out there, so smear a coat on all the leather surfaces first thing, and maybe once a year thereafter.

If you are not a subscriber to the *Rivendell Reader* (our newsletter) and this is the first catalogue of ours you've seen...and you would like to get our next catalogue also, which will be better than this one, then please fill out this form and mail or fax it back to us.

Thanks.

Name _____

Address _____ City _____ St _____

Zip _____

Where did you get this catalogue? It seems like an unnecessary question, and we'll send you a catalogue whether you answer or not, but the fact is, we're a small company with high printing costs, and we can't afford to print tens of thousands of catalogues and distribute them indiscriminately at any ride or event that is remotely related to outdoor activities, so we try to be selective. And by telling us where you got the catalogue, we learn whether or not it was worth it to pay to get them distributed at that charity ride, swap meet, or whatever. So how about it—where did you get this?

I got it.....

Mail this to:

Rivendell Bicycle Works QQQ

Box 5289

Walnut Creek, CA 94596

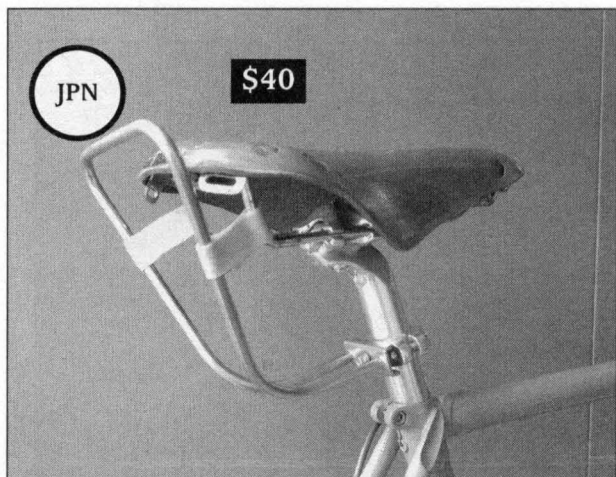

Uplift

This rack lifts your saddlebag up a bit, which is never a terrible thing, and is a necessary thing when your saddle is low and the bag otherwise drags on the tire. A saddlebag support such as the one below also prevents the tire from rubbing, but this Uplift does it with less material, weight, and cost. See how the Uplift is taped to the rails of the saddle? You must do this, to intercept the load. If you don't, the load will leverage

the seat post clamp, and ultimately the rack will break there. This is not a design flaw, it is just Proper Use. This is a terrific and useful little rack, and works splendidly with any saddle bag we've ever made, carried, used, or seen. Made just for us by Nitto, of tubular CrMo and aluminum.

Uplift: 20-036

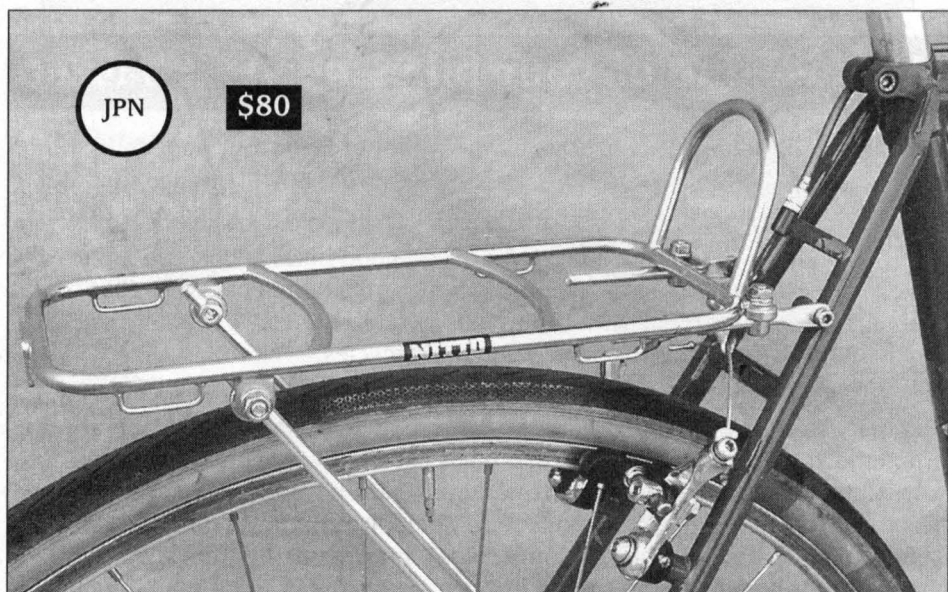

Saddlebag Support

Another clever and beautiful Nitto rack made just for us. It's a smallish rear rack for smallish loads (tie a stuffsack full of clothing and food on top of it, for instance), or a saddlebag support, to keep a big saddlebag on a small to medium-sized bike from dragging on a fenderless tire. It's perfect for a basket, too. It's a cinch to mount on any halfway normal bike—to upper connector rods attach to the seat stays, either directly to rack braze-ons, or around the seat stays using the included clamps. Similar clamps attach the two lower rods to the seat stays, assuming you don't have rack mounts down low, and that's what we call a safe assumption. Once on, it's secure and lovely, and there's no reason to ever take it off.

Saddlebag Support/Mini Rear: 20-095



At least one of your bikes needs a basket

To suave modern bicyclers, baskets are a symbol of low-brow, poor-folks, non-serious riding, and there's nothing we can say here that will change that. But we're in love with baskets, and if that makes us unsuave, nothing new there.

One reason front baskets haven't taken off on good bikes is because, up to now, they've been designed for bikes with high-rise handlebars and coaster brakes. They've interfered with cables, and few are the views that bug one as much as sharp bends in fine cables on good bicycles.

Wald, an American bicycle part maker since 1905, and in the same location in Kentucky since the 1920s, has a new basket that solves all basket/cable routing problems. It works great with normal bikes except those with STI shifters, but something tells me that wasn't the market. I/Grant have used a basket almost every day for the past year, and am sold. There are still times when I prefer saddlebags—in bad weather, on longer rides, for organizing things. But for short errands or commutes when I just want to throw in some mail, lunch, books, and extra clothing, a basket is hard to beat.

You need a cover, or things will fly out, so we offer a net, too. It's a good system. You can see inside it, and if something soft like a beanie or gloves are down at the bottom, you can fish them out through the holes.

Rear baskets mount on top of rear racks. Tall rear baskets get in the way when you mount and dismount, so we found a shallow one, which carries lots and doesn't get in the way.

Give baskets a try. It is amazing, when you think about it, that baskets of this quality can be made in the United States, and sell for so little. The process must be quite automated, or else somebody's not getting paid enough.



Wald Front

This is the newest basket on the block, and if I were a front basket designer working on competing designs, I'd tip my hat to Wald, then quietly walk into the mountains, and that would be that. The bracket mounts easily on drop or Albatross or straight handlebars. The basket itself lifts on and off in two seconds, and locks securely. It's genius. Powdercoated black, and the welds are so smooth you can carry water balloons. They make it in white too, but it looks

too cheap. Two sizes: Small and Big. For drop bars narrower than 46cm, get Small. Otherwise, the size is up to you. If you buy both, you can trade out baskets on different bikes, according to whatchagonna carry. *Hallelujah!*

Small is 9" front-t-back x 12" wide x 8" deep & 2.32lb (light, for what it'll tote!).

Big is 9.5" front-t-back x 14.75" wide x 9" deep & 2.75lb (and it carries a lot).

small: 20-098

BIG: 20-097

Wald Rear

Le challenge: A decent-capacity rear basket that didn't overly interfere during mounts and dismounts. Something not too heavy when it's empty. Something that mounts on just about any rear rack. Something made in our own Kentucky.

Le solutione: This guy here. It comes with clips that you may or may not use to secure it to a rack. If you don't use the clips, you'll have to use something else—zip ties, tie-wire, or some kind of something else you get at the hardware store. This is a nice basket. It measures 9.95" x 15" x 4.75" and weighs 1.14lb. Black or Silver.

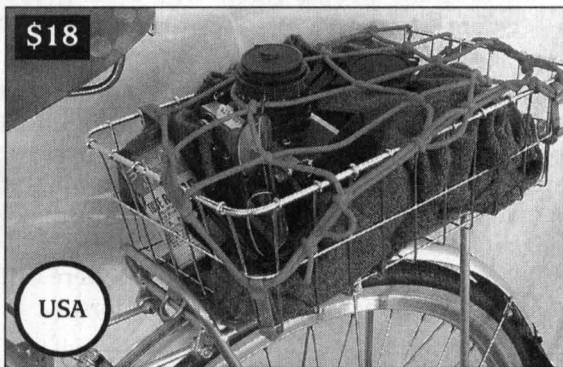

High Tech Black: 20-101: \$18

High-Oh Silver: 20-102: \$18

Red Basket Net

Don't get a basket without getting this, unless you like losing your load. Made of stretchy cord and shaped to fit a basket top. It stays on with plastic hooks, allows access through the mesh, and weighs nothing. Tip: If you rig it right, you can tie or tape two of the corners to the basket, and just use one hook. We assume it's made in Shanghai, but haven't asked.

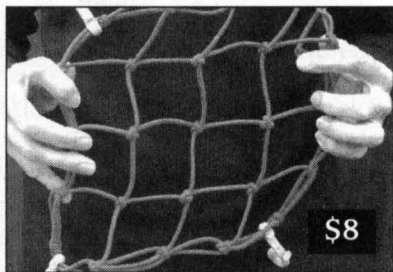

Le Net Rouge (Red): 20-099

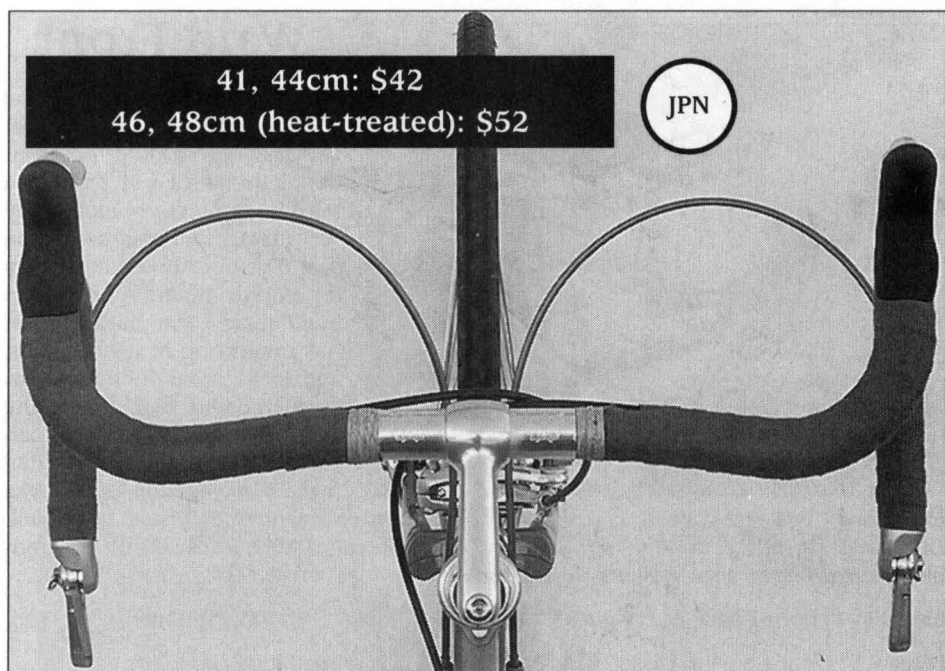

Nitto Noodle Bar

The drop bar people riders who already like drops will go nuts over, and riders who don't like drops right now will actually be able to stand.

Subtle details that are barely noticeable to the bare eyeball make this handlebar special, and in all likelihood the most comfortable drop bar you'll ever set your paws on. The top portion sweeps back toward you slightly, bringing the bar closer; and the drops (lower portion) flare out four degrees, but the main thing is the ramp. That's the portion of the bar immediately behind where the brake lever fits, and the reason the ramp is so important is that you put your hands there a lot. If it's too steep, the support isn't there and your hands slide forward and down. To keep them there requires effort.

On most bars the ramp is about 24 to 32 degrees, which is fine. But on the Noodle Bar, it's a much flatter 15 degrees, which means your hands stay put and are well-supported. You don't need to hold on to stop sliding forward. Your wrist doesn't have to bend around the curve of the bar. Then on top of that, when you rotate the bars up about 10 degrees (normal and proper with any drop bar), that 15 degrees turns into five degrees, and that's just heaven.

This has become our most popular drop bar, and some folks grumble that now they have to get one on all of their bikes. There are worse ways to spend loot. It feels normal and natural immediately.

If you're debating between two sizes, consider that a wider bar offers more leverage, so you can more easily hold the bike as your legs (which are much stronger than your arms) push on the pedals and tilt the bike.

41cm: 16-111

44cm: 16-112

46cm: 16-113

48cm: 16-128

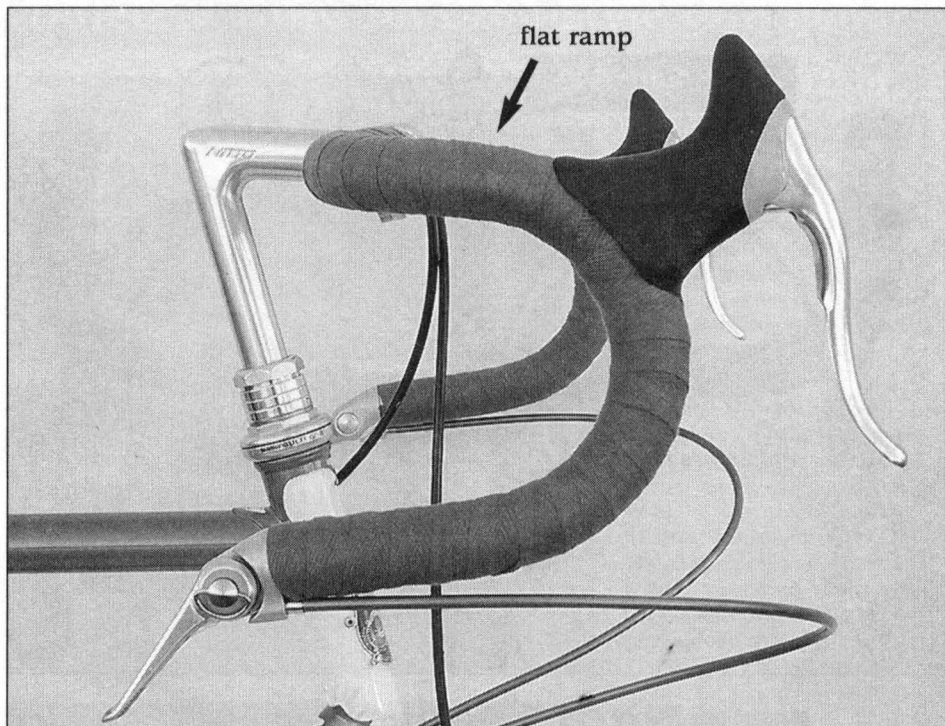

You can clearly see the flat ramp behind the brake lever. Your hand rests there with no tendency to slide forward. On an unrelated note, Keen-Eyed Folk will notice that we didn't wrap the shifter cables under the tape. Sometimes we do, sometimes we don't, but with indexable housing, it's not necessary. It's stiff, doesn't flop. And not having the housing under the tape makes it easier to change shifters later. Not that you'd ever want to with these Silver bar-enders, but if you start off with something else, you know, you might.

Noodle Bar Specifications

Material: Aluminum (5056)

Finish: Satin

Width: 41, 44, 46, 48cm

Reach: About 91mm

Drop: 140mm

Weight: 331g; 343g; 374g; 385g

Flare: 4 degrees

Clamp Ø: 26mm

Bar OD: 23.8mm

Shifter compatibility: Road style.

Recommended use: Road, touring, commuting. The 46 and 48 cm heat-treated ones are made with a super-strong, heat-treated aluminum.

You're unlikely to break any of these bars, but Nitto, a conservative maker when it comes to safety, likes it when we say the non-heat-treated models are for roads only.

Can a Handlebar Absorb Shock and Give You a More Comfortable Ride?

Of course not. Some bar makers claim that, but don't believe it. An aluminum or carbon fiber handlebar that flexed enough to contribute that way would fail in short order.

All you want out of your bar is a safe, comfortable perch at a reasonable weight, and enough stiffness to control the bike and not have it feel funny because the bars are flexing too much. *And strength, for safety.*

Comfort comes from body position and weight distribution first; tire pressure and wheel base second; and everything else is so far behind as to not warrant a mention. Get strong, safe, and beautiful handlebars!

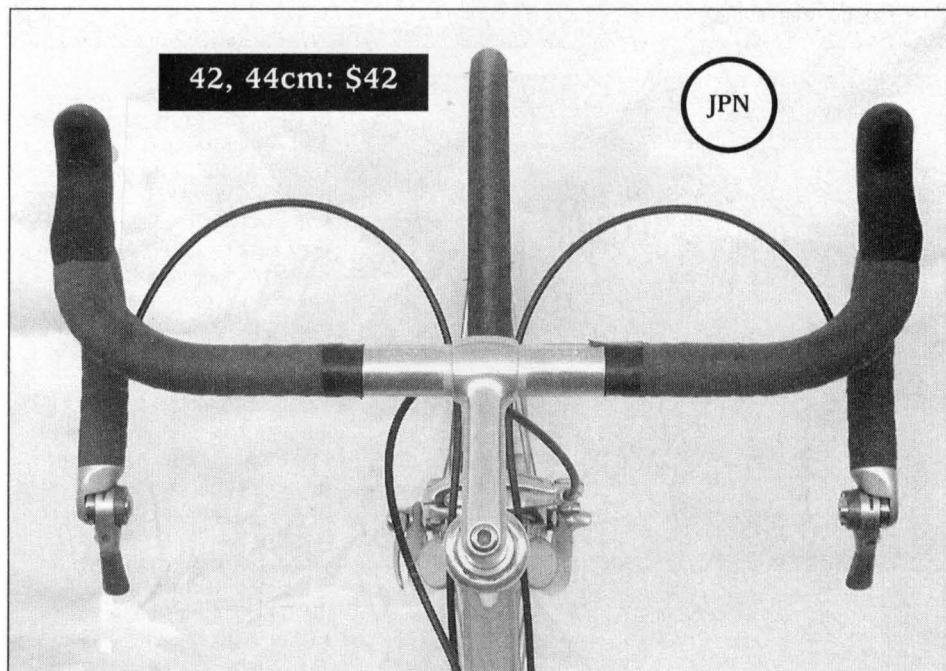

Nitto Dream Bar

Our traditionally shaped drop bar for those who think “noodle bar” sounds goofy

As shocking as it is for me (Grant) to find that somebody wants a drop bar and doesn't want the Noodle, that sometimes does happen, and this is the perfect bail-out. It's a traditional shape, with no super-flat-tish ramp (it's 23-degrees, compared to the Noodle's 15-degrees), no swept-back top section (the Noodle's comes back 15 degrees), and a mere 1-degree flare-out at the drops (Noodle: 4°). The reach and drop are about the same as the Noodles—91mm and 140mm respectively. If you don't buy in to the benefits of a flat ramp and a slight flare, or if you're new here and think “Noodle” sounds scarily undignified, then go for this one. Available in two widths only, our thoughts being that if you're that traditionalistic, you probably wouldn't go for a wide bar, either.

42cm: 16-081

44cm: 16-082

Dream Bar Specifications

Material: Aluminum (5056)

Finish: Satin

Width: 41, 44, 46, 48cm

Reach: About 91mm

Drop: 140mm

Weight: 42: 331g; 44: 343g;

Flare: 1 degree

Clamp Ø: 26mm

Bar OD: 23.8mm

Shifter compatibility: Road style.

Recommended use: Road, touring, commuting. The 46cm heat-treated one is made with a superstrong, heat-treated aluminum, so it's stronger. You're unlikely to break any of these bars, but Nitto, a conservative maker when it comes to safety, likes it when we say the non-heat-treated models are for roads only.

Different Grips on Drop-Style Handlebars

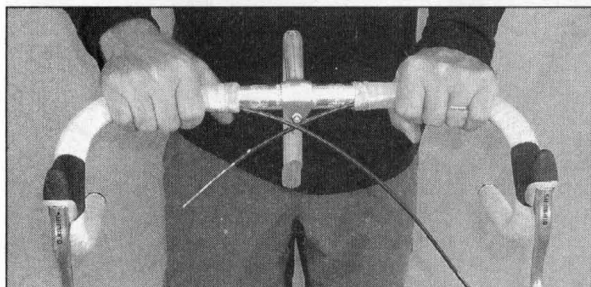

Grab the tops

to allow you to sit more upright. It's the normal position for long, seated climbs and low-effort flat-road riding.

It doesn't matter where you put your hands. They'll roam, and wherever they end up is fine. There's no correct or incorrect way to put your hands here.

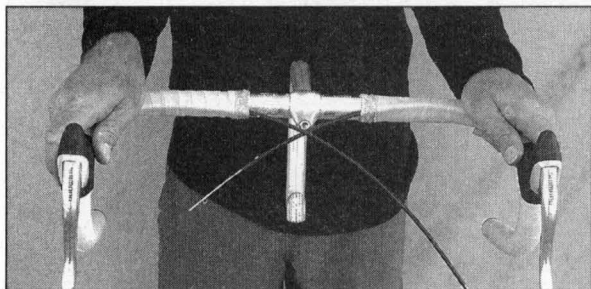

Rest on the ramp

for slightly more aggressive riding, harder efforts, more speed. It leans you forward some, and makes it easy to move your hands to the hoods. This is probably where you'll spend most of your time, which is why the flat-ramped Noodle bar is such a good choice.

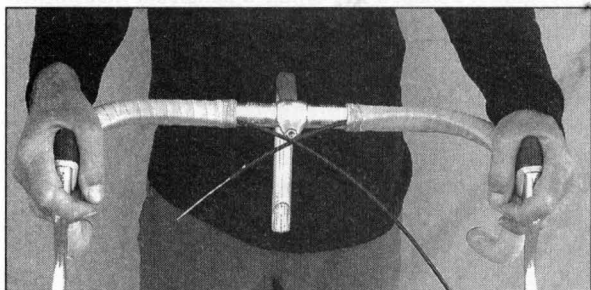

Hold the hoods

for hard riding, like off-the-saddle climbs and seated sprints. The hoods are easy to hold onto while you're pulling hard on the bars to resist your hardest pedaling forces. Gives good access to the brakes. Usually, three fingers go behind the lever, one in front, but do what's comfortable.

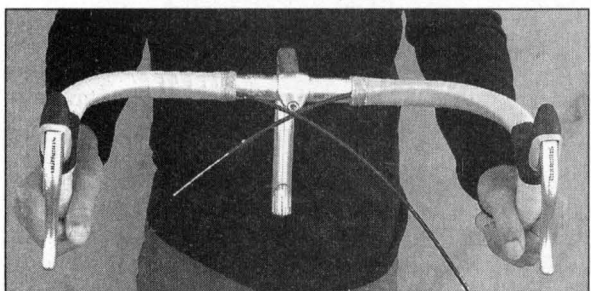

Go down on the drops

For descents and sprints. Grabbing the drops lowers your profile and feels natural for hard efforts. On descents, it gives the best access to brakes. You can brake from the hoods, but you can reach the end of the brake lever from the drops, and that's a more powerful way to brake.

Note To Rookies

Don't get the idea that you'll be judged by whether or not your hand placement is proper according to the pictures above and your effort at the time. Nobody cares or looks, and anyway, this is all stuff that comes naturally. If 100 first-time riders started out on a 10-mile ride over varied terrain, they'd all gravitate to the "proper" hand positions by the ride's end, because what's right is just what feels right and natural.

If you can't comfortably ride the drops when the road is flat, your bars are too low. If you feel too leaned over and committed on the drops during a steep descent, they're too low again. If you can't easily reach the hoods without leaning over too far (for comfort) or straightening your arms, the stem and/or top tube is too long. The bike's got to fit for these positions to work.

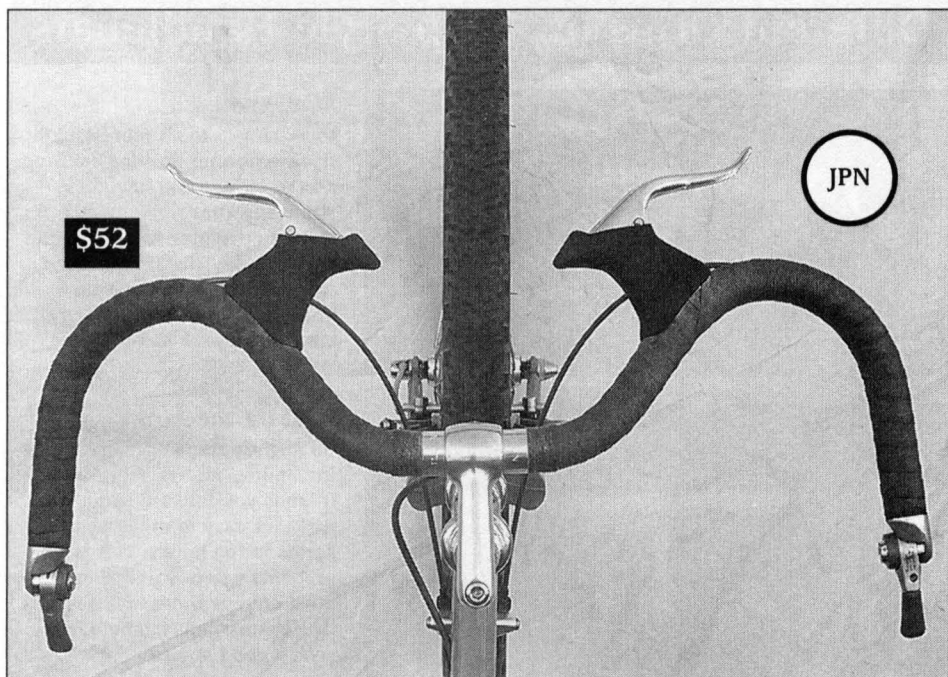

It is called the Moustache Handlebar because it's shaped sort of like a handlebar moustache. That becomes more apparent if you turn this page upside down.

Nitto Moustache Handlebar

Our most popular bar, a variation of a shape that evolved between about 1903 and 1907, and made to our spec by Nitto. It offers the quick and easy braking position of a flat bar with the multiple hand positions of a drop bar—and is better than either for a whole lot of riding.

On a commute bike where speed, visibility, quick brake access, and multiple hand positions matter, there is no better bar. You can go fast on the road and get more aero than you can with a standard drop bar. The wider-than-a-drop-bar grip helps you to pull up steep climbs and stay in control on bumpy sprints. You can ride the Moustache Handlebar off-road and reach the brakes instantly, just as you can with a straight bar.

We often hear from people who have switched to Moustache H'bars and found relief from back and neck pain. If you're riding flat bars and find them too confining, not enough places to move your hands to, give these a try. If you're now on drops, but want a better position for commuting, towns, or trails, this may be just what you're after. And, if you just have several bikes and want to actually have a variety, put these on a bike and see if you don't ride that one more than ever.

The Moustache Handlebar fits all road fittings and bar-end shifters. Does not fit thumb shifters or normal mountain bike stuff. Heat-treated 2014 T6 aluminum, suitable for off-road riding as well.

When converting a bike from flat bars or drop bars to Moustache H'bars, most riders find they do best with a stem that's three to four cm shorter than the one they're replacing. The Nitto DirtDrop is ideal, and the shorter Nitto Technomic Deluxes work well, too.

MOUSTACHE HANDLEBAR, 26MM CLAMP: #16-028 — \$52



Shown here with aero brake levers, but the Moustache Handlebar works equally well with non-aero levers. On drop bars, some riders don't like non-aero levers because they don't like the cables to curve up. But it's not an issue with the Moustache Handlebar, because the brake levers sit flat, so the cables stay low.

Moustache Handlebar Specifications

Material: Heat-treated Aluminum (2014 T6)

Finish: Satin

Width: 51cm

Reach: 95mm

Drop: 48mm

Weight: 320g

Flare: 6 degrees

Clamp Ø: 26mm

Bar ID: 23.8mm

Shifter compatibility: Road style, any.

Recommended use: Road, touring, commuting, fire trails (no stunts). A good all-around bar.

Moustache Handlebar Tips

1. Angle the ends slightly downward. Five to 10 degrees is about right.
2. Get the part of the bars near the stem level with or above the saddle.
3. Set the brake levers level, and barely on the inside of the forward curve, so that the tips of the hoods (where the cables come out on non-aero levers) are 13 to 16cm apart. This gives easy access to the ends of the levers for good braking when you're in the curve, and offers a narrower, go-fast position when you're trying to go fast.
4. There is no better bar for super steep climbs, than a Moustache H'bar.

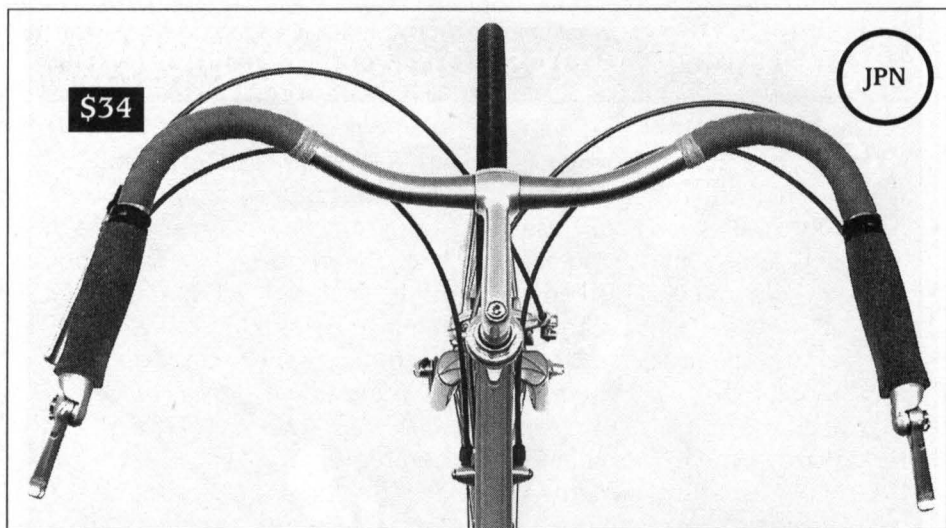

The Albatross's grip is longish, and when you keep the part ahead of the brake lever free, it provides you with another hand position for steep climbs or harder flat efforts. And so, it makes sense to tape it. There's no reason not to continue the tape all the way to the usual stopping place an inch or so from the stem, but it's up to you.

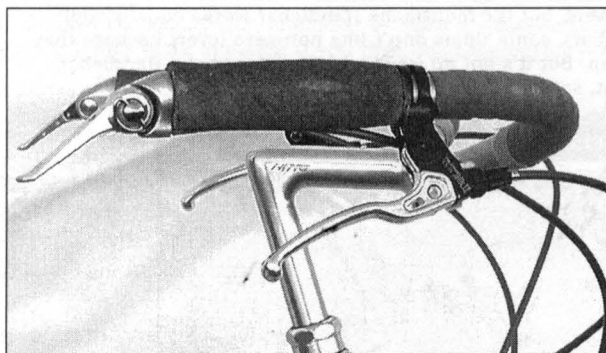

The Albatross has 65mm of rise, which helps sit you upright. But it also works upside down. We prefer the normal (shown) orientation, as it keeps more weight off your hands. Shown with cork grips. Alternative: Put a folded inner tube or cushy foam on top of the bar, then wrap over it with bar tape. Or use half a cork grip. Lots of ways!

The Albatross Bar

This is shaped identically to the Dove Bar, the main difference being that this one comes in two widths (54cm/Aluminum and 56cm/CrMo), and—hold onto your deerstalker—it accepts bar-end shifters, and is stout enough for sane trail riding. You might wonder, as we often do, why the 56cm and 54cm are made with different materials. Part of the reason is that the 56cm is more likely to be ridden by burly-type riders, and they're more likely to need or want wider bars. And the reverse story for the aluminum—although at least one 14-year-old girl rides and likes the wadies. And another part of the reason is miscommunication, which we won't go into here. Either way, it's a great bar, and if you ride a bike and have more than two or three of them, one ought to have this bar. It is the only bar in the world with this luscious look, this super quality, and that'll fit mountain bike brake levers and bar-end shifters. You could just as easily set it up with mountain bike shifters, but it was designed specifically to work with bar-end shifters, and doing it that way frees up more room in front of the brake lever, for a good off-the-saddle climbing grip. I/Grant like riding this bar now, and ride it a lot (average 60 miles per week year round on it); and I just know it's the bar I'll ride full-time when I'm super old, too. If you have a friend who can't get comfortable on a modern bike, the Albatross bar will fix it. Or, if you have a nice road bike you'd like to be ultra comfortable, set it up with this.

ALBATROSS, 56CM CrMo: #16-122 \$32 (GOOD FOR MOST GUYS)

ALBATROSS, 54CM HEAT-TREATED ALUMINUM: #16-127 \$50 (SMALL GUYS, MOST WOMEN)

Try the Albatross on a *Good* Bicycle

Bars this shape get no respect because cool riders associate them with cheap old-fashioned bikes. Too bad! It's a smart, useful, comfortable shape. You can lean forward and climb steep hills off the saddle, or sit bolt upright and see the sights. Although it looks a lot different than a drop bar, it actually feels remarkably similar. The Albatross bar is the best of the uprights we've used (it is made to our specifications, no surprise), and it would be a shame to go a lifetime without having experienced what this bar offers. But the way to do that is on a good bike.

Many of you have an old-and-good road bike around, something you don't ride a lot any more (maybe it's too small, or the bars are too low). Try these bars on it. That bike will come to life like you wouldn't believe. You'll need mountain brake levers. If it has down tube shifters on it, keep them on and try it first before popping for bar-end shifters. A Hobo bag goes nicely on the front. I/Grant ride a bike like this at least 200 miles per month, and I've ridden it in all terrain and conditions. It works great, you'll see. —GP

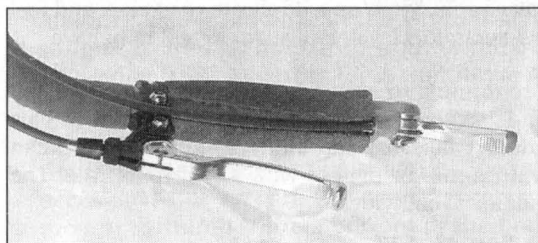

If you go the bar-end shifter route AND want cork grips, become a Cork Grip Surgeon and, with a sharp knife (don't sue us), lop off the end so the shifters can plug the bar, and then cut a slot for the cable housing. In this case, we eventually learned that it's best to reverse the left and right brake levers, and carve a curved slot to guide the housing more smoothly past the clamp.

Indexable housing is stiff; no need to tape it in place. Glue the grips on with 3M Spray Adhesive No. 77 or Gorilla Glue. You can get either at any hardware store.

Albatross Bar Specifications

Material: Heat-treated CrMo (56cm); heat-treated aluminum (54cm)

Finish: Nickel plated, satin (56cm); polished aluminum (54cm)

Width: CrMo 56cm; Aluminum 54cm

Rise/Drop: 65mm (both)

Weight: 470.6g (CrMo); 362g (Aluminum)

Clamp Ø25.4mm (both)

Bar OD: 22.2mm (both)

Bar ID: 20mm

Shifter compatibility: Any style that'll go on a flat/mountain bar PLUS bar-end shifters.

Recommended use: Road, touring, commuting, fire trails (no stunts). A good all-around upright handlebar. You'll like it a lot.

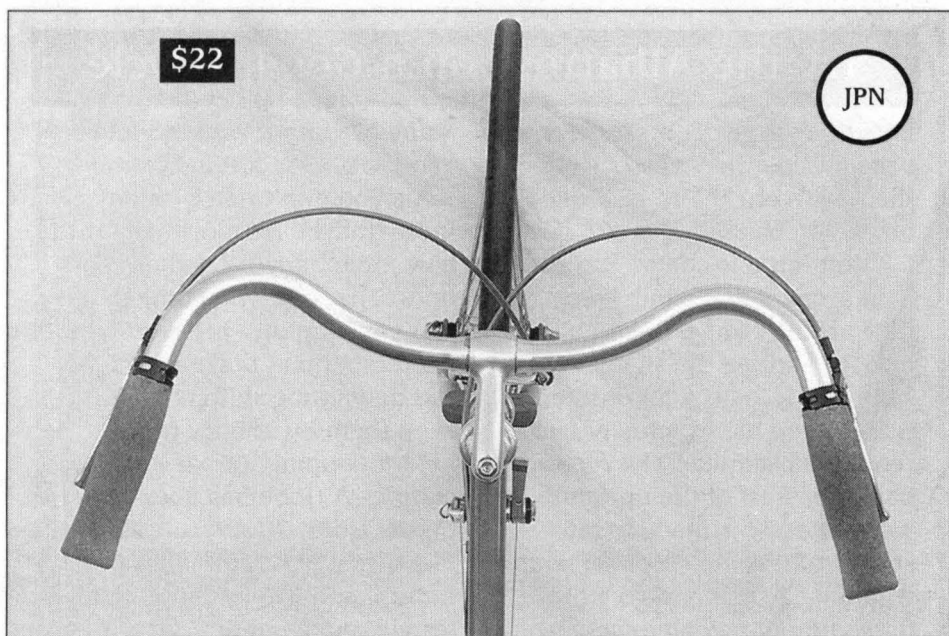

Dove Bar

A genuine, Japanese-built Nitto handlebar designed for super-comfy upright riding. Photos don't do it justice. This bar is humble (no logo nowhere), and has the most beautiful curves, from every angle, that we've ever seen in a bar. It is delightful to ride, and is remarkably ver—despite its old-lady look—satile. Put it on a duplicate road bike, and feel it come alive with a new personality and a comfort level you've got to feel to believe.

It has a 25.4 clamp area, so it's ideal for retrofitting street-bound mountain bikes, too; and the same levers and grips and shifters fit it, so your retrofitting costs are kept down. This bar is not for off-road riding, and it didn't take bar-end shifters—although you can change that yourself if you're handy with a mill or patient with a half-round file. The Dovey is equally fine for children and adults. 51cm wide.

Dove Bar: 16-123

Dove Bar Specifications

Material: Aluminum

Finish: Satin

Width: 525mm

Rise/Drop: 65mm

Weight: 388.4g

Clamp Ø: 25.4mm

Bar OD: 22.2mm

Bar ID: 16.6mm

Shifter compatibility: Any style that'll go on a flat/mountain bar.

Recommended use: Road, touring, commuting. Excellent for children's bikes. Take off those straight bars; there's not a kid in the country who wouldn't rather ride these.

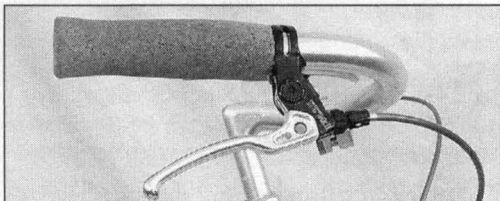
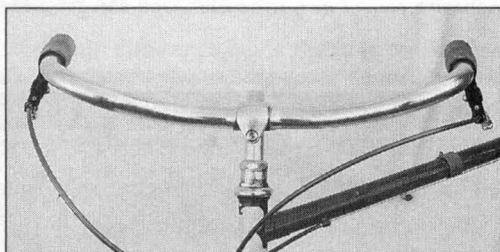

Top: Front view of Dove Bar. The Albatross front view looks the same. Wonderful, gentle bend!
Bottom: Side view of Dovey showing slight rise.

Picking a Handlebar

When you read about each bar individually, they all sound great, so it's easy to get stuck not knowing which bar to get. Keep in mind three things: First, handlebars are relatively inexpensive, and even if you pick a bar that isn't your bar-for-life, you'll still gain something from the experience, and won't go broke doing it. Second, if you have more than one bike, it's sort of fun to have a different style handlebar on each. Not wildly different, perhaps, but noticeably so. Third, every bar in here is good and versatile, and at home and appropriate for all kinds of paved-road riding, and some are fine for off-road, as well. So you can't make a lousy choice. However, the following seat-of-the-pants notes may help you decide:

Get the Noodle if: You want a super comfy all-around road bar. Simple! This is by far our most popular drop bar, and receives more acclaim than any drop we've ever stocked—and we've stocked lots of them and only good ones. We still have the Nitto Dream Bar on-line, and that may be your choice for classical restorations. But the Noodle wins out in all-around comfort, so that's the only one we're showing in here.

Get the Moustache Handlebar if: You want the upright position and immediate access to the brakes that a flat bar provides, but want a bar that offers you multiple hand positions. The Moustache H'bar is a fine all-around shape, but get it at least level with the saddle, and a bit higher is even better.

Get the Albatross if: You want a guilty amount of comfort, but don't want to be limited to an upright position. By grabbing the forward portion of the bar, you can tackle 18-percent hills in much the same body position as you'd have with a drop bar or a Moustache H'bar. Also, if you want that upright position and the option of another hand position for more aggressive or strenuous riding, the Albatross is the only bar in the world that'll provide it. Just use it with bar-end shifters, to free-up the bar in front of the brake lever. The ONLY thing we don't recommend the Albatross for is multi-mile steep descents, or super-bumpy trail descents. For that, it's best to have a bar that braces your hand so you don't have to grip it hard to hold your place (so—the Moustache, or a drop bar).

Get the Dove if: You want a beautiful, inexpensive bar for upright riding and the occasional hill or sprint. It won't accept bar-end shifters, so you'll likely be mounting thumb shifters in front of the brake levers, and they'll make it harder to put your hand there. Actually, you could use twist-o-grip shifters. That's not a bad idea at all, except that they don't have a friction option, and you know how that gnaws at us.

Opinions About Handlebar Shapes

1. Varied terrain and varied efforts require variable hand positions. Curved bars (all the bars we sell are curved) provide that. Straight bars don't.
2. When you lean forward and get off the saddle, it's best to have your wrists facing inward. All the bars we sell do that. The wrist-in grip is the reason you can set up the Dove or Albatross close to you, for a good town-riding position, and still be able to climb hills aggressively and efficiently.
3. For steep, rough descents, it's best to have some bar in front of your hands. If you don't have part of the bar there to block you, you have to grip the bar too tightly. The bar in front of your hands lets you relax without risking slipping.
4. Moustache H'bars are most comfortable when they're as high or higher than the saddle. And while you're at it, use a short stem with them.
5. Wider bars give you more control over a loaded bike. Think of them as a longer lever you use to resist the thrust of your legs and the tilting bike.

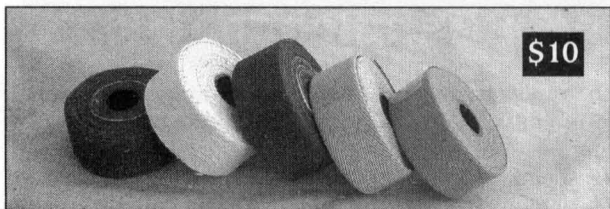

\$10

Silver: 16-124;
Mint: 16-125
Dk Green: 16-143;
Dk Blu: 16-141
Lt. Blu: 16-142;

THE WEAK CASE FOR COTTON BAR TAPE

Cotton lacks the cush and absorbency of cork, and what besides cush and absorbency matters? Looks is what. Cotton scores a B-minus in function, but an A + + + in looks—dark colors fade with age, and all cotton eventually frays nicely at the edges, exposing the bar silver bar beneath. A wrapped handlebar is skinny and looks nicely proportioned to the rest of the bike, too.

It's not cotton against cork.

Ride both, see what you like. And, if you're the Einstein-like genius we heard you were, you'll have at least one set of drop-bars wrapped with cotton. Japanese cotton, in particular. Bought right here, specifically.

Japanese Cloth Tape

The bar tape maker quit making this, but begging and big orders brought it back, just for us. It's the finest cloth tape we've used in 35+ years of using cloth tape. The weave is dense and soft, the colors are rich and lovely. If you're a cork fellow, fine, stick with cork; but if you still like cloth, you will fall in love with this, and wish you'd had it years ago.

The dark green & medium blue are especially lovely; and silver is always good. All the colors are full and deep. Spotty supply until February 11.

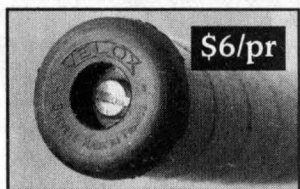

\$6/pr

Velox Plugs

The oldest plug around, and the top choice for daytime riders and classicists. Black. France

Velox Plugs: 16-077

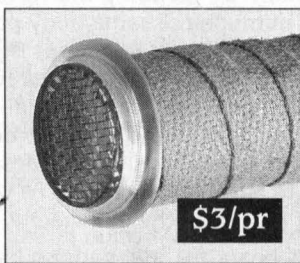

\$3/pr

Reflector Plugs

Half the price, less than half the weight, and one billion times the reflectivity of the metal screwhead in the Velox plug. Made inexpensively and cheaply in China or Taiwan, and you just push them into

your bars and go. The only plug for lightweight fanatics who want all the visibility they can get.

Reflector Bar Plugs: 16-115

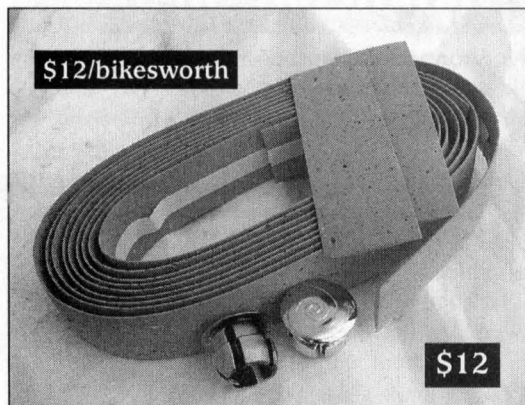

\$12/bikesworth

\$12

Cork Tape

Mark & Robert here ride with cork, and started slipping in some cork on customer builds (without prior approval—horrors!). I tried hard not to like it but failed, and so here it is. We don't specify a brand, we get anything that Mark says is fine. Usually Cinelli. The cork color (natural) gets dirty quick but takes shellac really well, looks like leather, and stays clean that way. The medium blue gets picked a lot for Rambouillets. The dark blue is a bit lighter than navy.

Cork: 16-130

Dark Blue: 16-138

Medium Blue: 16-146



Hemp Twine

Once you've taped your handlebars, do you really want to trim them with electrician's tape? We like cloth for the main bar, and twine for the last 5/8-inch or so. You can then shellac over the twine (do the shellacking all at once, after twining); or use waterproof contact cement to maintain the twine's natural color. One ball does about 90 handlebars.

Hemp Twine: 16-086

Wrap the last three wraps over a separate loop of twine, then pull the end through.

Shellac

Shellac is the cinnamon-colored bug excrement from India, and has been used to protect and improve cotton handlebar tape for more than 58 years. It increases durability and adds rich color and texture, allowing you to make your tape grippy or smooth, depending on how thick you apply it. Here's a tip: Go to a hardware store and get Bullseye/Zinsser brand shellac in a can. It's cheap, easy, and get a cheap brush, too. Get Clear or Amber. The amber, especially, turns any color cloth richer. It turns blues to olives, white to buckskin, yellow to goldenrodish, and so on. \$10 for a 90-bar supply.

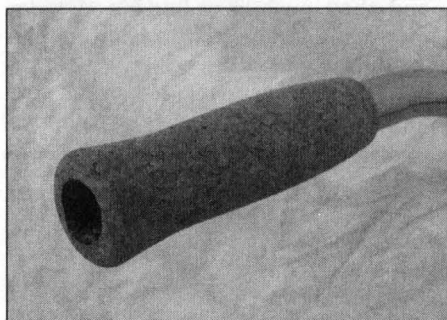
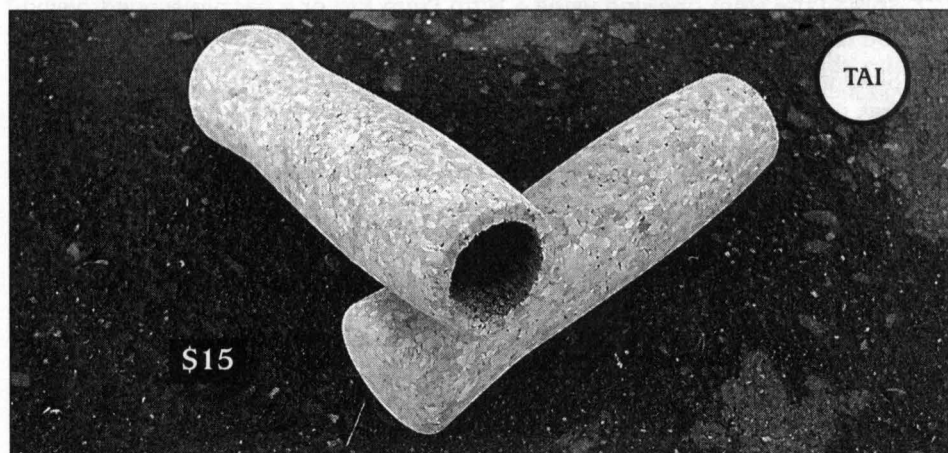

They come with one closed end, but if you're good with tools and clever, you can make a 7/8-inch hole in one end, so bar-end shifters can mount. That's the best way.

Cork Grips

These feel as good as they look. Slightly spongy, just like cork. Never cold in freezing temperatures, nor sticky in hot. They're kind of expensive, at \$15 per pair, but that's only about \$4 more per pair than most grips, and these are cork, which, you don't even have to kill the tree to get it, so there.

You have to glue them on. Use 3M Spray Adhesive No. 77 or Gorilla Glue, both available at an hardware store. Just follow directions and test before riding. Don't do a lousy job and then pull them off, crash, and sue. Please, just glue them on securely.

Cork Grips: 16-103 \$15

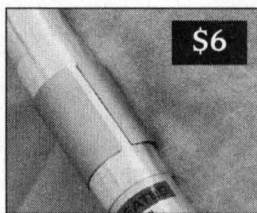

25.4-to-26.0

Handlebar Shim

The best way to shim a 25.4mm handlebar to a 26mm stem is with these shims made just for the purpose. Yes, you can cut up a pop can if your time is worth zilch to you and you enjoy frustration and failure. Otherwise, get these. They make Albatross, Falcon, and Dove bars, or mountain bike handlebars fit the road-standard 26mm road stems. The easiest way to install them is to lube up the bar and shims, and use a stem pry to open the stem. You may need to push the shims back into place with a screwdriver, if they slip away. It's not science, but when shimming's what you have to do, these are the best and easiest to use shims you'll find.

Shim: 16-095

SHIM TIPS. The more of these tips you use, the easier it'll be, but if you're patient and persistent and reasonably okay with fix-it projects, you may be able to do fine without any of them (tips):

1. Apply a greasy, tacky lube (lanolin is perfect, grease is okay) to the stem bore. Then put the shims in the stem, before inserting the handlebar.
2. Spread the stem opening using a Nitto Stem Pry or a big old screwdriver. If you use the screwdriver, it will be helpful to have another set of hands.
3. Slide it on as best you can without scratching, and cinch it up tight. If it seems to slip, take it off and remove grease from the bar.



Smart Headset Locknut

For the most part, when you adjust a normal threaded headset properly, that's it, it'll stay put. But for five bucks, what the heck, this one here is a good deal and a smart purchase if you ride off road a lot or have a longish tour planned. It looks normal enough, except for a couple of tiny allen bolts sticking out, and it's pretty smart. You put it on in place of the normal locknut, and then turn in the allen bolts some, and they push in a hidden ring (as opposed to biting the threads themselves); and once that's done, even King Kong couldn't shake your headset loose. So, cheap insurance for the paranoid.

Blue: 30-016

Silver: None left

Black: 30-018

Taiwanese Forged Clamp-on Cable Stops

If you aim to mount bar-end or thumb-shifters to a bike that formerly had clamp-on downtubers, these are what you need. All silver aluminum, nicely made and fine to look at. We stock two sizes, and when you need them, they're worth twice the cost:

For 1 1/8" (28.6mm) tube: 17-109 \$10

For 1 1/4" (31.8mm) tube: 17-110 \$10



The Secret To Comfort? Raise d'Bars!

If You Don't Read Anything Else All Year, Read This Page

The most influential factor in your riding comfort is your riding position; and the most influential part of your position is your handlebar height. Ninety-nine percent of all road cyclists ride with their handlebars too low. When you raise your bars, good things happen.

WHY HIGH?

1. Relaxed, comfortable position. Higher handlebars sit you more upright and take weight off your hands and arms. Your triceps don't tense up, and your hands don't go numb. With your arms relaxed, you can easily absorb road and trail shocks almost intuitively, by letting your body flex at the joints and act as a spring.

Higher bars also relieve strain from your neck and lower back. And if you can eliminate or reduce pain in your hands, arms, neck, and lower back, you're going to be comfortable, period.

2. Better descending. On a descent, you're already pointing your body downhill, and low bars just increase the steepness. Higher bars make any hill seem less steep, so you'll relax more, and enjoy it more. You'll be less likely to panic, and panic causes crashes. Higher handlebars make descents safer and more fun.

3. Better vision! Higher handlebars sit you more upright and give you a better view of traffic, the road, and the sights.

4. You'll ride more. Riding a bicycle is inherently fun, but body pains put a stop to it really quick. Higher handlebars can prevent most of the pains you suffer, so you'll ride more.

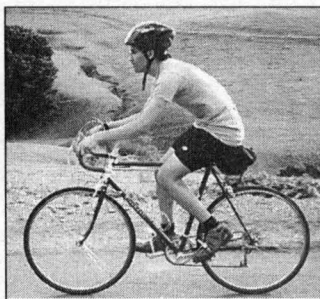

High handlebars give Debashis a relaxed position, good for comfort, vision, and descending. The stem here, a Nitto Technomic Deluxe, is one of many stems that can help you get a similar position. Starting with a bike that fits helps, too.

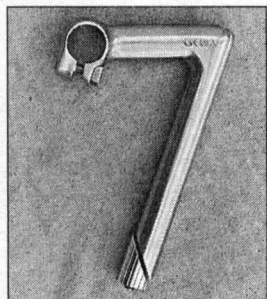

How To Raise Your Bars

First, measure your saddle to the ground, then your handlebar tops to the ground, and see what the difference is.

If you're typical, your handlebars will be about five cm lower than the saddle. That's too much! Most riders are happy with the handlebars level with the top of the saddle, so start with that as a goal. Any raising of the bars will feel better, and there's no magic to making them level. You may prefer them a centimeter or two below the saddle, or six centimeters above it. Either way, brace yourself for a new stem.

If your bike has a **threadless headset** and a horizontal stem, replace it with one that juts up. Up-jutting stems that clamp onto a threadless steer tube are not common, but if your local shop doesn't have it, maybe they'll special order it for you.

If your bike has a threaded headset, get:

1. A stem with a longer quill. If your stem's quill is 135mm and you want to raise the bars 35mm, you'll need a stem with a 170mm or longer quill.
2. A quill-style stem that rises, such as the Nitto DirtDrop.

Don't raise the stem above the minimum insert line. Also, make sure the new stem clamp diameter matches whatever handlebars you're going to use.

Nailing the perfect handlebar position takes experimentation. We're often asked what stem length should I get? First, just get the bars up there. Guess on the extension, and fine tune it if you need to. A spare stem or two is a small price to pay for a comfortable position.

Finally, don't go walking around the street convinced that only one position will work for you.—GP

Stem Stuff

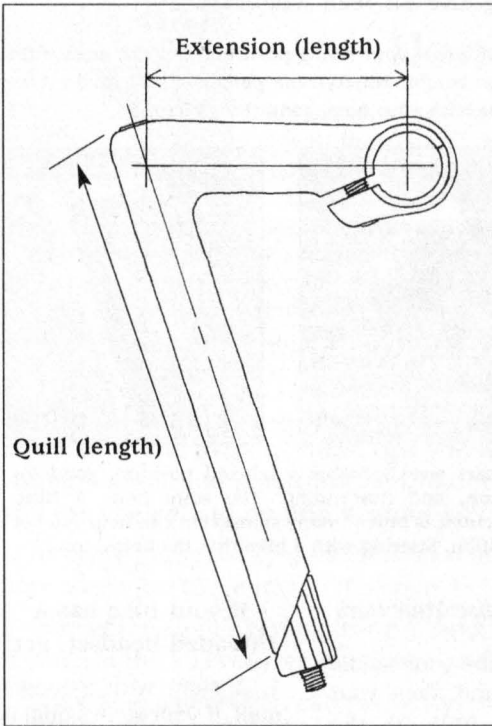

How Our Stems Are Measured

There are different ways to measure stems. The stems in this catalogue are measured from the centerline intersections of the quill and extension to the center of the handlebar clamp, as shown here. Many other stems are measured this way, but we can't vouch for all of them. The other ways to measure stems result in either a shorter or longer measurement, but only by about 7mm.

Don't wrestle with stem length too much, and don't make the mistake of thinking you can ride only one length. As you may already know or can see by the diagram below, the actual, measured length of the stem's extension is one of many things that affect how far you have to reach or lean over to grab the bars.

What Happens When You Raise Your Stem?

Lots of things, all good.

1. As shown in the diagram, the bars come back toward you. By how much? To figure that out, measure L , the amount you want to raise your stem. Parallel to (in line with) the quill. Multiply L by 0.3, and you get D , the Distance they move back. This formula works with a stem with a 72 to 74 degree angle, but if your life is one of precision and arithmetic, then:

$D = L \cos \vartheta$, where ϑ = head tube angle. But multiplying by 0.3 is good enough for normal folks.

2. As you raise the bars, your arms become more horizontal, and therefore effectively longer. Again, trigonometry can prove that, but if you stand 10 inches from a wall with your elbows at your side and rotate your lower arm forward, you'll see that the more horizontal it becomes, the further out there it reaches.

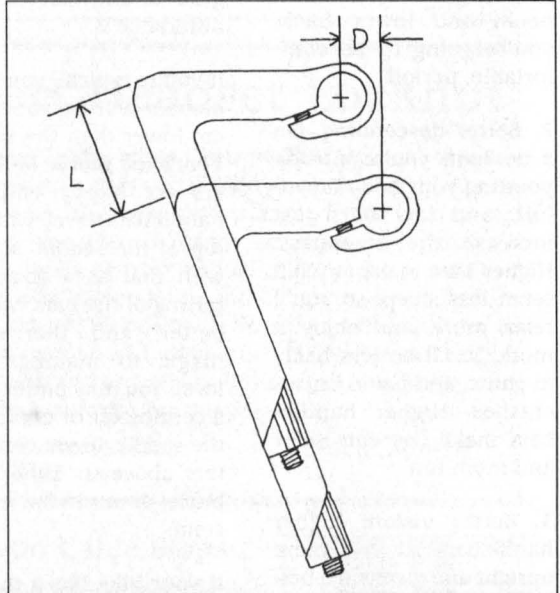

Every stem has a maximum height mark, located about 60mm up from the bottom of the quill. This should always be buried; and if your frame has headset spacers and your stem tightens with a wedge (as does the one here), it's a good idea to sink the mark 15mm lower. Finally, over tightening the wedge can damage the steerer. Sources disagree on how tight is right, but we recommend snugging it to the point where you can't make it rotate in the steer tube, and no more.



From left to right:: Technomic Deluxe. Lugged, Normal Technomic, Periscopa, DirtDrop 8cm, DirtDrop 10cm. You'll see the bottoms of the stems aren't exactly all at the same height, but the point here is that the DirtDrops and Periscopa really jack the bars up. But even the Technomic Deluxe, shown here as the lowest, gets the bars much higher (almost two whole inches) than a normal stem—a Cinelli, for instance, or a normal clamp-on stem.

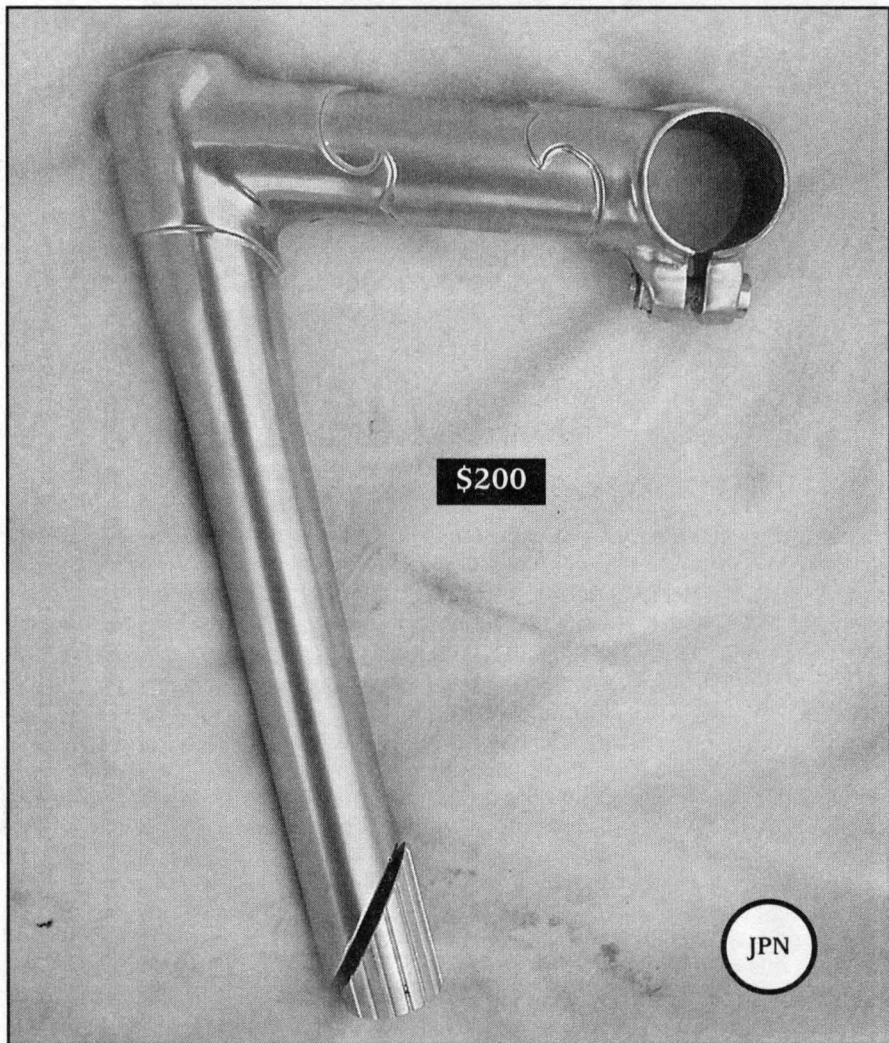

Rivendell Lugged Quill Stem

When there's nowhere else on your bike to upgrade, your house is paid off, your children are through school, your accountant tells you to spend more, your wife just spent \$500 on opera tickets, and your children say, "Forget our inheritance—enjoy life!", then treat yourself to this stem. It is brazed by Nitto, and more specifically, by Nitto's Noriko Yabashi. In strength, beauty, and longevity, it can't get any better than this.

At \$200, it's almost, but not quite, embarrassingly expensive. When you consider that mass-produced Taiwanese stems with American and Italian logos on them sell for about the same price, and Taiwanese ergonomic handlebars sell for up to \$130, then \$200 for this truly hand-made, super strong, and uniquely gorgeous stem seems nearly reasonable. If you're still on the fence, consider that steel stems don't fatigue the way aluminum ones do; and don't fail catastrophically the way carbon fiber stems do (when they do); so this stem is a lifetime investment. You won't have to look at it in 20 years and wonder: Am I going to die on my next ride? Besides, the stem is a highly visible part of your bike, and a beautiful stem such as this is more fun to look at when you're riding.

8cm: 16-088

9cm: 16-089

11cm: 16-091

10cm: 16-090

12cm: 16-092

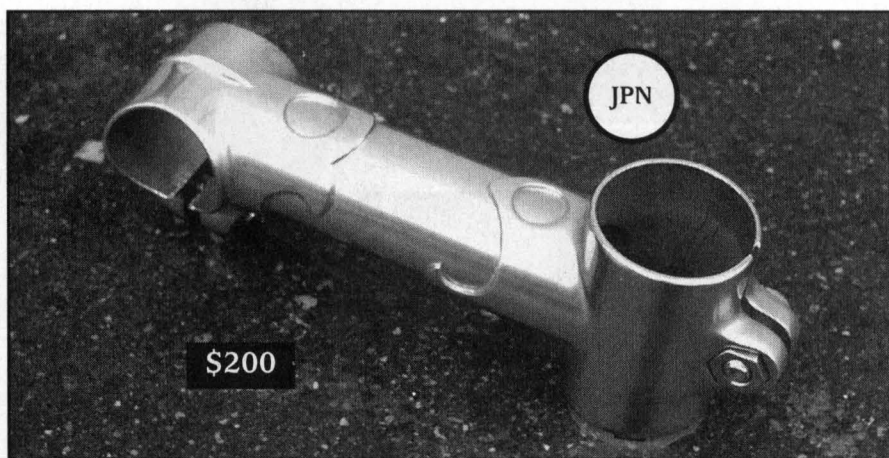

Rivendell Lugged Clamp-On Stem

When there's nowhere else on your bike to upgrade, your house is paid off, your children are through school, your accountant tells you to spend more, your wife just spent \$500 on opera tickets, and your children say, "Forget our inheritance—enjoy life!", then treat yourself to this stem. It is brazed by Nitto, and more specifically, by Nitto's Noriko Yabashi. In strength, beauty, and longevity, it can't get any better than this.

At \$200, it's almost, but not quite, embarrassingly expensive. When you consider that mass-produced Taiwanese stems with American and Italian logos on them sell for about the same price, and Taiwanese ergonomic handlebars sell for up to \$130, then \$200 for this truly hand-made, super strong, and uniquely gorgeous stem seems nearly reasonable. If you're still on the fence, consider that steel stems don't fatigue the way aluminum ones do; and don't fail catastrophically the way carbon fiber stems do (when they do); so this stem is a lifetime investment. You won't have to look at it in 20 years and wonder: Am I going to die on my next ride? Besides, the stem is a highly visible part of your bike, and a beautiful stem such as this is more fun to look at when you're riding. In stock March 2005, but order now to make sure you get one. No payment until we ship.

8cm: 16-148

9cm: 16-149

11cm: 16-151

10cm: 16-150

12cm: 16-152

Quill Stem or Clamp-On?

Whichever your fork requires. If the question is, "All things equal, is one better than the other?", our answer would have to be Yes, the quill stem, the old-fashioned, outdated, obsolete, archaic quill stem is still better if you value being able to raise your stem & bars easily and a lot. But if raisability doesn't matter to you and a clamp-on stem can put the bars where you want them, then it doesn't matter which you go with, because they both work well.

That's the thing here: They both work well. There are minor differences in setup and adjustability, and one mechanic may prefer one way and another another way, but there's no clear winner.

All of our bikes, so far, have been designed around quill stems and threaded headsets. It's conceivable that at some point we'll offer an option, or maybe a whole model that uses the other kind.

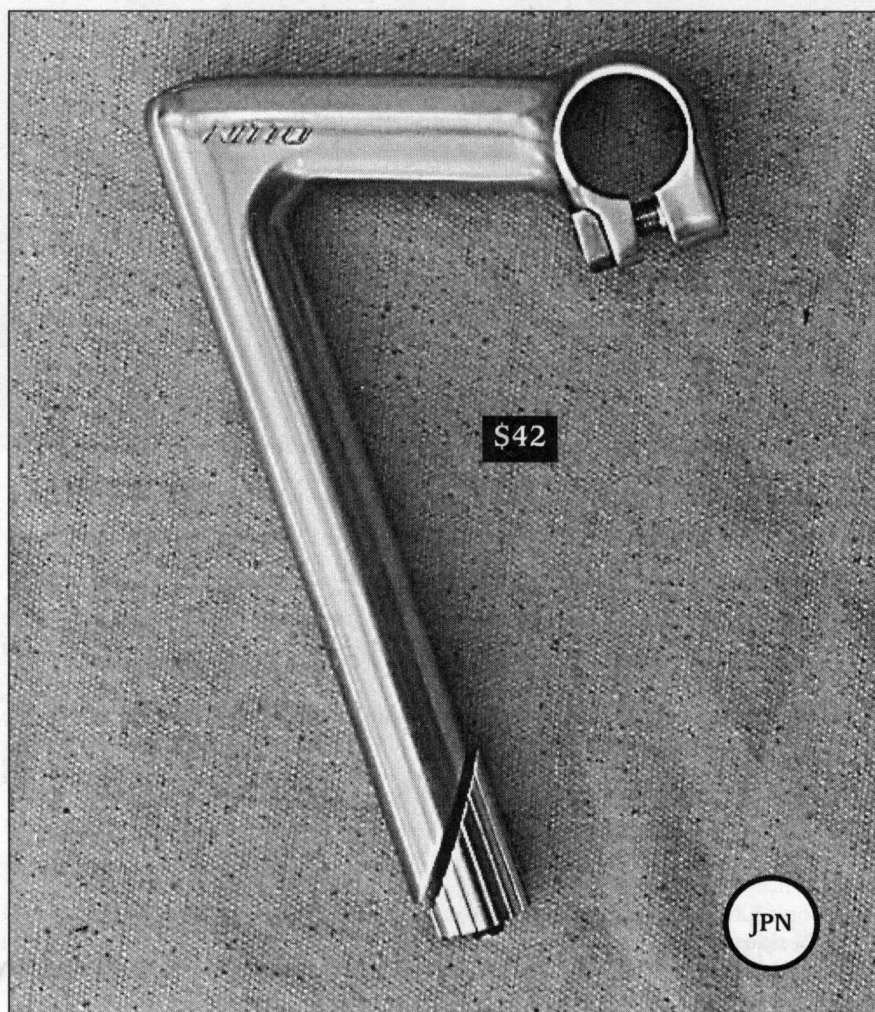

Nitto Technomic Deluxe

Year after year, this is our most popular piece of metal. We have customers who put them on all of their bikes, and it is the stem we most often put onto custom-assembled Rivendell Atlantis and Rambouillet bicycles.

It has so much going for it. The quill is 190mm long, so you can raise your bars about an inch and three-quarters higher than is possible with a standard 135mm-quill stem (like a Cinelli or 3ttt). It makes a dramatic difference in your body position and weight distribution. The higher handlebars shift weight to your rear and off your hands, and as that happens, your whole upper body relaxes, and you reduce the strain on your lower back and neck, too. It's a good way to ride!

All those benefits would justify this stem even if it were ugly, but it is beautiful, with proper proportions and finish worthy of any bike. It's a Nitto, so you know it's strong. The 26mm clamp fits almost all road handlebars (not 26.4mm Cinelli bars, though). The quill fits every normal, 1-inch threaded steer tube except old Frenchies.

7cm: 16-044

9cm: 16-046

11cm: 16-041

8cm: 16-045

10cm: 16-040

12cm: 16-042

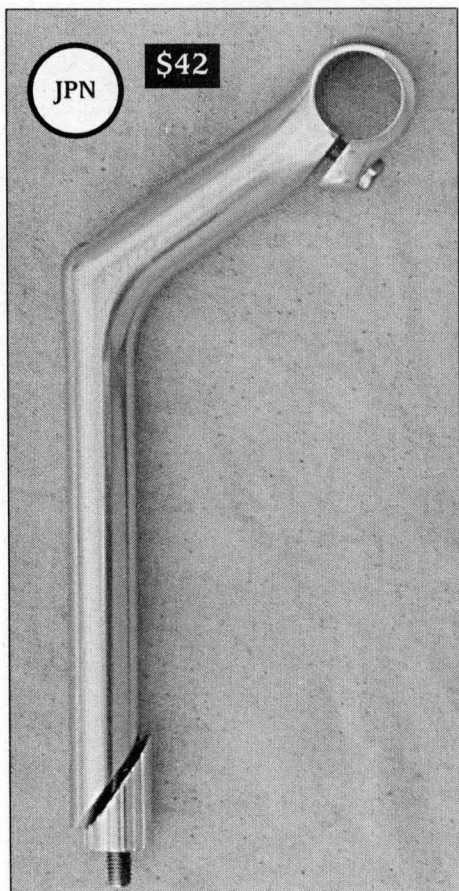

Nitto DirtDrop

Sometimes not even the Technomic Deluxe can jack your bars up high enough. Maybe your bike is too small, or your back is too bum, or you're converting an old road bike to a commuter or a family-riding bike; or a flat-bar mountain bike to one with Moustache Handlebars or drops. Maybe you're a 68-inch tall woman who has been trying to get comfortable on a new and expensive 52cm road bike. This DirtDrop stem is the best stem for any of those uses because it brings the bars back and shoots them to the moon. More helpfully, it raises them higher than even the Technomic Deluxe does.

Like all our stems, it is made in Tokyo by Nitto. The quill is 22.2mm, and fits normal, 1-inch threaded steerers. The clamp is 26mm, to fit most roadish bars made today. In 8cm or 10cm.

10cm: 16-100 8cm: 16-007

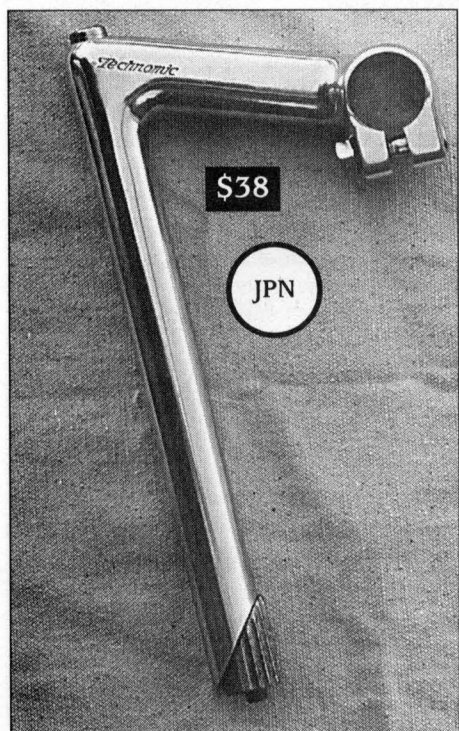

Nitto Technomic

This is the classic backsaver that's been around for decades. It's a gravity cast stem, not forged like the other Nittos, but it's still plenty strong for road riding; although if you're up around 250 lbs and tend to be hard on gear, we suggest you don't raise it all the way up. Or just get the 10cm DirtDrop stem instead. The finish isn't as smooth as it is on the other stems, but it still scores a solid B+. It's made by Nitto, after all, and Nitto is incapable of ugliness.

The quill is a periscopic 225mm. We offer this in 9cm only, but now in both 25.4 (for Albatross & Dove bars, for instance) and 26.0 (for the other bars in this catalogue, and most drop bars). If your bike is way too small, this'll help.

Nitto Technomic 9cm

25.4cm: 16-047 26.0cm: 16-120

Nitto Periscopa

The Periscopa is basically a low-cost Nitto stem intended to jack the bars up high for the lowest possible price. It still costs 4x what a Taiwanese stem costs, but it is Nitto, after all, and being Nitto, you can trust it with your life. It is a bargain at this price.

It lacks the fine polish of a Technomic Deluxe, but there's nothing crude about it, and I say that as an ascot-wearer. It comes in one extension only, 80mm, with a 190mm quill. If you have an old bike of any kind that nobody rides because it's just not comfortable, you can put on this Periscopa and Dove or Albatross bars, and presto—the bike is now fun to ride.

The clamp is 25.4mm, so it fits all mountain bike bars, and the Albatross and Dove. The quill is 22.2mm, so it fits all normal bikes with 1-inch threaded headsets. If you are a guy, you will be amazed at how hard it is to hold this stem in your hand without pretending it's a six-shooter. Hold it in your hands when you're sitting on the couch, and you'll be aiming it at the TV in no time.

8cm: 16-131

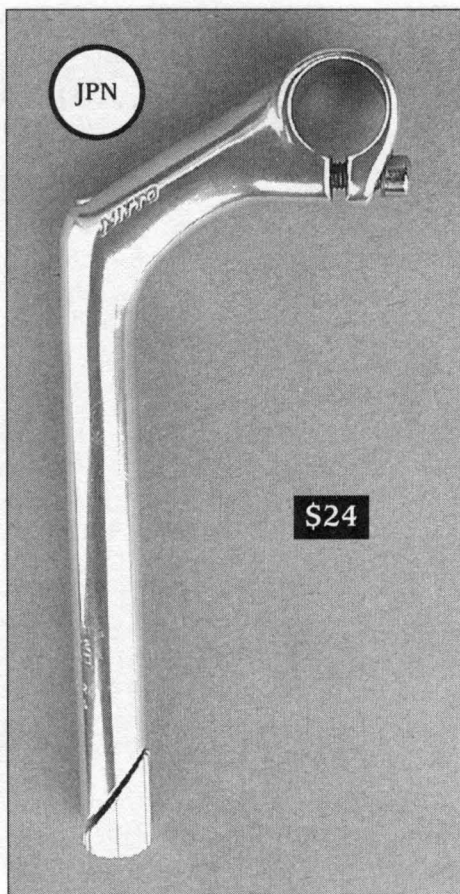

Nitto For Rookies

Nitto is a small (48-person) old (since 1923) handlebar-stem-seat post-rack-and-bottle cage maker in Tokyo, and everything Nitto makes is the best of whatever it is. The designs are always spare and beautiful. Nitto's company slogan is "Light weight, heavy duty, finely made," and it is apt. There are lighter seat posts; but Nitto's are light enough, and stronger. Nitto will not build anything to its customer's specs if it doesn't pass Nitto's own internal standards. Nitto was at its biggest in the early to mid-eighties, during the mountain bike boom. Back then, the dollar-to-yen exchange rate was 250:1, and it was cheap to bring in Japanese goods. These days it's 109:1, which is why almost nothing you buy is made in Japan.

Nitto can bend metal in ways that other makers just plain can't. Mr. Yoshikawa, who designs most of Nitto's products, has an eye for beauty that, in my experience, is unmatched. He takes our ideas and rough sketches, and turns them into stunningly lovely shapes—the Moustache Handlebar, the Noodle Bar, and he tests the heck out of them to make sure they're safe.

There aren't many companies like Nitto these days, and none other that I'm aware of making bike parts. It is a pleasure and an honor to offer them to you. Every loved bicycle deserves some kind of Nitto on it!—Grant

Easy Living with Leather Saddles

There are reasons experienced riders happily pay \$90 to \$150 for a relatively heavy saddle. Some do it just because leather saddles are far and away the best looking saddles out there, but most do it for comfort. Being leather doesn't guarantee comfort in a saddle any more than a lugged and steel bicycle guarantees a comfortable position. There are lots of uncomfortable leather saddles. But it so happens that the best-designed, most universally appealing and comfortable saddle out there—the Brooks B.17—is leather.

Although leather saddle makers have always bragged about leather's breathability and how that keeps your crotch cooler—and how that in turn reduces all kinds of problems—we feel the main contribution that any saddle can make is its *shape*. The shape could just as easily be achieved with plastic and foam, but it usually isn't. The Avocet Women's Air 02 touring saddle has a good shape, and if you don't want to deal with a leather saddle, it's worth a try even if you aren't a girl. However, if you like the idea of a leather saddle and want to get the most out of it, here are some tips.

1. **Use goop sparingly.** On the top at least, and on the underside if you feel like it. Whether it's Proofide or Obenauf's, don't overdo it. You'll stretch the leather, and once it's stretched too much, it'll sag and lose its shape and ability to work. Leather saddles have tension bolts in the underside of the nose, and they can tighten things up a bit, but tensioning alone can't reshape a big floppy saddle.
2. **Never ride it wet.** One wet ride may not kill it, but on the other hand, it may. Wet leather stretches easily, and if you're a big guy pounding down the road on a saturated saddle, that saddle will likely suffer damage that you won't be able to fix. Leather saddles are for year-round riding, but only if you protect them from getting soaked. Plastic bags or saddle bonnets are the way to go in the wet. Got a leather saddle? Then get a cover for it, period.
3. **If it gets wet, let it dry slowly,** at room temperature.
4. **Don't store your bike outside for weeks at a time;** or cover it if you do. You wouldn't sunbathe yourself for that long, and your saddle is just skin, and there's no cow to take care of it anymore.
5. **If the side flaps start to flare out, drill five to six holes** in the lower part of each flap, then lace the sides together with a shoe lace or zip ties.

That's all there is to it. Don't be scared. All natural products require more care than does plastic, but it's not a hassle. Four catalogues ago I suggested that you could expect a good leather saddle to last 15,000 miles. I was deluged with claims of two and three times that. I still think that's optimistic, but whatever it is, leather saddles are a bargain, and we're all lucky that they're still being made. Brooks, by the way, was recently purchased by Selle Royal, one of Italy's biggest saddle makers. No bad changes are planned!

Three Things to Seek in Saddles

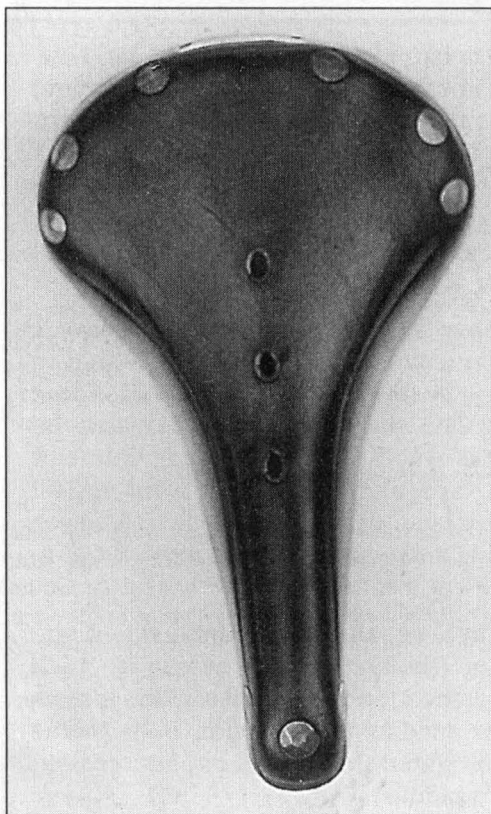

ONE: ENOUGH WIDTH

The rear part of the saddle should be wide enough to support your sit bones. This is a Brooks B.17, and it happens to be 17cm wide, which, based on where the sit bones imprint the leather, seems to be about minimum width for a good saddle. Yet the typical racing saddle is about 15cm wide.

Racers are light, leaned over, and pedal hard all the time, and that combination reduces pressure on the soft spots. That's not to say they don't get numb or sore; but for a heavier rider with a more practical, comfortable riding position, a narrow racing saddle is not a good choice.

TWO: A FLATTISH REAR

That's so your sit bones don't try to slide off it. If they do that, there's upward pressure on your genitals, and forget it. If you look closely at this saddle, you'll see indentations made by sit bones.

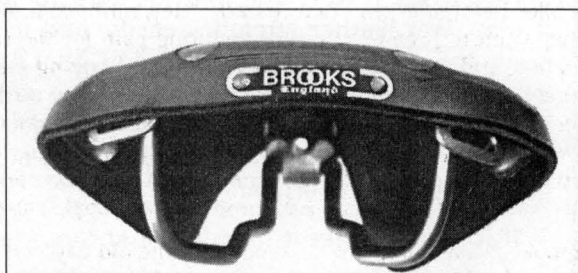

THREE: A HIGHER REAR THAN MIDDLE

See how the rear part of the saddle, where your sit bones rest, is a bit higher than the middle, where your genitals are? It makes a big difference. It reduces pressure on your genitals. Make sure the rear is higher than the middle.

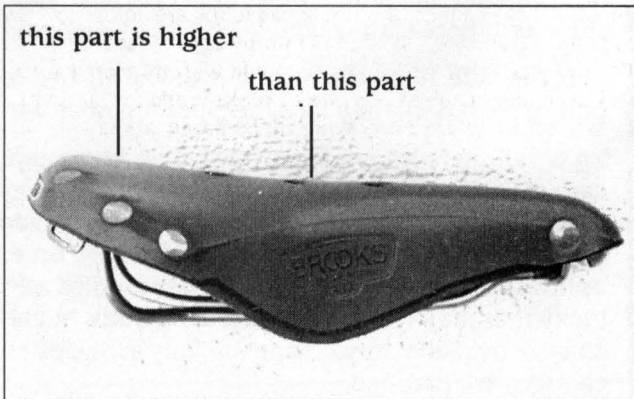

see www.rivbike.com for Brooks availability (delivery has not been good, but we'll do all we can to keep them in stock)



Brooks B.17

This is one of Brooks's oldest models, and is one of those rare products of any kind that is unimprovable. The B.17 is a fantastic, and truly 97 out of 100 riders will find it just right. The magic of the B.17 is its shape. It's wide enough (at 17cm wide; that's likely where the B.17 comes from) and flat enough in back to support your sit bones. It's shaped right, so if you set it up properly with the rear portion slightly higher than the neck, it won't cut off flow to your plumbing or crush your folds. Every now and then we find somebody who can't ride it. It's too wide. Mark here is like that. But it's rare, and if you're not loving the saddle you're on right now, and especially if you've been through a bunch of saddles and never warmed up to any of them, this is the logical next step.

There is a rumor, perpetuated by those who have never ridden a B.17, that leather saddles are uncomfortable and take forever to break in. When the new crop of cyclists sees one on a bike, he or she will often remark, "Hey, retro, cool, but isn't it uncomfortable?" It's like they want to high-five you for enduring pain for the sake of tradition. It isn't retro, it is leather, and leather has proven itself a good seating material for hundreds of years, in all kinds of applications. *It's incredibly comfortable.* It would be foolish to pay more for a heavier saddle that was uncomfortable. A B.17 is hard when it is new, but the shape is right, and we hear from folks who get one on Friday and begin long tours with it on the weekend, and have no problems at all. They love it. One woman wrote that it began to bother her 350 miles into an ultramarathon ride. Most people can't sit in a chair for that long.

Brooks saddles are hard to come by. In the old days, we could get the B.17 in assorted colors and rail materials, and life was good. Two years ago, Selle Royale of Italy bought Brooks, and to its credit, made some nice functional and cosmetic changes in the saddles, including the B.17. For instance, the saddlebag loops are smoother, not as likely to cut into a saddlebag strap. The badge in back is bumpy again (has relief), like it did in the '70s and earlier. The old black standard B.17 was made with thinner leather, but the new ones seem right and thick, like the deluxe models Brooks made for us. So even though the delivery has not been good, there are some things to be happy about.

As for the delivery, we hear it won't be good until Spring of 2005. At that time we hope to be able to offer maybe 3 variants of the B.17, but for now, we've got just the standard Blackie. It's a good one, it's inexpensive, and we're happy to have it!

B.17 Classique Blaue: 11-055...\$70

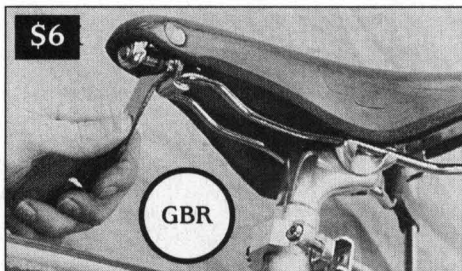

Brooks Spanner: 19-013

Brooks Spanner

You may ride your Brooks for years and never need to use this, but if you ever want to tension the leather, this tool will make the difference between a satisfying experience and wanting to blow your brains out. No normal tool works worth beans, and if you're a Brooks-riding tool person, go for it. Cute, compact, chromed.

Obenauf's

This is the stuff we prefer over all others for saddles, shoes, belts, baseball mitts, and the leather on saddlebags. Made with beeswax and propolis, for firefighters. A blob the size of a pencil eraser will coat the side of one whole Brooks B.17.

Obenauf's dinky tub: 31-243

Obenauf's quarter-pounder: 31-344

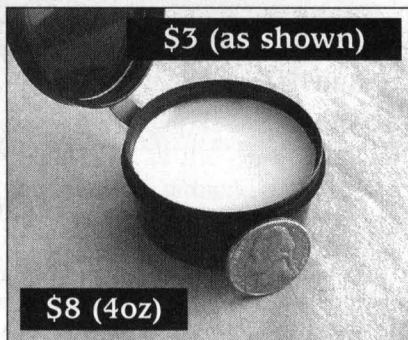

Saddle Bonnet

Riding uncovered leather saddles in the rain ranks high on the list of Bad Ideas That Won't Kill You. Don't do it, anyway. This bonnet here is made for the B.17, and we highly recommend it on rainy days, or hot days when your rear-end sweat is likely to saturate the leather. (If that were good for it, we'd sell it.) When you're out of plastic bags and duct tape, reach for this Brooks B.17 protector, made just for us by Carradice. It's a durable rain cover you can trust to keep your saddle dry in the heaviest rains. Still, it is stitched, so if you're really paranoid, you should put a plastic bag or Glad Wrap underneath it. A natural leather saddle is a delight to ride and an aesthetic grand slam. Keep it healthy! Don't ride it soaked! Black or Grey, no choice.



More leather saddles incubating right now

As of this catalogue going to press, Brooks makes the only leather saddles currently widely available in the U.S. Within a year or two, there will be at least three new ones—we hear. That's a good thing for everybody. We'll continue to sell Brooks, but when the others are available, we'll certainly give them a try, too. It is good for the market and good for bicycle riders to have more than one leather saddle available. I hope nobody at Brooks gets mad about this. —GP



\$55

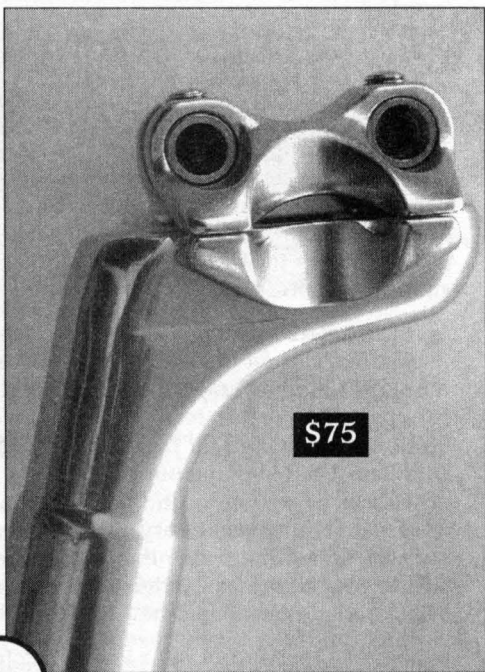

\$75

JPN

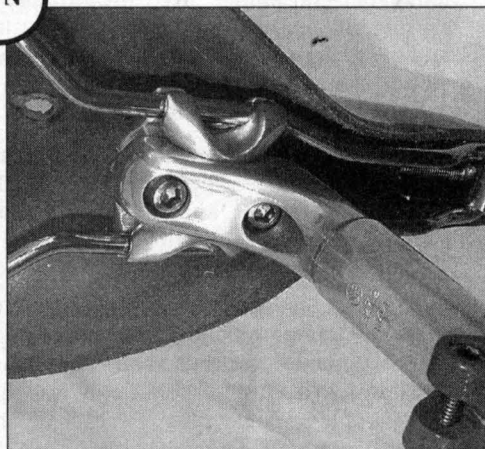
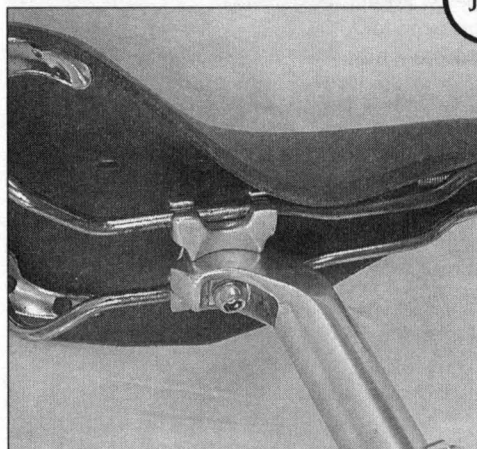

Crystal Fellow

This seat post has a curious name, and is the standard and most popular Nitto post. It's a one-bolt design, so set-up is fast and easy; and so long as you grease the bolt and use a long 6mm allen and put some muscle to it, it'll grip fast forever.

Like all Nitto products, it is both jewel-like and Samson-like, and you cannot get any better. 210mm, 270g, 27.2mm only.

Crystal Fellow: 11-031

Frog

Nitto's elusive two-bolt post, which Nitto calls the Jaguar but we sell it as the Frog, since it looks more frog-like to us. Two-bolt posts are rare, but are also inherently more secure than are one-bolt posts. In the same way that it's easier to hold a long beam overhead with two arms than with one.

It's "elusive" because we don't get many in. In fact, we're probably out of stock, so get the other! 210mm, 270g, 27.2mm only.

Frog: 11-016

A Short History of the Power Ratchet, and Thoughts on Friction Shifting in General

The best shifting mechanism ever invented is SunTour's Power Ratchet. SunTour introduced it in the late '70s in a cheap thumb shifter called the Mighty. It sold for about \$7 per shifter (per side), and was largely ignored until it became the shifter on the early top-notch mountain bikes—the Ritcheys, Breezers, Trailmasters, and so on. Even then, it was seen as too crummy for the bikes it was going on, but it was the only thumb shifter available, and it *did* work well.

As the name suggests, there's a ratchet inside. The ratchet lets you set the wind-up tension light without the shifter slipping under the tension of the derailleur springs. Without this feature, you'd have to set the tension high enough for friction alone to prevent the derailleur from slipping out of gear, and the amount of friction necessary to do that would make shifting itself harder than necessary. That's the way it is on pure friction shifters, like the old Campagnolo ones all the pros and most enthusiasts rode on pro-level bikes around that same time.

In about 1977, SunTour put a Power Ratchet in its first handlebar-end shifter, used on virtually every good touring bike in that touring bike heyday. It became far and away the most popular and widely used bar-end shifter ever made. The same mechanism also made its way into many great-shifting, inexpensive SunTour shifters in the early '80s.

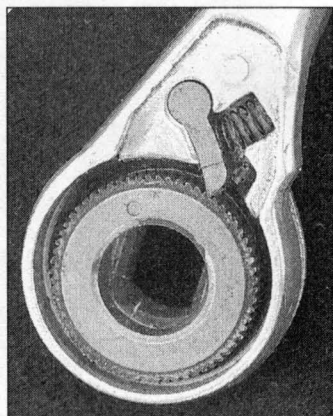

That original version of the Power Ratchet worked fine, but in the 1986 model year (meaning it was developed in 1985), SunTour introduced a new version, with a lighter action, finer ratchet, and used it in its Sprint and Superbe Pro models. This next version improved on something that seemed perfect already. But timing is everything, and just a year later indexing swept over the cycling world.

So there sat SunTour with this perfect shifter, while the market was going ga-ga over indexing. Compared to the narrow, confined working environment of an indexed shifter (gotta use a special chain, derailleur, freewheel, cable housing, and so on), SunTour had a shifter that not only was the lightest, smoothest-action shifter ever made, but it worked with any derailleur, chain, and cogs. It still does. It's unlikely that in our lifetime anybody will ever make a drive train that can't be shifted wonderfully with this mechanism. But bad timing is bad timing, and that's what sunk it.

We bought a huge stock of shifters with this mechanism cheap many years ago, sold them like popcorn, and finally ran out a year and a half ago. SunTour didn't want to make them again, but Dia-Tech did, and with SunTour's generous cooperation and technical assistance, Dia-Tech made us the Silver shifter, with the exact mechanism we've been raving about here. Our timing is no better than SunTour's was in 1986, but our needs are smaller. We aren't after the mainstream rider who talks tech and dreams of racing, and we don't have to sell thousands of them.

Like any non-indexed shifter (or radio that uses dials, for that matter), it isn't as rookie-friendly as finely tuned indexing. There's a short learning curve with friction (non-indexed) shifting, but my oldest daughter had it mastered in a few days when she was 11, with virtually no outside feedback or coaching whatsoever.

You'll master it almost immediately, and once you do, you'll shift faster and more quietly. You'll be free of the frustrations of having to match up the drive train parts. You can put it on any bike and shift away. It frees you and gives you more control, and many folks find it far more satisfying. Don't fear friction shifting—it's simple and fun!

• No. 15 Winter '04 - '05 •

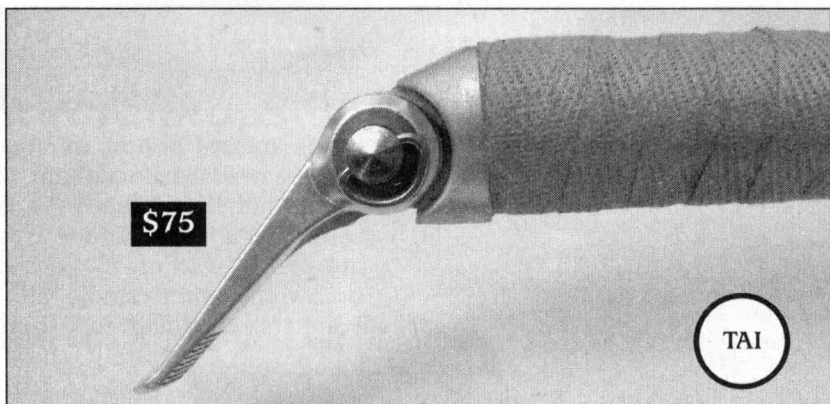

Silver Bar-End Shifters

These are the best bar-end shifters we've used. There's nothing like them, and if you think your old SunTour barcons are the bee's knees, bless you, but you're living in dreamland. Their magic is the Power Ratchet inside, which we tell you all about on page 54. The shifting is smooth, light, simple, fast, and precise. Indexing, in comparison, seems raucous and archaic. They work with any derailleur, and freewheel, cassette, chain, etc., so you have the peace of mind that comes from knowing you'll never be midway between gears and powerless to do anything about it. There's a short learning curve, but don't let that scare you. Everybody learns fast with these. When you buy these shifters, you also get cables, housing, end-caps, shifter boss adapters—all you need to get set up with bar-end shifters. Shifting can't get any better. Easier, yes. But not better.

Silver Bar-End Shifters: 17-089

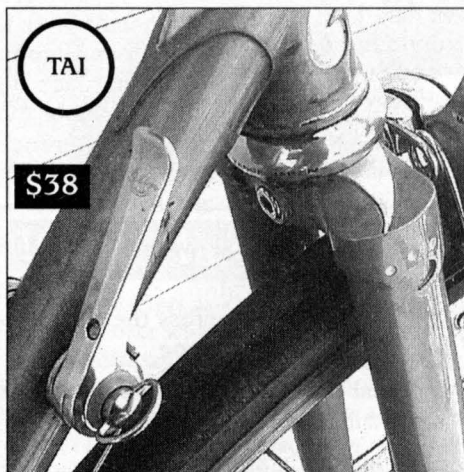

Silver DT Shifters

Most riders who use downtube shifters wouldn't think of using anything else. They're light, out of the way, accessible enough, and they clean up the handlebar area, making bar-stem-tape-brake lever switches quick and easy. Plus, they don't tempt you to shift every time the slope increases ever so slightly. These are the best downtube shifters ever made. At only \$38 per pair, they're the biggest bargain in the county. If you try and can't handle downtube shifting, convert these to bar-ends with the pods below.

Silver DT Shifters: 17-101

Silver Pods!

These allow you to mount most downtube shifters as bar-end shifters. If you already have Silver DT shifters, or SunTour Sprints, you'll need these to convert them to bar-end shifters. These are neat and smart, and ours alone.

Silver Shifter Pods: 17-068

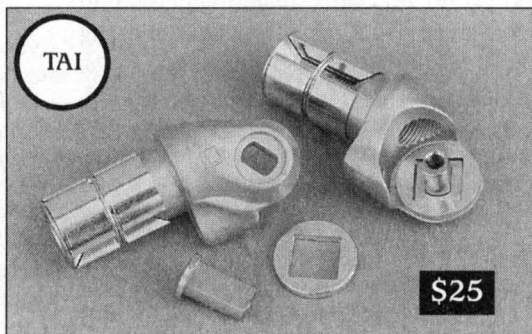

Friction Shifting in an Indexing World

Why do it at all, and the Best Way to Learn How

Why Do It At All

Friction shifting works with every derailleur, freewheel, cassette, and chain made. You can mix and not even match parts from different companies and different decades. It's liberating.

You have a direct link to the movement of the derailleur; and it's both easy and satisfying to do that. It's control.

Our survival as a company doesn't depend on our ability to persuade riders to shift in friction. But friction has a lot to offer, and is easy, so you ought to give it a try.

Don't you doubt your ability to shift without indexing. Riders did it for most of a century, with much worse derailleurs than we have now. My ten-year-old does it flawlessly, since she was eight that's her there in the photo.

The Best Way To Learn

1. Find a blank area and pedal in a medium gear. Any cadence.
2. Every two or three seconds, shift across the full range of cogs, not even stopping in between. Do that for a minute or so. Don't shift out of need, because there is none. Shift as though you're trying to wear out the shifters.
3. Try to mis-shift. If you successfully mis-shift, you'll hear the chain clicking and clacking between adjacent cogs. Once you do that, either push it back the way it came, or push it more the other way, until you're perfectly in a gear. That's called "trimming."

This intentional mis-shifting routine will show you that it's a lot easier to hit the gear than it is to miss it; and when you do miss it, it's easy to correct it. But

you'll be amazed at how infrequently you'll even need to trim the shift. I can't count the number of times I've found myself toting a load with one arm and having to shift with my foot (it's easier with downtube shifters than with bar-end shifters). Even with foot-shifting, I rarely have to trim.

The 1-2-3 Way to Shift on Hills

Shift before your pedaling gets really slow. With indexing, you can wait too long, pedal too slowly and the shift still takes. Whether you consider this a technological advancement or a quick way to learn bad habits, well, it just depends upon your approach to life. But that's the main difference between indexing and friction.



Impromptu double-shift by eight-year old Anna, who has used indexing but prefers friction...as does her big sister (and with no pressure from dad).

If you're grinding slowly up a hill and need to shift:

- 1) Point your bike across the road (traverse) to lessen the slope
- 2) Pedal hard for a stroke to get up a small bit of speed
- 3) Pedal lightly and shift.

It requires a small amount of skill, but the skill comes quickly and stays with you the rest of your life.

Neither Campagnolo Ergo nor Shimano STI shifters have a friction mode. They both work well, and if you love 'em, great. But their lack of a friction mode limits their use with out-of-series drivetrains, and makes them vulnerable to less-than-ideal conditions. And you can't shift either with your foot!

Downtube Cable Stops

When your bike has downtube shifter bosses (as all of ours and most others do) and you want to use something other than downtube shifters, then you need these cable stops to hold the housing. They slip right over the brazed-on stops and bolt on. Couldn't be easier, and there's no substitute for them. The stops we have are made either by SunTour or Shimano.

DT Cable Stops: 17-045

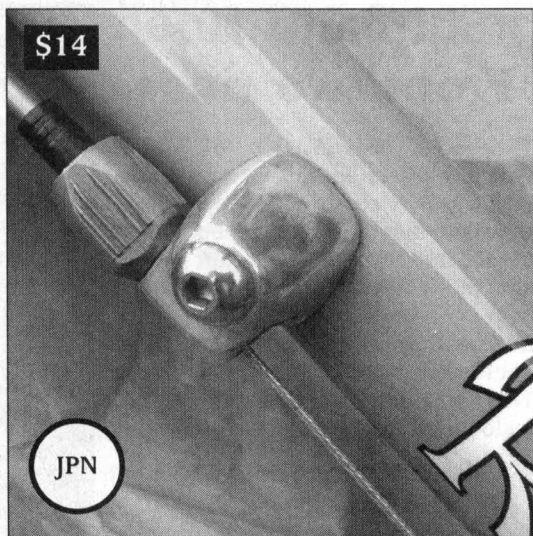

Shimano Bar-End Shifters

Shimano's best bar-end shifters, indexable with 8 or 9-speed cassettes, and with a friction mode, too. If later on you want to get our Silver shifters, you can just bolt them on to these and be happy. No need to buy any additional hardware. Great for touring, commuting, anything.

8-speed: 17-098

9-speed: 17-049

What They Don't Tell You About Shifting

Modern shifters are built right into the brake levers, and are sold on their convenience. Folks who like them often say, "Now I shift so much more often!" and the same folks say about their remotes: "Now I change channels so much more often!" If you had a straw full of milkshake in your mouth all day long, you'd drink milkshakes "so much more often." Convenience can take over, it can be distracting, and it can make you lazy. Absolutely, you should shift as often as you like and whenever it feels right, but there is satisfaction in grunting just a little to crest a hill, and there's refreshment to be found in pedaling both slower and faster than the textbook optimal range of 95 to 100 rpms.

For a lonely rider on a homely road, there's a case to be made for grunting five-percent harder or spinning four-percent faster to get past the harder or easier part. It's a more natural way to ride. Today's interest in single-speed riding is a backlash against more gears and ever-increasing pressure to shift at the slightest provocation. These riders find it liberating to not even have the option to shift. If you need a role model, there's Lon Haldeman. Lon has won RAAM a few times and continues to ride 15,000 miles or so a year by himself and with his PacTour groups, and rides a derailleurless bike with a single chainring and three cogs in back. He rides it everywhere, over all terrain. And there are thousands of others out there who, like Lon, have figured out that constant shifting isn't all it's cracked up to be. Bar-end shifters are plenty convenient, but just not too.

Shimano 105 Front/two rings

This is a masterpiece of value. Shimano's derailleur team is as crack-jack as they come, and many believe, as we do, that the 105 is the best value in the line. Nothing can shift better, and we've never seen one that looks better. At the subatomic level, there may be improvements in the Dura-Ace, but they ain't noticeable on a bike ride. This derailleur even works with a wide-range TA Cyclotourist triple.

Shimano 105 F. Der: 17-083

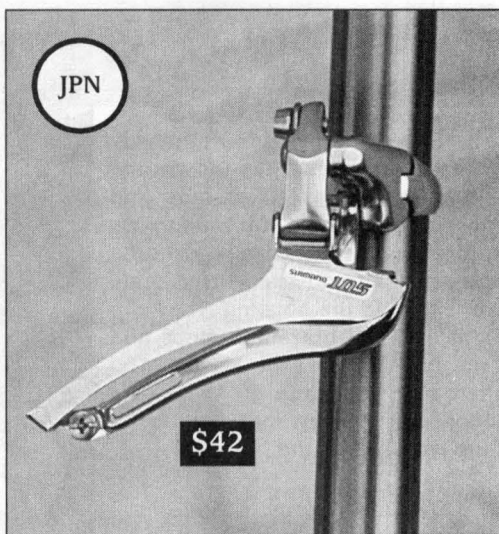

Shimano 105 Front/three rings

The same grade as the one above, but designed for three chain rings, just so long as those rings are separated by more than four teeth. The kinky-shaped inner cage, visible in the photo here, helps lift the chain during upshifts. Recommended for racing triples, with 48 tooth and larger big chain rings, but it works equally well on 26-inch wheel bikes with 46t big rings. For bikes with low bottom-brackets and sub-50t chain rings, this derailleur is better than the

current Dura-Ace triple. That one comes down too far and hits the chain stay sooner. No big deal if you're using it with either a 52t ring or a frame with a high bottom bracket, but low bottom brackets generally make a bike feel better, and 46t and 48t big rings are more usable than 52t rings.

105/3 F. Der: 17-082

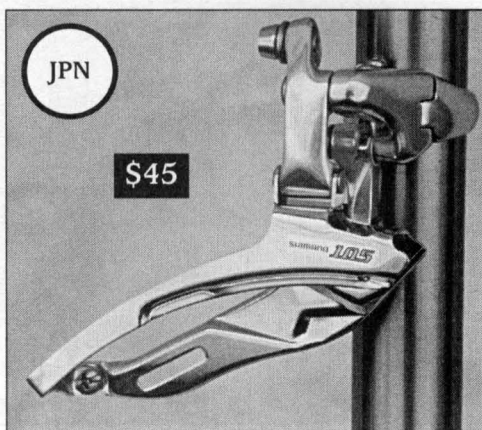

A Case For The Clamp-On Front Derailleur

The clamp-on style makes it easy to raise and lower your derailleur on the seat tube. This isn't something you have to do a lot, but if you've been pedaling around with a 53-tooth chain ring and finally decide you'd rather have a 46t or 48t big ring, a clamp-on style makes the change easy and good. On the other hand, if you have a brazed-on front derailleur, you won't be able to lower it enough to accommodate the new and smaller chain ring. You may have a \$3,000 frame on a \$5,000 bike, and you can't even ride the gearing you want to ride.

Before you get any new frame, think about this. Having a front derailleur braze-on offers no functional benefit, and absolutely limits your choice of chain rings. If you're getting a custom bike made, and you insist on a front-derailleur braze-on, then make sure the builder puts it in the right spot for the chain rings you're most likely to ride.

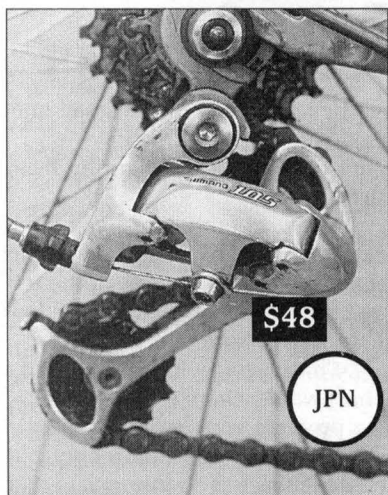

Shimano 105 Triple

For three chainrings and up to 28 teeth in back. This year's version is shiny silver, looks great, and given all that, it's hard to justify anything fancier and costlier. Shimano rates it to 27t in the rear, but it goes to 28t easily. Shimano's 105 parts group is the best value out there, and the derailleurs are the best part of it. We believe this is the top value in a road rear derailleur today. Beautifully styled, shiny and silver, and it shifts predictably and perfectly all the time. Prices went way up this year, but it's still worth it. If our price goes down, yours will too. It could happen.

Shimano 105 R. Triple: 17-059

Super long der. cable, each: 17-090, \$2

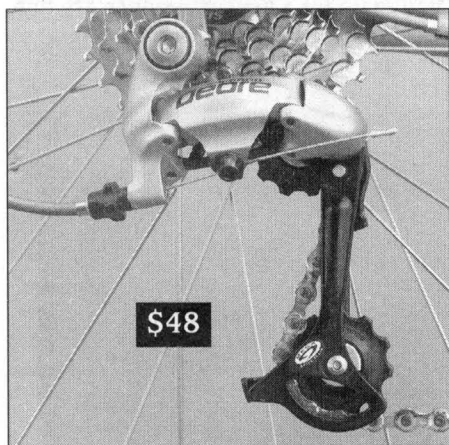

Shimano Deore

For rear cogs to 34 teeth, you won't find a better shifter than this one. Fancier and more expensive, yes, but not better. It's a strange champagne-y color and has a black cage. This is the model we put on most Rivendell All-Rounders and all Atlantis bikes. As with the 105, our price is as low as we can go, but you might beat it at one of the cheap places.

Shimano Deore: 17-088

Super long der cable: 17-090, \$2

Pricing Rear Derailleurs

Savvy penny-pinchers can find the two rear derailleurs on this page for a lot less from Nashbar and Excel Sports, to name two. I don't know how they get them so cheap. We can't buy them any cheaper than we are, and nobody's screwing us with the price. But it presents us with a dilemma, anyway. Do we match prices and lose money, or not even carry this or that derailleur because somebody else can sell it so much cheaper? I don't think there's an incredibly good answer to that question, but ultimately we've opted to stock them and take a non-sustainable profit on them (mark them up less than we need to keep the business going), because the idea of not carrying something because somebody else carries it is more distasteful than a too low price.

We hope this doesn't continue. Your local bike shop, by the way, faces the same thing we do. We buy certain parts, like rear derailleurs, from the same sources and at the same prices. We want your business, your local bike shop wants your business, and the guys who can sell these cheaper than dirt also want your business. Whatchagonna do?

Is Backwards Better?

The rear derailleur at the bottom of this page looks normal, but works oppositely—meaning, the pulleys are relaxed when they're below the large cog, not the small one. Shimano calls this feature "Rapid Rise."

Shimano's reasons for RR is that it's more logical and easier to learn. Starting from scratch, that's indisputable, because it is more intuitive.

It makes the most sense with bar-end or down-tube shifters. In both cases, you push the left and right shifters forward to get an easier gear in front or back, and pull them back to get harder gears. The way it is now, with a standard derailleur, you push the left lever forward to get the low gear in front, and pull the right lever back to get the low gear in back. It isn't as logical or intuitive, but you learn it over time.

But it's still illogical. If you're new or newish to riding, I'd say start with RR and don't look back. If you've always felt the normal way was backwards, change!

Many of you have learned the other way, and have no problem with it. You have little to gain by changing, but less to lose by it than you think. You will mis-shift plenty, but your head doesn't blow up when that happens, and the feedback is so immediate that you correct it right away without missing a stroke. It took me about a month of increasingly rare and always inconsequential mis-shifts before I reached the point where I hardly ever mis-shifted, and now I prefer it. If you're up for a new experience, try one. You don't often get an opportunity for such a restart on something that's become so familiar. Rapid Rise derailleurs won't take over, but they make more sense. —Grant

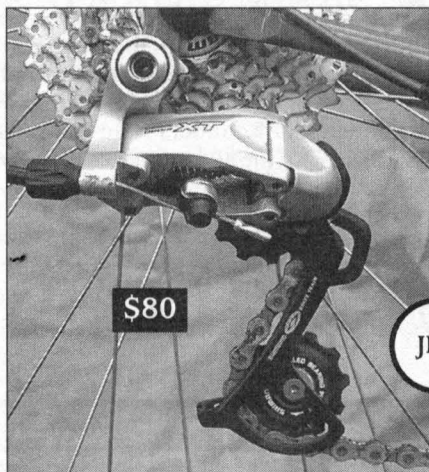

XT Short cage RapidRise: 17-117

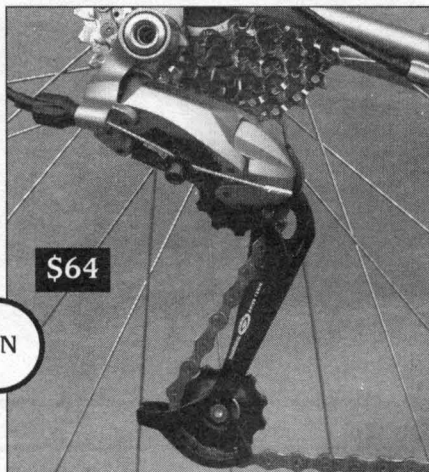

LX Long cage RapidRise: 17-119

JPN

Which One To Get (all about chain wrap)

Similarities: They both shift up to 34 in the rear. They both work great. They'll both last several years or one rock, whichever comes first, and they both look fine.

Differences: The short-cage XT won't "wrap" as much chain, so if you ride in the small front ring (say, a 24t) and a tiny rear cog (less than 18t or so), the chain will be slack, and that's not good. It's not the kind of thing that'll jack you off the bike, but it might make you lose you composure, and conceivably that could lead to new bridgework. But, if you can limit your small chainring use to the four larges rear cogs in the cassette, it's fine—and you get more ground clearance.

Here's how to figure out what you need: Subtract the number of teeth in your small chainring from your big front ring. That's X. Then subtract the smallest rear cog that you'll use with the small ring from the largest rear cog. That's Y. If $X + Y = 33$ or less, you can get the XT shorty. If it's more than 33t but less than 46t, get the LX longy.

Example: Crank has 48x36x26 rings. Rear cogs are 11x32. Okay now: $48 - 26 = 22$. And $32 - 11 = 21$. Since $22 + 21 = 43t$, go with the LX. BUT if you can limit your 26t chainring to a 21 or bigger cog, then $32 - 21 = 11$, and $22 + 11 = 33$ —presto, you can use the XT.

Phil Wood BB

This model has the benefit of about 27 years of evolution and refinement. It is machined from 17-4 stainless, a better and more expensive material than most others use, and once installed into a frame, you'll likely get 25,000 miles on it. When it needs servicing, send it back to Phil, and they'll do it for cheap—about \$20 to \$25. You also need the retaining rings (below), and a tool (way below) to install it with. Two tools make it easier, so get two. Other sizes available on special order. Call first.



Install It the Easy Way
Grease the shoulders, where the retaining rings fit on, and pre-install one side before inserting it into the frame. The red ring goes on the right.

108: 12-045

119: 12-050

123: 12-051

125: 12-140

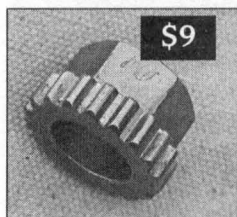

Phil tool: 19-035

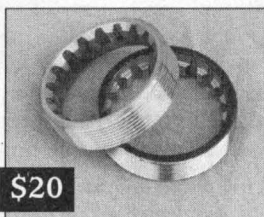

British \$20: 12-053

Italian \$20: 12-054

Phil Tool & Rings

These screw into your frame and hold the Phil bottom bracket in place. We list British only, for American and Japanese and most non-Italian frames, but usually have Italian ones in stock (call).

Shimano or Tange BB

An excellent, trouble-free bottom bracket and a great value. It installs easily, is sealed, and you'll likely get 15,000 miles out of it. We can't say they'll work for sure with a crank you have...but if it's a Japanese crank with a square taper and the current spindle seems about the same length as the ones here, it's a good bet. We can say for sure that they work great with the Sugino XD-2. Sizing:



Road bikes with two chainrings and no bowed-out chainstays: 107mm.

Road bikes with three chainrings and no bowed-out chainstays: 110mm

Any bike with bowed-out, but not ultra bowed-out chainstays: 113mm

107: 12-191

110: 12-192

113: 12-254

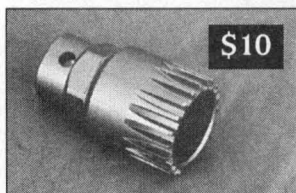

BB Tool for Shimano

This tool here fits into the recessed splines of the UN-72 and UN-52 and other Shimano bottom brackets so you can install, tighten, or remove it. You can use a big adjustable wrench on it, or ratcheting socket wrench.

BB Tool for Shimano: 19-055

Crank Design and Gearing

Why Off-the-Shelf Road Gearing is All Messed Up; and a Solution That Probably Won't Be Adopted

Off-the-shelf road bike gearing, with a 52 or 53-tooth big ring and an 11t or 12t small rear cog, gives you a high gear of 117+ inches. If you don't race or if you don't have Charles Atlas-like muscles, that's astoundingly not useful. Even worse, the big ring makes subsequent gears less useful, too. It's not smart and it's not right. Manufacturers aren't dumb, they're just "market-driven." They continue to sell such high gearing because it sells. It doesn't sell because it's smart, it sells because there are no alternatives. The big bike makers are equally market-driven, and on top of that, are—for the most part—scared to be different. *Different* scares dealers.

It's a sad cycle and it makes thinking folks shudder. Listen: If you ride alone or with friends who don't aim to drop you, then a 46x12 or 13 (top gear of 95 to 104 inches) is way more useful.

The smaller big ring lowers your top gear, so you'll "run out of top gear" earlier. But it also lowers all adjacent gears, so you'll stay in them longer before having to shift, which is way more important. It's especially noticeable on rolling hills. With a normal "racing triple"—52x42x30—you can't stay in the big ring on a slight uphill. But when your big ring is a 46 (or even 48), it's not so hard. Likewise when you're in the middle ring. Many racing triples have 23-tooth large rear cogs, and a 42x23 is still a pretty big 49-inch gear. A 36x23 gives a 42-inch gear, and you'll often find that the difference between having to shift to the granny, and being able to ride it out in the middle ring.

The benefits of a 46x36x24 "compact" racing triple are numerous, and for the non-racer, there are no drawbacks whatsoever. Repeat: *No drawbacks whatsoever.*

Both Campy and Shimano ought to introduce a 110x74 triple. If they want to keep the big rings, fine—but the smaller, 110mm bolt pattern will at least let riders change to more useful rings, like 48x36x26, or 46x36x24. Call it the "alpine gruppo" to give it a marketable spin or whatever—but do it. It's years overdue.

What would such a crank involve? Well, a new front derailleur. Current "racing triple" front derailleurs work okay, but they're designed to be used with big rings, and are radiused to follow the bigger radius of the big ring. Plus, they're too long in the tail. When you set them up properly on a 46-tooth ring, the lower "tail" hits the chain stay when you shift to the granny. (Unless the bike has a high bottom bracket, which itself is not good.) So: Make the crank, and make a new front derailleur for it. Curiously, the Shimano 105 triple is better designed than the fancy Dura-Ace triple, which sticks down way too far. It cannot be used with a 48t or smaller big ring on a road bike with a decently low bottom bracket. It forces you to use a 50t or larger chain ring.

Next, if they want to do a real bang-up job, make compatible cassettes with at least 28-tooth big cogs, and even better, 32t. The larger cogs would require a mountain rear derailleur, and there's no way Shimano (for example) is going to intro a new group with a mountain derailleur. But they could polish up or paint differently a Deore derailleur and call it something else. There's nothing wrong with that and it wouldn't be the first time...

Recently some famous pros have used 110bcd cranks in mountain stages of the Tour. That may be the impetus needed. Smaller makers are re-introducing the 110bcd crank (remember, that's the size needed to use the useful rings). That's another nudge for Shimano and Campy. But include a 74mm bolt pattern for smaller rings, too.

Currently, the Sugino XD triple is the smartest widely available road triple on the market, and is far and away the best value. TA used to make the Zephyr, but they've quit that, for some sad reason. It's the Curse of Being Market-Driven.

Let's see what happens in the future. Will Campy make it a 112mm bolt pattern, just so it's incompatible with all the billions of 110mm rings still available? Will Shimano somehow fuse the rings to the crank so it's incompatible with existing 110mm chain rings? We'll see. Something's got to change, though. The current state is not good.—GP

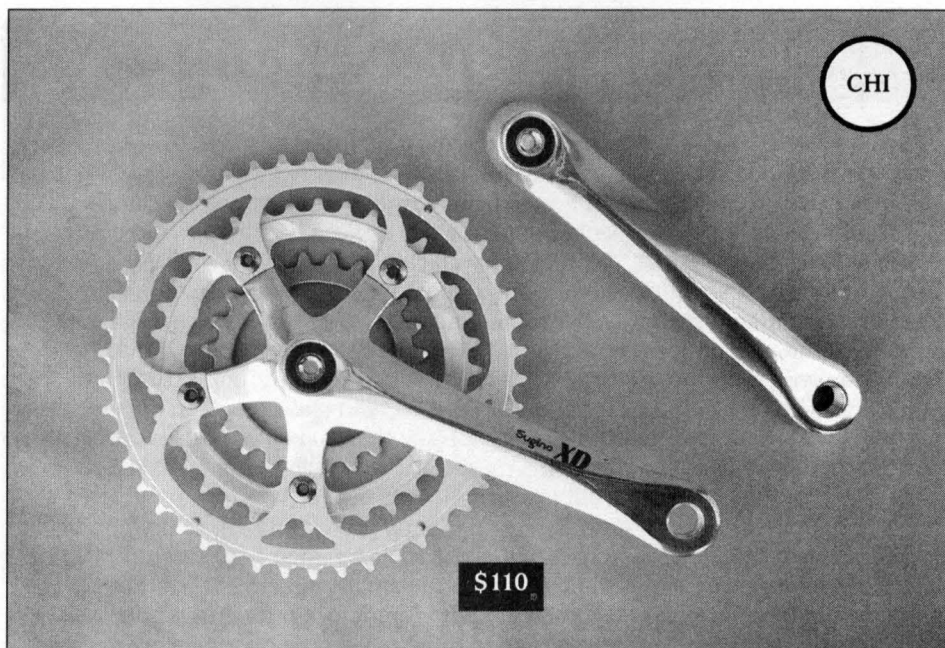

Sugino XD2 Triple: The best value ever in a triple crank

This is the smartest and most versatile triple crank on the market, and is almost too smart and all-around good to even exist in these weirdo times. It's possible that Sugino wishes it could wipe it out with a new "modern-style" crank, but hasn't the resources to do that yet. So for now, everybody with a decent job should dig deep and buy at least two of them, just to encourage Sugino to keep making it.

It has about a 161mm to 165mm Q Factor (outside-to-outside width), depending on what length spindle you mount it. In the old days we'd consider that wide, but by modern standards it's smack dab medium. On road bikes with straight (normal) chain stays, mount it on a 107 to 110mm bb. If your bike has bowed-out chain stays like most mountain bikes, it'll need a 113mm. Unlike most cranks, it also comes in a 165mm arm length. At only \$110, it is a shocking deal. 110/74 bolt circle design with 46x36x24 rings.

165mm: 12-231

170mm: 12-167

175mm: 12-190

How Long the Cranks?

In the pre-mountain bike days, no crank maker in the world would think of NOT offering cranks in lengths down to 165mm; and 2.5mm crank length increments were standard on better cranks. Today, probably 90 percent of the cranks available come in 170mm and 175mm only, and those large makers in a position to demand a wider range don't see the need. They should be ashamed.

You might think that the crank makers would offer it, but they don't make what there's no demand for. What's involved in another crank length? Not much. A new mold costs about \$10,000, and the same mold can work for a 5mm to 10mm difference in length, just by drilling the pedal hole in a different spot. It wouldn't be right to whine without noting the exceptions: Campagnolo, Shimano Ultegra and Dura-Ace, TA, and this Sugino come to mind. It's unlikely that the shortage of shorter cranks will continue. Common sense ought to win sometime!

Tips For Happy Riding

Learn right away that the front brake is the most effective one, and to never lock the front wheel in dirt. Learn how far you can lean over without scraping a pedal. Learn to keep the inside pedal UP when you corner, and learn to ride safely in all conditions. Signal your approach to pedestrians, especially if they're old, and a bell is better than "On your left!" If no bell, try clacking your brake levers. If all you got is "On your left!" that's fine. At least one ride in 10, go without your sunglasses and gloves. Sometime next month, put some double-sided cheap-style pedals on a good bike and ride in non-cycling garb. Carry an extra tube you can donate to somebody with a flat tire and just a repair kit. If you're a guy, don't try to be a mentor to every female cyclist you meet. Don't ride in shoes you can't walk through an antique shop in. Don't wear clothing that makes your sweat stink even more. Don't think you'll go faster in a significant way if you and your bike become more aerodynamic. Put a \$20 bill inside your seat post or handlebar and hold it there, somehow. Don't ride until you're confident you can fix a flat. If you ride more than one bike, have a set of bring-along tools for each one. Learn how to remove your rear wheel (put the chain onto the small cog, etc.). If you ride in a group, bring food for you and somebody who forgot to. Go for a one-hour ride underdressed sometime, because it's good to be really cold on a bike every now and then. Never blame your bike or your health or anything else if you're the last one up the hill or in to the rest stop. If your brake hoods are black, wrap your bars with a different color tape. Never let your chain squeak. If you pass another rider going up a hill, say more than "Hi." If you see another rider approaching you from the rear, trying to catch you, let it happen. Fun is more important than fast. Don't put any cyclist up on a pedestal, except Lon and Freddie. Sometimes, bring normal food on your ride. Shoot photos on your rides and give them away. Feel comfortable mixing high tech and low tech, old and new parts and technologies, and don't apologize to anybody for it. Compliment other people's bikes, especially if they're new. Buy the cheapest helmet that fits well. Try seersucker shirts for hot weather riding, and long-sleeved ones are best. Don't underestimate fig bars. If you get a new widget and like it, don't "swear by it." Don't always shop by price and never ask for discounts at your local bike shop. Every time you go into a bike shop, spend at least \$2, and if you ask a question and get good advice, spend \$5 (get a cable). If you buy a rack, don't ask for free installation. Don't assume your bike shop is making money. Ride only when you feel like it. If you know a fast new rider, don't say, "You really ought to race ..." If you see a stocky woman rider, don't suggest she race track. Have at least one bike you feel comfortable riding in a downpour. Ride in weather that keeps other cyclists indoors. Never keep track of your pedaling cadence. If you have a normal loop or ride, count the number of times you shift on it; then the next time you ride it, cut that in half and see if it makes any difference. Learn to ride no-hands and to hop over obstacles, but not simultaneously. Never hit a pedestrian. In traffic, be visible and predictable. If you have several bikes, set them up with different equipment ... but always ride the saddle you like best. Don't try to keep up with faster descenders if you're not comfortable descending. Never apologize for buying something that's not quite pro quality by saying, "I'm not going to race or anything." If you buy a stock bike, do something to it that makes it the only one exactly like it in the world. Don't think it's important to match front and rear hubs or rims. If you borrow somebody else's bike, for a short test or a long ride, say something nice about it. Always bring a pump. Build at least one wheel. Wear out something. Don't ever describe any bike, no matter how inexpensive or dilapidated, as "a piece of crap." If you get a fancy bike assembled by somebody else, allow them a scrape or two, especially if the bike is really expensive.

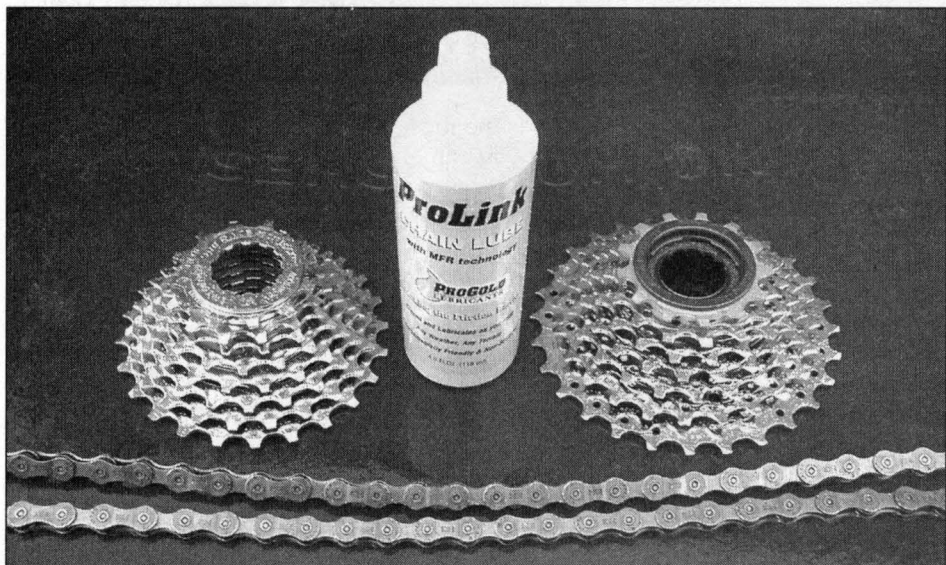

Cassettes, Freewheels, Chains, Lube

These are the down & dirty parts of a bike, and there's no use lusting after them or going to Great Lengths to acquire The Perfect One. For non-competitive riding, just decide between freewheel and cassette, then pick a gear range you can live with, and then get a chain you like the looks of and can afford. Our selection here is small, and may not make the manufacturers happy, but it makes choosing easy, so you can get on to other matters. When possible, we have Shimano chains in either silver or silver/black combos. Cassettes are Shimano-compatible, but not always Shimano. They're always good, reputable, respectable, etc., but if you need to have a certain brand, call first.

As for chain lubes, there's no need to use anything besides ProLink. It treats the metal to resist wear, it lubricates, it doesn't get all black, and it's cheap. The best we've used.

8sp cassettes: 12x24 : 13-048 11x28: 13-049 11x32:13-041 — \$30

9sp12x27:13-064 — \$55

Chains: 7/8sp: 13-047 (\$15); 9sp: 13-031 (\$21)

ProLink chain lube: 13-051 (\$6)

It's Time to Get a New Chain When ...

...you can grab a fingerfull of chain from the chain ring, pull it off, and expose the tip of a tooth. Or when you can't remember the last time you got a new chain, but you just got a new freewheel or cassette. Chains wear over time, and the hole-to-hole distance increases, "stretching" the chain. If you put a stretched chain on a new set of cogs, it won't work well, and will start wearing out the cogs right away. For most riders, a new chain every 1,000 to 1,500 miles helps the cogs last longer. There are chain-wear indicator tools you can buy, and we wouldn't discourage you from being so conscientious, but they aren't totally necessary.

• No. 15 Winter '04 - '05 •



\$36

JPN

MKS Touring

Our most versatile pedal, and most popular one, too. It's wide, so it supports your foot. It grips shoes, it's easy to flip into, you can ride on both sides, it's great in mud, it works great with or without toe clips, and with almost any shoe, from sandals to Sorels. For commuting, it's ideal. For distance riding, where shifting your feet around can be useful, it's great. You will adore this pedal.

MKS Touring: 14-020

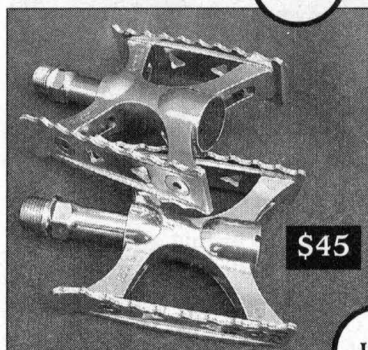

\$45

JPN

MKS Fancy Touring

Like the pedals above, but at 308g per pair, lighter by 72g; and with a shorter cage for better cornering clearance. We had MKS do that just for us. So if you pedal around corners or tend to be careless, get this one instead. Also made by MKS, with the custom shorter cage (for more ground clearance!!!!)

MKS Fancy Touring: 14-048

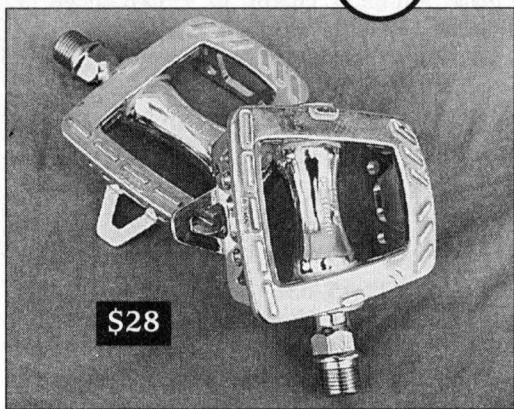

\$28

MKS Platform

The platform provides plenty of support and distributes the pedal pressure, so you'll ride comfortably up steep hills and over long miles in anything from Acorn slippers to bona fide cycling shoes. They're made to be used with toe clips (not shown), and the low rear cage and the big flipper tab make them a cinch to flip into. At \$28/pair, a write-home-to-mom-about deal.

MKS Platform: 14-030

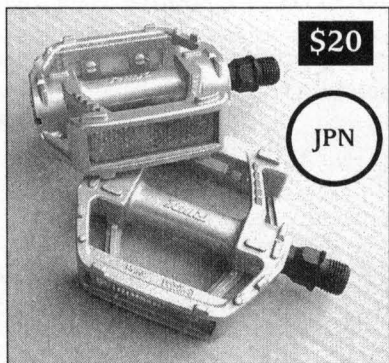

\$20

JPN

MKS Sneaker Pedals

All of our pedals are inexpensive and good—try them and see what you like best, or ride a variety. These made the cut because they're extra supportive and good with sneakers; AND they have built-in reflectors, so even if you forget your lights or ankle bands, you're still visible and identifiable as a rider. Most of us here have them on at least one bike. What a bargain—only \$20. That's nothing! You will absolutely like them. And cheap!

MKS Sneaker Pedals: 14-047



Going Clipless (Rivendell Style)

Most of the time, having your foot attached to the pedal is no real benefit. It's said to be more efficient, and all I can say to that is: Maybe a little, but so what? Certainly, if pedaling connected made a difference of five minutes per hour of riding, then for certain types of riding (including long commutes) that alone would pay its way. But my hunch, based on my own tests, is that it makes no more than a few seconds difference. This goes against all intuition and what you've been raised to believe, but just try it yourself. Most riders have tried "step-on" pedals only on the bike they had before they "got serious." They have cheap-slow-heavy associations with that kind of pedal, but have never tried it on a good bike. That's where it really shines, though!

On short, steep climbs, a solid connection can help you turn the pedals over, to get them through the difficult spot between 10:30 and 1:30 in your stroke, when you about lose all your momentum. A solid connection can be a benefit during aggressive riding in wet weather, because it keeps your foot from slipping off the pedal (remember, it's wet and you're thrashing). For most people, that constitutes about 10 percent of the riding, maximum. Also, riding unconnected means you can't as easily hop over dead animals and potholes. That's a semi-biggie, but even when I throw that into the mix, I still prefer No Connection.

Pedaling free works great for most riding. You can mount and dismount more easily, whether on a steep climb or downtown. You can choose your shoes for the weather, not the pedals. You can walk into a store like a normal person. You can shift your foot on the pedal to call to action different leg muscles.

That last one's a biggie, and Bullseye Cycle's Roger Durham pointed it out to me, after I'd already experienced it. When you pedal with the ball of your foot over the center of the pedal, you're using what Roger (never the physiologist) calls "toe muscles," or the muscles you use when you stand on your toes. Not just the foot and calf muscles, but the thigh muscles, too. Roger goes on to say, and I now agree, that on sustained climbs, it's a benefit to be able to shift your foot forward on the pedal, to relax the toe muscles and put the load onto others for a while. It helps to have a fairly rigid sole for this. A Teva sandal is good enough, or a court shoe.

Forget what you've read or been told. Forget even this. Just try it and see how it works for you. You don't have to discard your rigid plastic shoes, or your toe clips and straps. Just try pedaling free again—on a good bike, so it's a fair test—and you'll likely find a place for it somewhere in your riding. If you've got more than one good bike, keep double-sided pedals on one of them, and see how often you end up grabbing that one as you head out the door. —GP

Steel Toe Clips

Christophe of France finally quit making chromed steel toe clips, and then ALE of Italy thought, "Hey, maybe Christophe is onto something" and followed suit. The trend hasn't made it to the east yet, so we're still able to source these from MKS of Japan. I expect they'll quit making them within 5 years; it's just the way things go.

Bend the upper part to fit your instep, and you're all set for toe clips for the next 20 years or so. They won't break.

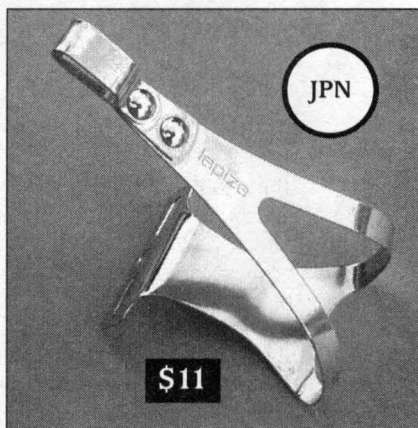

S: 14-015

M: 14-014

L: 14-013

XL: 14-016

ALE Toe Straps

Plain, non-laminated full-grain leather with buckle pad, to increase comfort just slightly if you have them cinched too tight; and to add classy looks and protect classy shoes.

We used to sell both plain and laminated straps, but laminated straps are mainly for track competition (the laminated decreases stretch, so you don't pull out of the pedal at the start of your kilo)—and modern-day track riders who still use toe straps will now have to fend for themselves. The plain ones work fine for all practical toe-strap uses, so that's what we got. Blue.



14-044

Power Grips

The most underrated bicycle accessory on this or any other planet. Originally marketed for people who were afraid of toe clips, they naturally repelled, and continue to repel, experienced gear snobs. But they are a joy to use. They keep your foot on the pedal at all times, and make quick exits and re-entries a breeze. For most of the riding we do, they're just great. They let you ride in any shoe you like, and still allow 90 percent of the freedom of nothing at all. We mount them inside out, to hide the logo. But everybody knows it's a Power Grip, because nobody makes anything else like it at all. We'll try to stock blue, but please accept green or black.

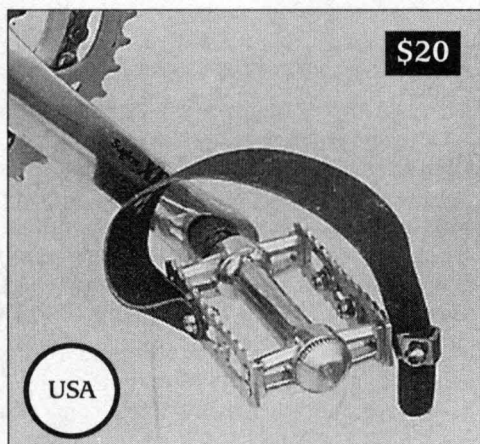

Power Grips: 14-046

Shimano Ultegra 57mm Reach Sidepulls

These are the brakes that go on most Rivendell road frames, and as sidepulls go, man, you can resent Shimano's dominance and prefer the aesthetics of an old Campy till the cows come home, but when you're juiced up with truth serum and you're faced with a choice of sidepull brakes based on function, these are what you'll end up with.

The Ultegra has a slightly better finish than the Tiagra (Shimano's other standard reach caliper), as well as a real metal barrel adjuster and shoe holders, and thrust bearings in the pivots, for theoretically smoother braking. These work best with sprung (like Shimano) levers. Minimum reach, 47mm; maximum, 57mm.

Ultegra Std Reach Sidepulls: 15-094



Dia-Compe 505Q

For those of you who truly don't have an ounce of snobbishness in you, and who only want perfectly good, lightweight standard-reach sidepull brakes—probably to retrofit an older bike, or to shock your friends when they show up on your new Rivendell—we offer these. Cold-forged. Adequately finished. Ugly brake shoes (but you can change them). How do they work? Just fine. Truly the best value in a road brake, in the whole universe.

Dia-Compe 505Q: 15-081

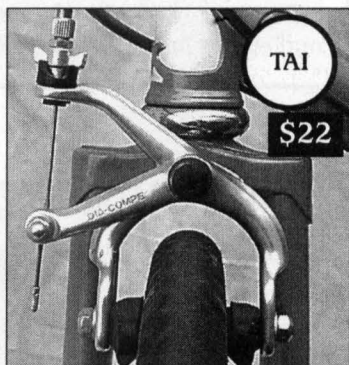

Tektro Oryx Cantilevers



Tektro is a Taiwan company that makes pretty good-to-excellent brakes, and this is the canti model we like. It's a simple design and seems good and powerful, and the brake shoes, heavens, are so, so easy to set up and adjust because they use a ball-and-socket arrangement. The way most V-brakes are.

These are cold-forged and decently finished, and work well with every brake lever we offer in this catalogue.

Tektro Oryx Cantilevers: 15-098

Brake Design and Brake Issues and the Future

The Dia-Compe Mod. 750 centerpull brake shown below has the highest function-to-respect ratio of any brake in this catalogue, and likely any brake made today. Centerpulls are so out of fashion, and have been so out of fashion for so long that old riders associate them with early-the first bad bike they ever had; and new riders don't know what to think about them. There are good reasons to like them...

They're easy to set up. They provide lots of tire clearance. The arches are shaped to accept fenders. They work well. The action is a little heavier than the faerie-weight action of a Shimano brake, but I put them on my bike and forget they're there; they just work. The brake shoes that come with these are not great, so get some Mathausers or Kool Stop salmons, or some other better shoe. The reach is an issue. These have a minimum reach of 62mm and a maximum reach of 78mm, so you can't just retrofit your modern road bike with them, because they won't meet the rim. These brakes are ideal for bikes designed for mid-to-large sized road bikes with fenders (that smart thinking went into lots of the old cheap bikes), and we make a tourish frame called the Saluki that these work great on. It would be neat if other brake makers would see the good points of centerpulls and remake them in a variety of reaches, but most modern parts makers are too image-conscious to risk that.—Grant

Dia-Comp Mod. 750 Centerpulls

If you've been riding bikes forever, you still haven't seen these new in at least 25 years; but these are new, made just last year. And, if you're newer than that to bikes, you may never have seen or noticed them.

Well...they're back and we like them. We won't sell many of them—that would require an all-out campaign, and we haven't the time. But they beat sidepulls in clearance, they stop you just fine, and they have symmetry that not only looks good, but works great. The minimum reach is 63mm, so they won't fit on most bikes, but if you have an older road bike with lots of clearance OR are thinking about a Saluki, these are an excellent choice. Don't just dive into them; know they're right for your bike, first. Front allen, rear nutted (with allen filler for the bridge).

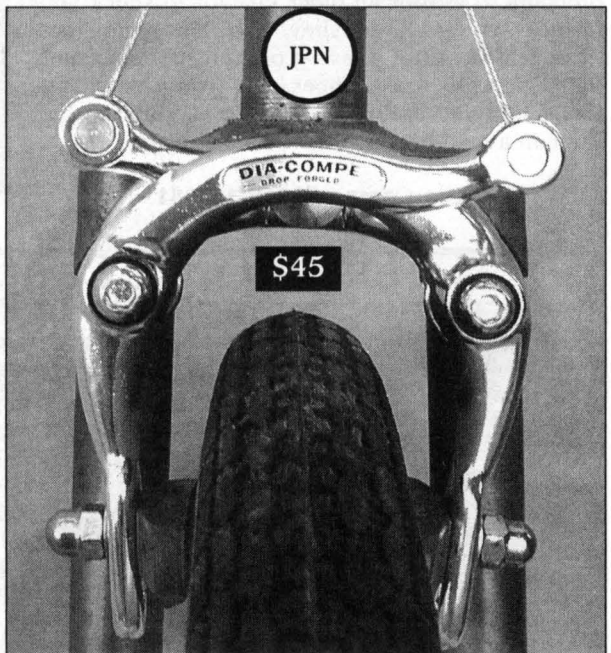

Dia-Compe Mod. 750 centerpulls: 15-119

Dia-Compe 204Q

A new lever, but a resurrected style that was resurrected (and improved upon) due to demand from the Japanese traditionalist market. It's a non-aero lever with a quick-release built into the lever.

Before you say "so what, I've seen it before," listen: It means you can use an inflated chubby tire on a relatively skinny rim, and still open up the levers far enough to remove and install a wheel. It gives you another five mm of clearance at the brake shoes. You don't have to take the air out to mount your bike onto your roof rack, and you can fix a flat and inflate the tire off the bike, too. The lever feels good in the hand, looks fine, and is dirt cheap. A great deal!

Dia-Compe 204Q: 15-101

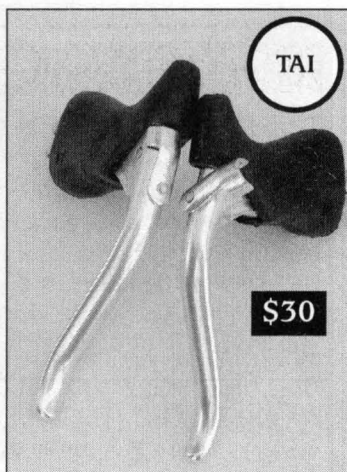

Brown hoods!

Shimano Tiagra Lever

This lever has 90 percent of the looks and quality of the aero Dura-Ace model, but costs 60 percent as much. As aero levers come, they don't get any easier than these; and the grip size and shape is eerily perfect for every hand on earth. The only blatantly cheap thing is the plastic whatchamacallit between the rubber hood and the lever. It doesn't do any harm, and it doesn't look bad, but it is plastic nonetheless. Forget about it—if you want nice aero brake levers that you'll love the instant you put your hands on them, get these.

Shimano Tiagra Lever: 15-091

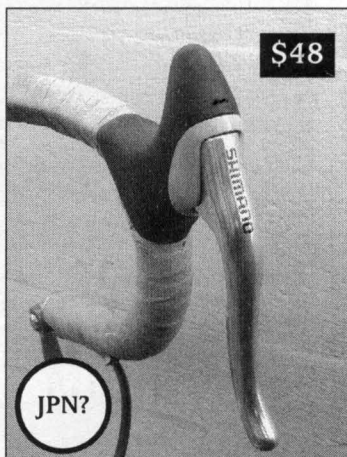

Tektro Cyclo-X Levers

These are designed for cyclo-cross racers, and they work for everyday riding, too. Whether you want to complicate your handlebars is another matter...but the fact is, these are quite nifty. You still have

your regular brake levers, and one set of cables, but both your normals and these "interrupters" work the brakes. It's hard to explain, but in real life it's simple, so if you're nervous, don't be. This isn't the dream set-up if you ride with a handlebar bag, but not all bikes wear bar bags, and if you've got one that doesn't, and you ride it either in town or off road a lot, and/or your handlebar is too low anyway, then these are just the ticket. A hinged clamp makes them go on easy. Instructions included, too.

Tektro Cyclo-Cross Levers: 15-109

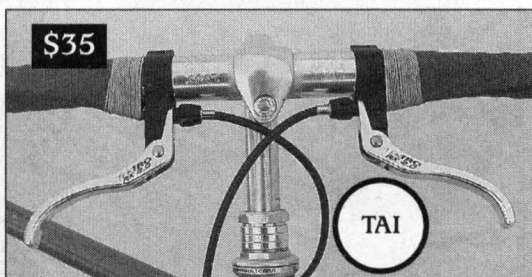

Learn Your Pubic Bone Height (PBH). Here's How To Measure It.

Squeamish people call it “inseam,” but pants have inseams and bodies don't. What we're after, truly, is the height of your pubic bone. From this you can derive what your saddle height ought to be (within five mm or so). And PBH is a key measurement we use to design a frame. It's easy to measure, and if you're reading this catalogue, it's a good indication that you're deep enough into bikes that you ought to know yours. Here's how to do it.

- You will need:**
- two paint stirring sticks, rulers, or a thin hardcover book.
 - A metal tape, and you might as well make it metric.
 - An honest, helpful person with good vision. (Note: It is not necessary that this person be a friend.)
 - Bare feet and a hard floor

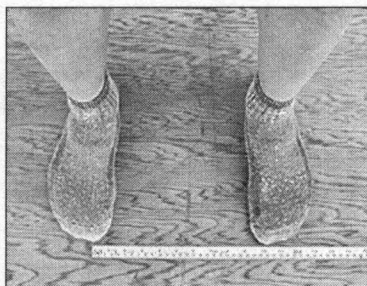

On the hard surface, stand with your feet about 10-inches apart. Plus or minus an inch.

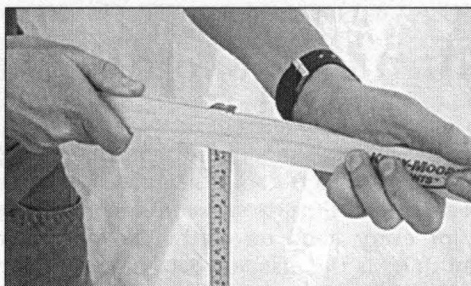

Sandwich the tape between the stirring sticks. Then call your helper, because from this point on, you can't do it accurately by yourself.

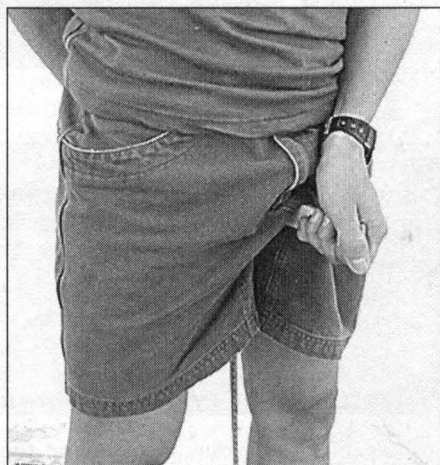

With one hand in front and one behind, pull up **HARD** on the sticks, past the soft tissue, until you hit bone. If you're chubby, you may not make it all the way to bone, but try.

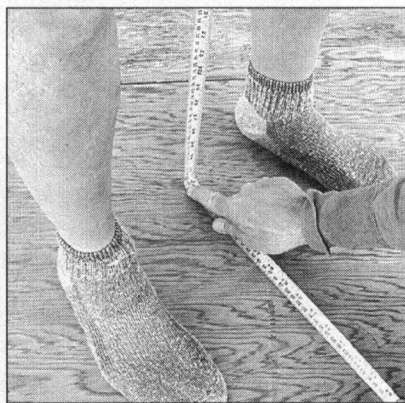

Your helper (see above) should make sure the tape is straight. Once it is, that same person reads the tape on the hard surface. That's your PBH. As long as the tape is straight, you cannot overmeasure your PBH. If you do this procedure 10 times, the highest reading will be the most accurate.

Finding Your Right Saddle Height (SH) from your Pubic Bone Height (PBH); and Once You've Got That, Picking a Good Frame Size

There are lots of ways and systems and approaches to figuring out the best size for you, and then setting it up (with stem height, extension, saddle height and fore-aft position, and so on). There's the LeMond Way, the Guimard Way, the Fit Kit Way, the Size Cycle Way, the Local Guru Way, the Ask a Fast Guy Way, the Chat Room Way, the Way You've Always Done It Way.

Certain funny bike styles may require a different way. But for normal bikes, the way we do it works well all the time, and it's simple, and you can do it with a friend using things you have laying around the house.

$$\text{SH} = \text{PBH} \text{ minus } 10 \text{ to } 10.5\text{cm.}$$

Qualifiers: Thick-soled shoes and Look pedals require a higher saddle.

What to look for when it's right: A slight bend in your knee when your pedal's at the bottom of the stroke and your foot is horizontal. No rocking side-to-side when you pedal.

Think About This When Picking a Frame Size

1. You must be able to straddle the bike's top tube with an inch or so of clearance. For trail bikes, two inches is probably better—although the arguments for that aren't so solid. Tall people always get more clearance than short people; it's no better or worse, it's just a fact.
2. Visuals and role modeling affect our perception of what looks good. Up to the early '70s, "a fistfull of seat post" was the rule—the idea being that if you need more than that, your frame's too small, sucker. These days, "compact" style road frames and long seat posts are so common, that anybody who pays attention to magazines and what fashion-conscious cyclers ride is used to seeing two fists of post or more.
3. Want to be comfortable? Get the biggest bike you can straddle with sufficient clearance. This suggestion will make modernists howl, but it's no less valid for it, and here's why: The higher your bar is, the less stress there is on your back, neck, arms, and hands. The bigger the bike, the easier it will be to get the bar higher. If you're deciding between a 58 and a 60, for instance, keep in mind that your saddle height will be the same with either bike, but you'll be able to get the bars almost two cm higher on the 60, all else being equal.
4. Flexible and skinny riders can comfortably ride lower bars than can heavy and stiff riders. But higher bars won't make you heavy/stiff, and low bars won't make you flexible and skinny.
5. A bar with rise (like the Albatross), or a tall stem can compensate for a frame that's a bit small. You may not need a whole new bike...
6. A general rule: For riders over 6' 3", PBH minus 27 to 29 is a ballpark frame size. For riders between 5' 11" and 6' 3", PBH minus 26 to 27; between 5' 8" and 5' 11", PBH minus 25 to 26. Up to 5' 8", PBH minus 24 to 25. All this is in centimeters. Get a tape with metric and standard.

Dia-Compe Canti Shoes

The rubber isn't as grippy as Mathauser rubber (also known as Kool Stop Salmon). But grippiness isn't absolutely totally completely everything in brake shoes, and where Mathausers leave off, these take up. For instance: The shoes are curved to follow the rim (good). They don't have quite the tendency to squeal when things aren't just perfect (also good). They grip plenty good, even for steep descents. They won't last as long as Mathausers, and at some point Mathausers will edge ahead under extreme circumstances, but overall, these are super shoes, and slightly easier to live with than the M-brand. Made in Japan. Grey. These are great shoes, really cheap.

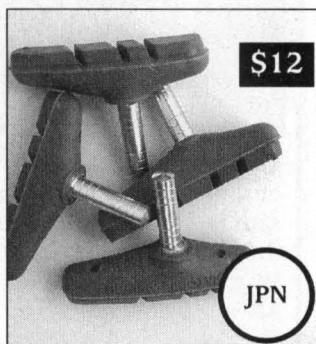

Dia-Compe Canti Shoes: 15-113



Mathausers

More likely to squeal if you don't set them up right, and not curved nicely to fit the rim, but if you need the highest friction brakes for extended loaded touring or steep trails, these are the best choice. The hardware is crude,

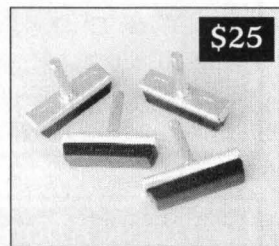

the look is clunky, but there's a lot of fantastic rubber there, and they'll outlast most other shoes. If you live in the flatlands, you don't need these.

Mathauser Road shoes: 15-093

Four Mathauser Canti Shoes: 15-095

Dia-Compe SS-5

(for canti, centerpull, sidepull)

Dia-Compe SS-5, by model, and they're the best mountain levers we've seen, used, tried, or heard of. Made in Japan years ago, but new-in-the-box, and this is the last of them. Superlight, beautiful in all the details, cold-forged for strength, designed for cantilever or sidepull brakes (not V-brakes). These are as good as this type of lever gets, and once our supply is gone, see you later. Will you ever have a need for this type of lever? Then get these now or something worse for more loot later. This is our preferred lever for the Albatross and Dove bar. Blue anodized only. No cables or anything like that, but they come packed well in a nice box.



Blue SS-5: 15-112

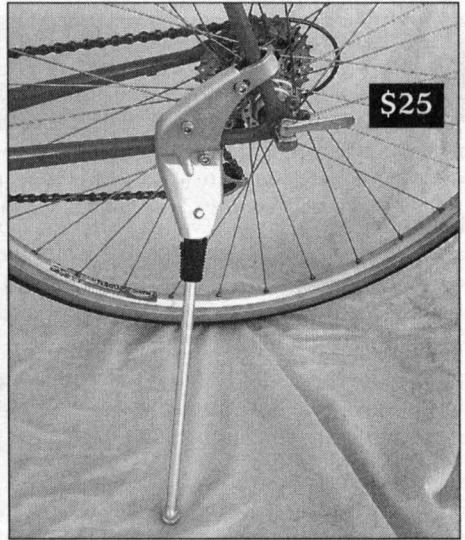
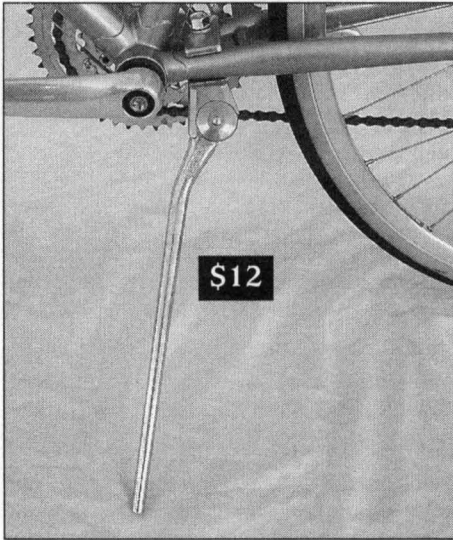

Two Fine Kickstands

The Greenfield on the left has been made in America for 25+ years with no perceptible changes, because it works. If you've spent any time at all around bikes, you've seen a Greenfield kickstand or five hundred. This model is the center-mount (normal) one, and it mounts onto the chainstays behind the bottom bracket. **Tip:** Tape the tubes first, and don't play Charles Atlas when you clamp it on. Die-cast aluminum, 9.9oz.

The Minoura, a rear-mount kickstand, clamps onto the rear stays of most bikes. Tape the tubes first. This style is more stable but also less stealth-like (sneakers be warned!). It works great, and is our first choice for light-tubed frames, but don't let that scare you off of the Greenfield. They're both good.

Greenfield center-mount: 20-104

Minoura rear mount: 20-107

All we are saying...is Give Kickstands a Chance

Most bike snobs go their whole adult life kickstandless, and yet some people can't imagine riding a bike without one. A kickstand doesn't weigh that much—the ones here are about 10oz each, which is on the light side, but again, those who use them now would still use them if they weighed two-and-a-half times that.

It's easier to load and unload a bike when it's upright. So, for touring and commuting, a bike really ought to have one. When you want to park your bike downtown by the sandwich shop, a kickstand may not be a lifesaver, but it sure makes it easier. On organized rides, centuries or whatever, a kickstand means you don't have to lay your bike down as you attack the snack table, or fight for rack space with the other kickstandless riders.

The concept is just too sensible, and yet for decades now, most bike riders have shunned them. If you just can't warm up to the idea of a kickstand, that's fine. There are tricks to keeping a bike upright while leaning against a tree or building, and we all learn them eventually. But a kickstand works better all the time, and it weighs well under a pound.

Introducing SPEEDBLEND tires

SpeedBlend™ tires are my invention, but they're not what you'd call a brainy one. They're so obvious that somebody should have done them fifty years ago.

Here's the idea: You put two or more colors on the tire (in the tread or on the sidewall, as available technology allows) so that when the wheel rolls, the colors blend to form another color. The speed at which they blend depends on the length of the color segments; the smaller they are, the more readily they blend at slow speeds. You can design tires that blend at 3mph or 50 mph or anywhere in between.

Despite the name, determining speed by the color blending isn't exactly the point. Although it's possible, cyclometers work better. The SpeedBlend point is fun, not fun in the thrilling sense, but in the interesting and novel sense. It is fun to see the colors blend.

It is theoretically possible to make the blended color anything, by using different static colors. I've experimented with electrical tape and colored Sharpies and discovered that equal-sized segments of navy, yellow, and red blend to form tan, the same color as a skinwall tire. In that case, the tire looks wild at rest and normal at speed. Another benefit of the colored sidewalls is UV protection. Lightweight tires often suffer from long exposure to the sun, and the color here is like a sunscreen.

What I really want is for some car tire maker to think this is a good idea, and then either buy the patent from me, or license it. Either way, I get happy. But it seems that car tire makes prefer their tires to look the same as everybody else's. Still, if enough of these get out there, maybe that will change. Until then, ride them as though they're normal tires, and wave and smile at the people who wave and smile at you and say something like, "I like your rims!" even though it's the tires.

How Fatta Tire Ought You Ride?

Here are some General Guidelines. We are not suggesting you disregard the tire maker's recommendations. These are general rules, that's all. But they are good general rules!

In the minimum tire width, we've been super conservative. For instance, even though we list some tires as skinny as 21mm as a minimum, we actually can't imagine any reason for riding a tire less than 27mm for anything that isn't a race. No matter what you weigh. There's just no advantage, and a little more air and a little softer ride gives you more comfort and traction, and protects your wheels better. The listed width, by the way, is actual width, which is usually less than the stated width.

Rider Weight	Surface	Minimum Tire Width	Minimum PSI
Under 150lb.	Smooth	21mm	85
	Rough	25mm	80
	Dirt/trail	27mm	80
150 to 180lb	Smooth	23mm	95
	Rough	27mm	85
	Dirt/Trails	32mm	75
180 to 210	Smooth	25mm	95
	Rough	27mm	90
	Dirt/Trails	35mm	75
215 to 250	Smooth	27mm	100
	Rough	32mm	90
	Dirt/Trails	37mm	75



Is the *Ruffy Tuffy* the Smartest Road Tire In the World?

We say yes, hands down. It's our design, made just for us by Panaracer in Japan. The Panaracer factory is relatively small by tire factory standards, and the quality and quality control are unsurpassed. Naturally they have all the automation and computers you'd expect from a modern Japanese manufacturer, but in addition, every tire that leaves the building is thoroughly inspected by hand. You don't see Panaracer tires as original equipment on many bikes, because product managers try to pay less than \$6 per tire, and nothing out of Japan comes anywhere close to that.

But the Ruffy Tuffy is the roundest, best-cornering, most consistent, strongest, and safest lightweight road tires we've ridden, and are as perfect as any product in this catalogue.

1. It's 27MM WIDE, THE FATTEST tires that fit 98 percent of the road bikes today. They're rated to 120psi, but what's the point? At 90 to 105psi, they're cushy and fast. If you're racing, go ahead and ride skinnier tires. If you don't race but like to pretend that you do, ride skinnier. If your bike's fork is so short that it can take only a tire up to 700x25 and you don't race exclusively, your fork's too short and you have to ride hard skinny tires.

2. It's EXTRA ROUND, due in part to a special three-part mold. Round tires corner better. They don't "dive" when you lean them over hard. These are the best cornering tires we've ridden, and it's safe to say that if you slide out when riding these, it ain't the tire's fault.

3. THE TAN SIDEWALL makes it easy to look down and detect a leaking tire.

4. BLACK, CHECKERBOARD TREAD WITH NO-SLIP/GRIP. Black, because it's a good color for tires. Checkerboard, because we aren't sure whether slicks or treaded tires work best, so it has both. No-Slip/Grip is Panaracer's latest rubber compound, which wears as long as hard rubber, and grips as well as soft rubber. Somehow, they managed to figure out how.

The Ruffy-Tuffy has every quality we like in a road clincher. You won't find a better made tire at any price. It's expensive, but it's safe. We're big believers in not riding cheap tires.

Approx. weight: 350g. With wire bead only.

SpeedBlend only for a while. It's my way of getting them out there.

Ruffy-Tuffy SPEEDBLEND(700x27): 10-054\$38

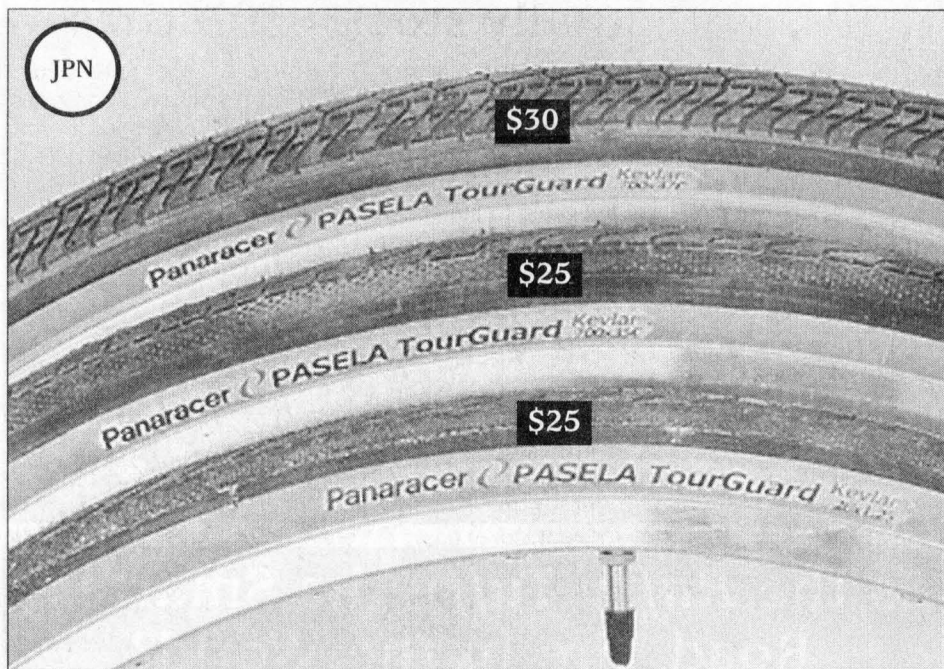

Panaracer Pasela

This the the best non-650B tire we've ridden for touring, mixed road and trail, and commuting. Although we like a rounder tire for extreme, high speed road cornering, when the riding is more straightaway, as it tends to be on tours and just getting from here to there, then a bit more tread on the center of the tire is a good thing. It still corners fine, and is a fantastic do-everything road, tour, and light trail tire. The 700c has a wire bead, and weighs 390g. The 26-incher has a wire bead and weighs 320g. If you're after a super versatile, tough, great riding, long wearing, never-have-to-think-about-it road tire, this is the tire for you. Made in Japan, it always mounts tight and rolls straight. The 700x37 is the best highish-volume all-around 700c tire we've ridden.

700x35 Wire: 10-028
\$25

700x37 Wire: 10-050
\$30

26x1.25 Wire: 10-032
\$25

Inner Tubes

The standard road claims to fit to 700x32, but it'll go to 700x38, easily. The superlight 700c says it fits to 700x25, but we use it up to 700x28. The 26x1 says it goes up to about 26x1.25, but 26x1.4 is fine; the 26 medium fits to 1.75; the fatty, to 2.3. They stretch!



Weights & Part Numbers

700 Superlight67g#10-004\$6
700 Normal120g#10-001\$4
700 Super Fat160g#10-008\$7
26 Skinny119g#10-005\$6
26 Medium133g#10-002\$7
26 Fat200g#10-007\$7
650B (all)125g#10-XXX\$7

Yes, we actually stock 650B tires

With a bead seat diameter of 584mm, it's bigger than a mountain bike tire (559mm), and smaller than a 700c road tire (622mm). It was popular on the fanciest and finest French touring bikes in the '40s through '90s, and on cheap old three-speeds from England and America. Bikes shops don't generally stock it and most bike people haven't even hear of it, but we like the tires, have actually designed a couple of bikes around them, and so naturally we're obligated to support those bikes. Our selection is representative of what's out there, but there are half a dozen models that we don't stock, and we're hoping to have another model next year, something around a 650B x 34mm.

Panaracer C de la V

A lightish, puffy, skinwall tire that measures 38mm wide and weighs 430g. It grips well, rolls smooth and fast, and with a psi rating of 50, it's like riding on fast marshmallows. A wonderful tire in every way. We're lucky they make it.

Panaracer 650B: 10-063



Mitsuboshi Trimline

This model is virtually identical to the Col de la Vie, we're stocking them both just to drive home the point that yes, we're serious about this tire size. At 38mm wide (and 420g), one wonders why it's the "trimline."

Mitsuboshi 650B: 10-061

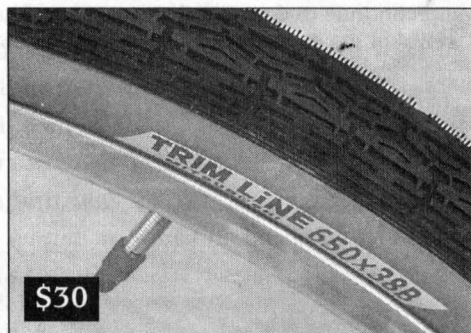

Michelin Megamium

The fast and skinny French cousin to the Japanese tires above. It measures 30mm across and has a pressure rating of 75psi. When the road is smooth and speed is your utmost concern, go with this tire. It weighs 360g. Blackwall,

Michelin 650B: 10-064



Schwalbe HS 159

Schwalbe is a German maker who makes many of its tires in its own plants in Indonesia, and whose big thing seems to be puncture protection. Don't be put off by the weight—this is a great, tough tire for commuting and rotten weather. 896g.

Schwalbe 650B: 10-059





The main thing about fenders is that if you willingly and joyfully ride in the rain and on wet roads without them, you are, in the words of Mark Twain, a simon pure labrick. Riding in the rain with them is pleasant, not just for the pleasure of pedaling, but also for the feeling of smugness you get when you see poor saps without them. The amazing thing is, 98 percent of all modern road bikes don't have fender clearance. (Ours do.) One can only wonder what the designer had in mind when that decision was made, but in any case, when it comes to fenders, these are our favorites. They're excellent, easy, and made in—you guessed it—Germany!

Front fenders are always too short. These don't come with mudflaps, but you need them. Make them from duct tape, a water bottle, or an old leather shoe tongue (zip tie on). Do it to the rear one, too.

SKS Fenders

These are the fenders we ride six months of the year. They're made from recycled German plastic and have top-notch stainless steel hardware. We've tried many others, and continue to do so, and always come back to these, as you will, so you might as well skip the experiments. Four sizes fit 26-inch and 700c Wheels, Fat and Skinny

For 26-inch tires up to 1.5: 27-002

For 26-inch tires up to 2.0: 27-003

For 700c tires up to 700x32: 27-004

For 700c tires up to 700x40: 27-005

Fender stays and all hardware, but no dang fenders: 27-007 \$15

Spoke Reflector (one)

Regular plastic spoke reflectors are fine, but everybody takes them off bikes because they're rigid plastic, heavier than necessary, and make it harder to true a wheel. Not so with these! I/Grant have used these for more than 20 years. It weighs 11g and goes on and off in two seconds.

Spoke Reflector: 31-371

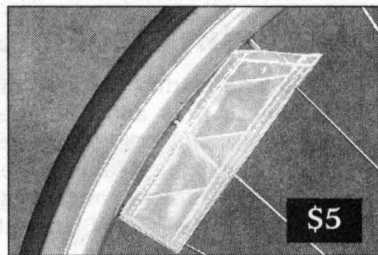

Ankle Band (one)

This is the best ankle band out there. It's our own design, and one I/Grant have used for 14 years. It closes up the pants, and places a big reflective strip out towards traffic, where motorists can see you. Easy on and off. Sewn for us in Colorado by the same woman who used to sew them for us in California. Connie. White or yellow Reflectite. Whatever we have, and they both work.

Ankle Reflector: 31-370

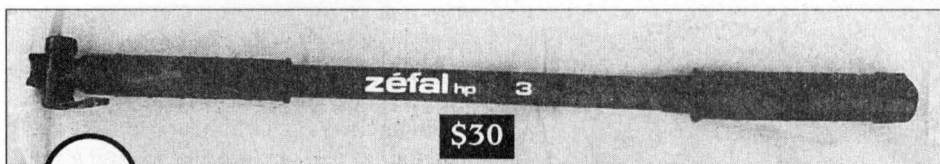

FRA

Zefal HPX

The Zefal HPX is far and away, hands-down, why-does-anybody-else-even-try?, the best frame pump made. Nobody tries it and goes back to anything else, and if you ride enough, it is the pump you will eventually end up with. It is not light and attractive, like the Silca. But all that aside, when you want the pump that makes all others quake in fear and hide in shame and turn brilliant green with pump envy, get an HPX. If you aren't an HPX user already, that's fine, but if you ride enough and live long enough, your epiphany will come.

Fits presta or schrader valves. Easy to use, simple instructions—please read 'em.

Zefal Sizing:

Measure the distance between the tubes, not the tube length itself.

Zefal No. 3 fits gaps 46cm to 52cm: #28-013

Zefal No. 4 fits gaps 50cm to 56cm: #28-014

Rebuild Kit: #28-018 \$10

Contains cap, rubber gasket, rubber plunger, wings, lever. That'll do it.

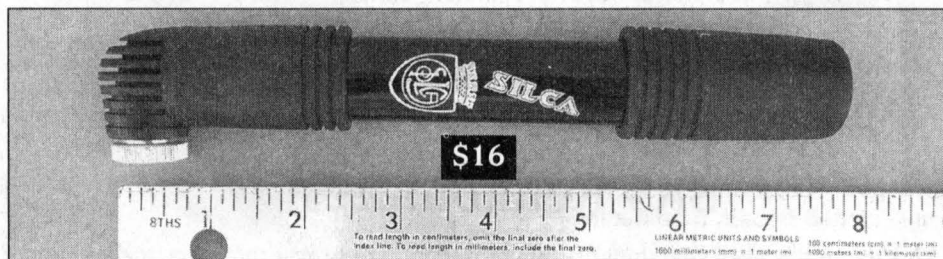

Silca Mini Telescoping Pump

The best mini we've tried, and before we put one in this catalogue, we tried many. Some are even smaller and lighter, some look more substantial, more clever, or more powerful, but there's always something about them that kills the deal—hard to grab, or the plunger handle hits your other hand, or the stroke is just ridiculously short. This Silca wins because it telescopes, so you get a much longer stroke than with many; and it's easy to hold onto the valve; and when you pump with your right hand, you don't pinch your left hand. It still takes forever to inflate a tire. But Mark here uses it, and I/Grant have used his, and if you need a small pump to fit into a jersey pocket or tool wrap or Banana Bag—or you carry your bike up long flights of stairs to get to the train platform, and a frame-mounted pump gets knocked off—then a mini is the way to go. Compared to a Zefal HPX frame pump, this Silca Mini is absolutely terrible, frustrating, throw it away! But if you need a mini, you can buy this one confident that it works better than the others. Four ounces. Presta only.

Silca Mini: 28-023

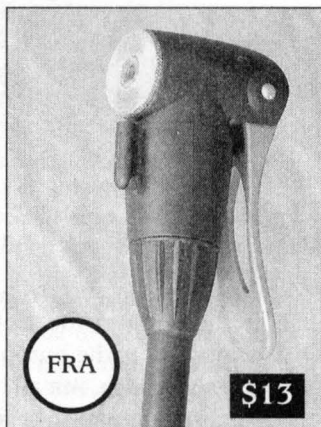

Got An Earlier Version Of This Pump? Then consider getting this head for it. It's one of those rare cleverish high-tech-looking plasticky things that actually works great. Fits presta or schrader heads, no swapping or fiddling. Stays on snug, you won't need a friend to hold it while you pump. It's worth getting even if your other head works okay.

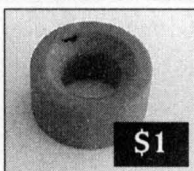

If you use your pump a normal amount, don't bother with this, because you won't need it for a long time. But if you're a heavy user or a worrier, spend the \$1 for this. Putting it in is, as they say in England, "a bit of a bear," but sometimes life's tough. No returns, no matter what.

SKS Renkompressor

This pump has been sold under several different brands over the years, including VAR, Zefal and some others that don't immediately come to mind. It's the pump we use in the shop, and it's the pump that made me retire my perfectly functioning Silca track pump, after 22 years of service. This one seems as well made, and I like the huge wooden handle, and the bigger foot steps on this one. Plus, it pumps up faster. It's not the fastest pump in the world, but it's plenty fast, and the fancier ones have more plastic in them, and I don't entirely trust the complication.

This new version has a neat head that works equally well for presta or schrader valves; and it never, NEVER slips off unless the gasket is worn out, and we have spares. If you don't have a good floor pump, you're wasting your life. This is a good one, and it's probably good for 20 to 30 years. All the small parts are replaceable and the whole pump is rebuildable. It comes with the head shown, which works on both Schrader and Presta valves, but if you're offended by a Universal head and don't have any Schrader bikes around, you can get the Presta-only head for it. Attach it using the clamp (included), or with zip-ties or baling wire.

SKS Pump: 28-015

Separate head: 28-020

Xtra Gasket: 28-022

Ex-Var Lever

Formerly marketed under the VAR name. It is plastic and sometimes breaks if your tire is extra recalcitrant, and it's cold out. But most of the time, it's the best thing since pumpkin pie for mounting tight-fitting skinny clinchers. It shan't pinch the tube! Just not when it's cold out.

Ex-Var Lever: 19-045

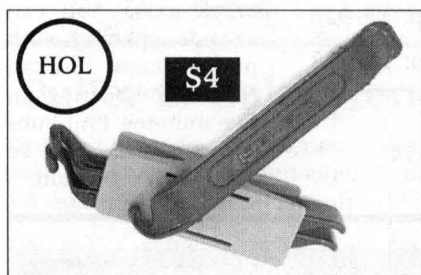
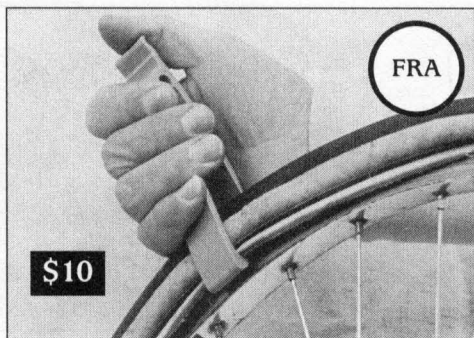

Dutch Tyre Levers

These are imported by Kool Stop, but they're made in Holland, the same country that brought you Van Gogh, Vermeer, Windmills, Wooden Shoes, and Joop Zoetemelk. They're as reliable as any plastic lever, pretty good, and they have a built-in tube abrador in the case. Three per set. These are good.

Dutch Levers by Kool Stop 19-075



Universe's Best Patch Kit

Small patches are better, and these, made in France by Velox, are the best we've used. You get 10 of them. And now we include a tube of European glue with them; a single glueless patch, and a small square of sandpaper or emery paper—whichever the local Five & Dime has on sale that day—and a ten-cent piece, to verify that the patches are indeed dime-sized. The glueless patch isn't in this photo but *is* included.

Uni's Best P. Kit 10-048

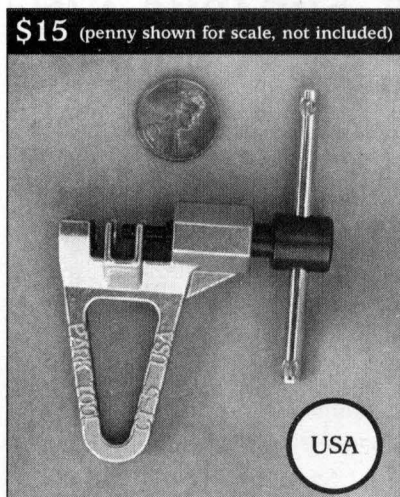

Minnesota's Best Chain Tool

Good luck if you break a chain and don't have a chain tool. There are lots of tools you can make from sticks or rocks or roadside debris, but a chain tool isn't one of them, so carry one. Not just for you. Can you imagine the satisfaction of helping somebody with a broken chain? It's right up there with...well, it's hard to say what it's right up there with, but it must be something pretty good.

Some multi-tools have chain tools, but a dedicated chain tool is easier to use and works better, and that's why we like this one. Made by Park (in Minnesota).

Park Mini Chain Tool 19-076

• No. 15 Winter '04 - '05 •

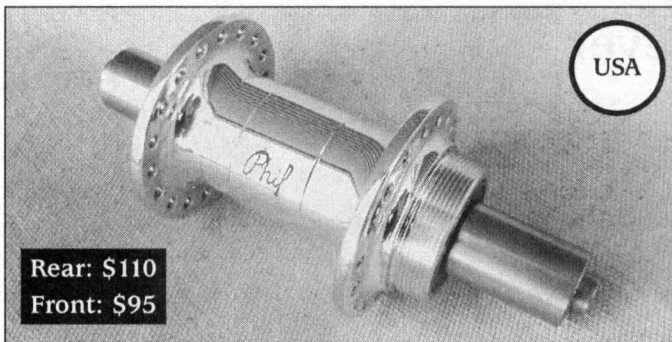

USA

Phil Hubs

If you still ride free-wheels, hang in there with arguably the best threaded rear hub ever made. The body is machined aluminum, and the axles are made of super strong 17-4 stainless steel.

Rear: \$110
Front: \$95

Rear:

130x32°x7sp: 18-035 135x32°x7sp: 18-036
130x36°x7sp: 18-037 135x36°x7sp: 18-038

Front:

32°: 18-033 36°: 18-034

You won't bend or break axles. You can change spacing with new endcaps. You can replace the bearings in five minutes. Phil hubs last a lifetime, and so are always a bargain.

Phil Cassette 8/9 Speed

If you're rich or just want the best cassette hub, and are willing to scrimp in other areas, then here you go, pal. How is it better than all others? Well, it has a larger diameter axle, which has to be stronger. It has more pawls, which is absolutely stronger, and it is made to closer tolerances and has a better finish, which costs more. It's made in America by Phil, and everything Phil makes is the best of what it is.

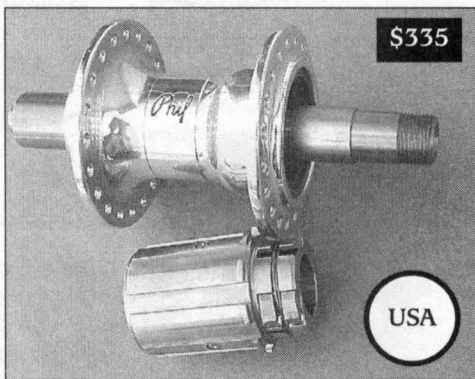

\$335

USA

130x36: 18-142

135x36: 18-143

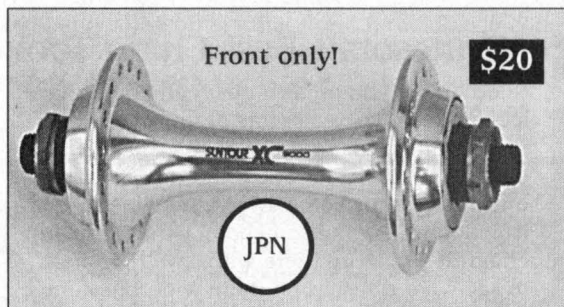

Front only!

\$20

JPN

SunTour 32H XC9000

This hub and the SunTour Lite front derailleur support the theory that a low price scares off people looking for high quality. It is as good a front hub as has ever been made. Cold-forged body, angled flanges, sealed and shielded bearings, made by SunTour at its peak. All that for only \$20. No quick-release comes with them, so borrow one from another wheel.

SunTour XC9000: 18-052

\$ 20

Save Your Neck!
Don't ride any wheel, especially a front one, unless the quick release is properly closed. If you don't know how, find out. We can send you instructions, free of charge. Request by fax (925) 933-7305 and include your address. Or request it on your order.

Two Y-Wrenches

The Hozan has 8-9-10mm sockets, and is always the first choice for cantilever brakes and fenders, although you'll find other uses for it, too. The Park is the killer tool for 99.999 percent of the allen fittings on your bike, and we prefer it to simple L-shaped allens. Every bike assembly we do uses one of these. Get it!

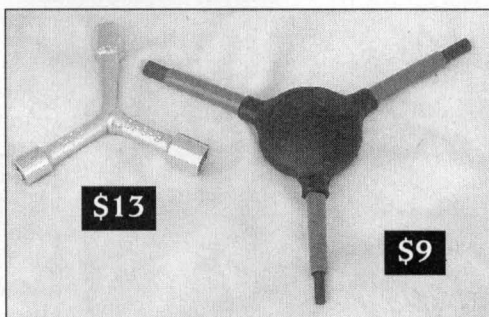

\$13

\$9

Hozan 8-9-10 socket Y-Wrench: \$13 19-023

Park 4-5-6 allen Y-Wrench: \$9 19-068

Puller & Bolt Wrench

The bolt wrench fits 14mm crank bolts (some these days are 8mm allen...), and has a deep socket that won't slip off.

The puller extracts virtually all cranks. If you have a freaky one, you probably know it by now; otherwise, this is the tool. Made in the USA by Park. We use these very tools.

Crank Puller \$18 : 19-060

14mm Bolt wrench \$12: 19-061



\$18

\$12

USA

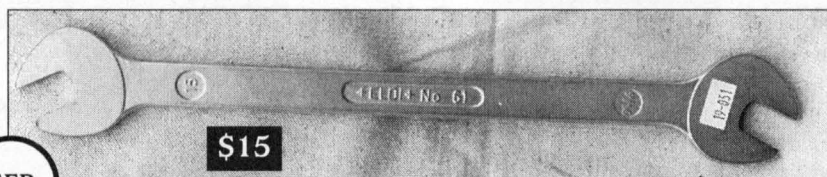

\$15

GER

Eldi No. 61 Pedal Wrench

The best we've ever used, and a true classic. It's long, so you get tons of leverage. So much, in fact, that we recommend holding it amidships for installations, and at the end for removals. Hard, chrome-vanadium steel. German. Tough. There's a 15mm and a 9/16-inch end, and good pedals take the 15.

Eldi No. 61: 19-051

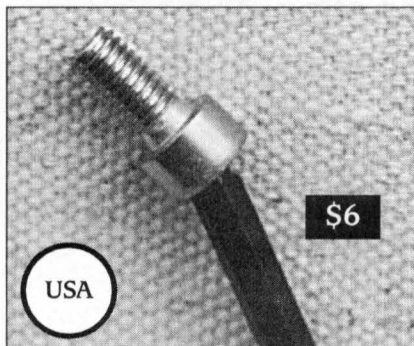

\$6

USA

4mm Bondhus

This is a sanity saver. As you can see, it lets you attack the bolt from an angle, which is sometimes the only way to do it. Some bottle bolts have 3mm heads. There's no good reason. Replace them with 4mm bolts and use this. It is worth the \$6 on the installation of two water bottle cages alone. (Assuming your water bottle bolts are the practical 4mm size.)

4mm Bondhus: 19-011



\$5

The Original Dumbbell

Before allen fittings, this 6mm through 15mm spanner fit most of the bolts on a bike. No more, but we decided to stock it because it's made in England by the original maker; and it's cheap. You'll find the 14mm or 15mm good for fixed-gear axle bolts. The 8mm is good for brake pinch bolts that aren't allen. It's a nice shape and size. If you've got an older bike or a bike with a rear track/fixed gear hub, it'll be as useful as it is cute.

Original Dumbbell: 19-063



USA

\$6

Quick-Glo

You got bare steel around, you're gonna get rust...eventually. You make popcorn on the stove, you're gonna burn the pan...eventually. Quick-Glo has been around for 41+ years, and is as useful in the kitchen as it is in the garage. Rub it on with a Scotchbrite pad, and just watch that metal gleam! Being non-toxic (no rubber gloves needed). It's cheap and works well. Have it around.

Quick-Glo: 31-015

Phil Tenacious Oil

Some places are just too hard to reach with grease (like the threads on brake pinch bolts), and regular oil is too drippy. This is perfect. It is tenacious, and as thick as cold syrup, almost a substitute for grease sometimes. We go though a bottle a year; yours will likely last you five years. Keep some around!

Phil Oil: 31-013

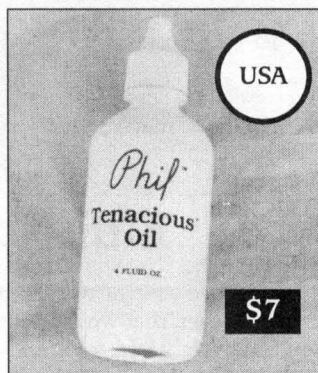

USA

\$7



\$14

Boeshield T9 Metal Protector & Lube

If you have metal around and you want to protect it from the elements and rust, this is it. Spray the insides of the tubes on steel frames to stop rust. Use it where you might otherwise use WD-40 to stop squeaks in door hinges. It's also a super chain lube—our No. 1 until this ProLube stuff (listed elsewhere) came along. Developed by Boeing to protect airplanes. It dries waxy, and works great. One can, 12oz, rustproofs seven frames and lubes a dozen chains.

Boeshield T9: 13-034

Sheep Grease!!!

Listen. Forget that you've never heard it recommended for bike use. It works great for all metal-to-metal contacts and threads. Prep for pressing in headsets. Steerer threads. Smells great. The tube makes it easy to use. It's the oil in wool, and it's useful on your bike and your body. The 2oz tube will last a year, easy, and probably four times that long.



Lanolin: 31-343

Pine Tar Soap

This is our most popular item, and almost all who use it have sworn off other soaps except as a last resort. Oddly enough, women tend to hate it. It has a strong piney scent that reminds you (and them) of the woods and maybe that gives them the creeps. But it cuts through armpit stench like no other soap, rinses clean, is a fantastic shampoo (no more plastic bottles, herbal essence, and faux French names). Try it once and you'll be back. We sell the biggest size, a full 4.25oz, which is larger than the size you usually see.

Pine Tar Soap: 25-001

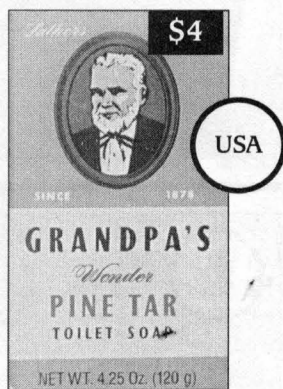

Phil Hand Cleaner

We like the idea of citrus-based cleaners, but this one, made from wood pulp, works faster and better, and rinses off a lot more easily, too. Faster: About three times as fast. Better: It's slightly abrasive, and gets out the grit in the creases and under your nails. It has no smell. It's a Perfect Product.

Phil Gritty Brown: 31-038



Beeswax

It's good on all threaded things you don't want coming loose: Pedal dust caps, crank bolts and dust caps, headset locknuts, chainring bolts. Keeps shoelaces from untying themselves, too. Put it on nails and screws, to make them penetrate wood more easily.

Beeswax: 31-002



Water Bottle

The big size, clear plastic, made by Specialized, and as far as we're concerned it's the best bottle out there. Our logo is printed on it twice. Typically, the top is blue, to match the ink. Now and then we get in the big-mouth version, so please be flexible on that one.

Look around and you'll see that our price is rock-bottom low. It's a promotional item, so we barely mark it up. Limit twenty per customer/forty per household.

Water Bottle: 29-010

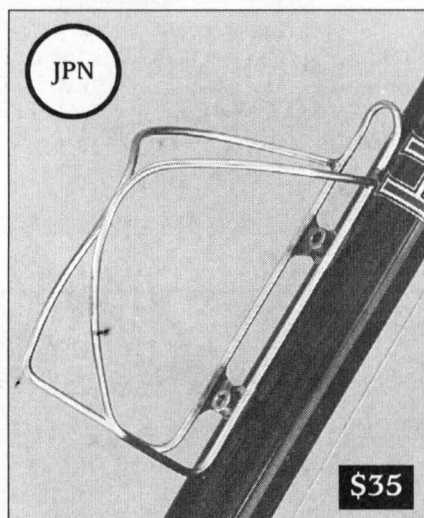

Nitto Stainless Bottle Cage

When we first ordered these, we expected to sell 30 per year. But it's been one of our most popular items, and we may go through 400 of them this year. That figure will make Performance laugh, but it's a lot for us. This is Mr. Yoshikawa's own design, and it is unique and simple, smart and beautiful, strong and functional. Whether you want to spend \$35 for a bottle cage is another story, but it is hand-brazed stainless steel, and it's the cheapest hand-brazed stainless steel widget in the world.

Nitto Cage: 20-030

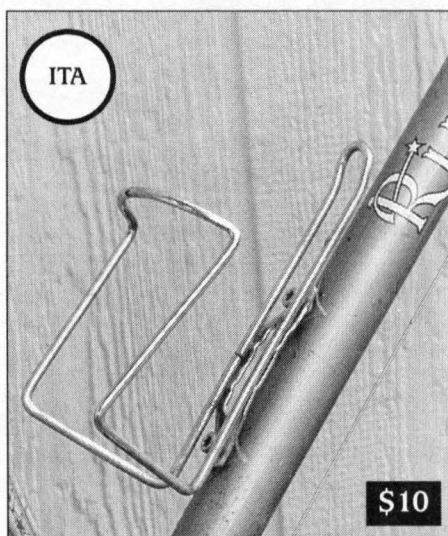

ALE Steel Cage

This is the best value in a bottle cage. Since it's steel, it plain won't blacken your bottle. Compared to Nitto, it's a little crude, and yours may have chroming over tiny, really micro burs, but this remains a 12-star, super champion value, and heavens to merkatroid, at only ten bucks a cage, there's no reason to ride aluminum or carbon fiber cages. This one weighs about 95g, which is plenty light enough. It looks good on any bike, and it holds your bottle securely over the worst roads. The slight amount of rust it'll acquire over the years just makes it look better. Really!

Ale Steel Cage: 29-001

• No. 15 Winter '04 - '05 •

Cyco-Active Map Case

Tough clear plastic that attaches and closes with velcro. It fits an 8.5x11 folded in half, mounts onto the handlebar and rests on the stem. Easy to use, convenient, the best we've used, by far.

Map Case: 20-058

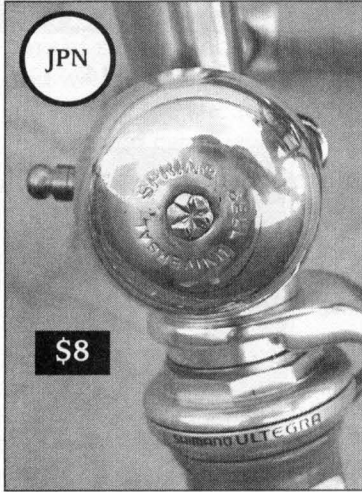
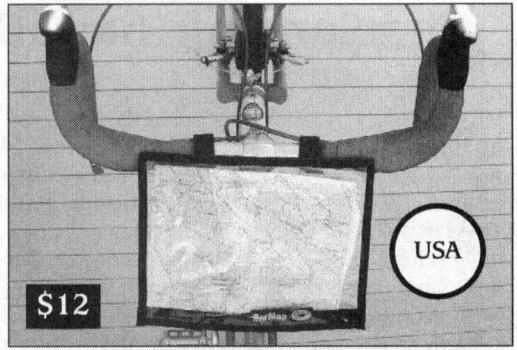

Japanese Brass Bell

Solid brass, made to last a lifetime and then pass on to a Lucky Heir. Brass has the best ring of any material. It's rich and mellow, not the irritating high-pitched tinny ring we've all grown accustomed to over the millennia.

The bell has a coil-spring striker, and it's easy. You just flick it out and it springs back and hits the bell part—you'll be an expert on your third try! Sometimes, on rough roads, it rings itself. If that bothers you, you can space the striker out more. We've found that it keeps the bears away.

This bell rings for 5.5 seconds!

Coil Spring Brass bell: 31-367

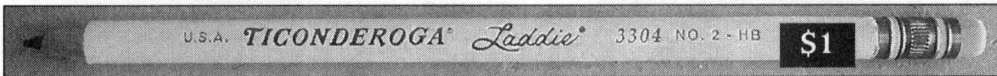

Ticonderoga Laddie—Two for a dollar!

Made for third-graders. It's fatter than most pencils, easier for uncoordinated hands but fine for coordinated hands, too. The lead is thicker, almost never needs sharpening, and NEVER breaks. Writes well on paper, cardboard, almost anything. Hard to find, but we got 'em. Good price. Doesn't fit most pencil sharpeners, but you can sharpen them with a knife, a two-hole sharpener (stationery stores) or the famous Boston Ranger 55.

Two Laddies: 31-372

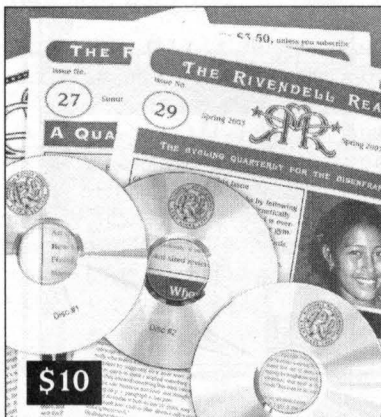

Rivendell Readers on CD

Thanks to recent, epoch-making technological advances, we are now able to offer back issues of the Rivendell Reader in PDF format on CD-ROM. Absolutely no returns (Geez...we aren't THAT gullible) If your CD is damaged such that it is unreadable we can send you another one. Works with Mac or PC. The issue breakdown is as follows:

- RR 01-11: 24-127
- RR 12-21: 24-128
- RR 22-25: 24-129

The Song of Hiawatha

It's a book-length poem that reads like a novel and tells the story of Hiawatha, an Indian. Written in 1851 by Henry Wadsworth Longfellow, who was berated for writing a sympathetic story about Indians. It's written in an 8-syllable per line beat that pulls you through. The language is lovely, almost magical, and if that's not enough, it is illustrated by Frederick Remington. Published by David Godine, with first-class details from type to bindery. It's not a bookshelf book. If you start it, it will pull you through. If you buy this and read a chapter and don't finish it, you may return it for double your money back in credit.



hardback: 23-034 \$23

paperback: 23-035 \$14

The Book of Nonsense

Edward Lear's great work, first published in 1848. Limericks, short stories, a botany lesson, and a dictionary all written in Lear's uniquely weird way. It appeals to children and adults, it is a true classic, and ever since we've offered it, we've had a double-your-money-back guarantee on this. Out of more than 500 sold, only three people have taken us up on it. A beautifully bound-in-cloth edition that belongs in every home with children!

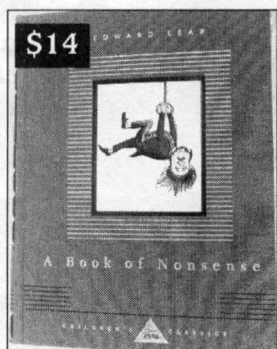

Book of Nonsense: 23-004

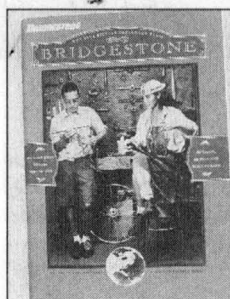

\$8

Bstone 94 Catalogue

The 94 was the last Bstone catalogue, and the last of the three-catalogue series. There are stories about the last all-American baseball mitt, how steel, titanium, and aluminum are mined and processed, and a lot more. We used to sell these for \$1, and hardly anybody bought them, so now we've raised the price to \$8 so we can at least understand the reluctance and feel less insulted. Even at \$8, this is a bargain. And next year it's going up to \$10.

1994 Bridgestone Catalogue: 23-010

The Bicycle Wheel

Wheel building theory and practice, along with a bicycle wheel appreciation course, this book is widely and rightly regarded as the definitive text on the bicycle wheel. Written by Jobst Brandt, it is clear, well illustrated, easy to follow, opinionated, and informative. A great book for non-wheel builders as well, since it contains tons of good and useful information.

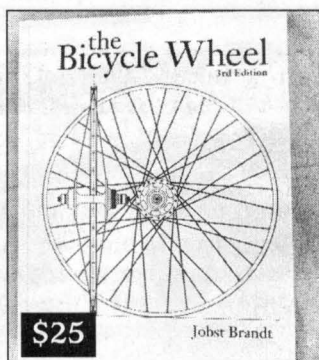

The Bicycle Wheel: 23-008

The Epidemic

This book's subtitle—*The rot of American culture, absentee and permissive parenting, and the resulting plague of joyless, selfish children*—is a downer that suggests the book was written by some ex-Marine sergeant/tough love champion who still wears fatigues and believes sparing the rod spoils the child. It's not like that, though. Author Robert Shaw is a family therapist in Berkeley, and has a breadth of experience to qualify him to a book about how to raise happy children that are responsible, productive members of society and don't rebel and get violent and weird just because they're teenagers. And, if it's slightly too late for that, how to reel them back in and get a new start.

It costs \$15, but if you get it and read it and think it's a gyp, you may return it within 60 days for \$50 credit. This is an important book. It's more likely that you'll buy other copies to pass on to others.

The Epidemic: 23-037

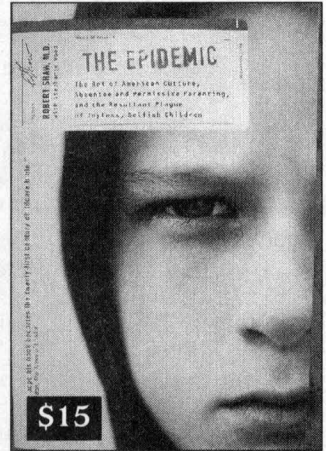

Happy Baby & Toddler Videos

These videos teach you things you might not learn anywhere else. The cover price, for each of them, is \$23, but we sell them for cost just to get them out there.

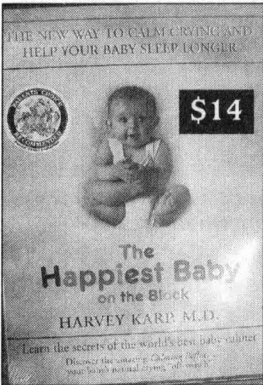

We've offered these before, and the reaction has been astounding. The Baby one tells you why babies cry and how to comfort them instantly. The Toddler one tells what frustrates toddlers, and how to communicate with them before they reach the age of reason. Good videos, by pediatrician Harvey Karp.

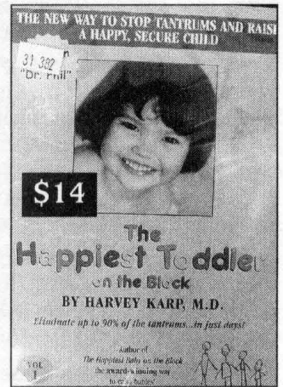

Happiest Baby DVD: 31-380

Happiest Toddler DVD: 31-382

'Sup widda parenting stuff?

Children are even more important than bikes, and every now and then there's some really good information that deserves passing along. The bookstores have so many books that it's hard to know where to start. No doubt there are other good books (or videos) out there, but *The Epidemic* and these Happiest Baby/Toddler videos belong in a special category, and if you're a parent, you'll be glad you got them. —Grant

Friendly Advice To Other Bike Makers

How To Design Better Bicycles

Offered up as free advice, with no snottiness of attitude.

The changes required to dramatically design better bikes are easy and cost nothing. You could sneak them in and not make a big deal about them, as though you've been doing it this way all along, or you could brag about new & improved. It's up to you, but here's what to do, and why to do it.

1. Raise the brake bridge. That's the thing that connects the seat stays, up by the brake. If you insist on using industry-standard short reach brakes, locate it 359mm +/- 1mm above the center of the rear dropout. This will allow a fender with a tire with a radius of up to 340mm. If you're designing bikes without knowing the tire radius, holy smokes, stop it.

If you want to design *super smart* bikes, put the brake bridge 365mm above the dropout. You'll have to use long-reach brakes, but they're readily available in two grades from Shimano, and you ought to be doing that anyway, on anything that's not strictly a race bike. Give up wannabe-race bikes. They send the wrong message.

2. Make the front brake reach match the rear. Since you don't make forks anymore, you'll have to ask the carbon fiber fork factories in China, Taiwan, or the U.S. to make the forks longer. If you insist on using short reach brakes, tell them you want the brake reach to be 48mm. If you use long-reach brakes, tell them to make the reach 55mm. If they say "huh?, what do you mean?" you should not be buying forks from that fork store.

3. Lower the brake hole in the crown. There's no sense filling up space with carbon fiber, when there should be air there to accommodate a fatter tire or a fender.

4. Longer chainstays. There's no benefit to chainstays any shorter than 42.5mm. Merckx raced on that length, so they're stiff enough for your customers too. Longer chainstays improve the ride and the angle of the chain, which is important on bikes spread for 9+ cogs on a 130mm rear end. You should know that. If you have real nerve, make those chainstays 44cm. Think that number will scare customers? It's your job to educate them.

5. More tire wobble room. At 340mm in front of the center of the rear dropouts, make the inside-to-inside dimension about 55mm. This will allow a fatter tire, and it will allow a wheel with a broken spoke to roll through without rubbing. It's time to stop making \$1500+ road bikes that are one broken rear spoke away from being unrideable. Don't leave it up to the customer to ask about this. They put their faith in you to watch out for them when you design the bikes. They generally don't know what to demand, or what questions to ask. Just do it for them.

6. Make them fender-compatible. You're afraid eyelets will scare off the 25-to-34 single male weekend fitness jack? Hooboy. Just do it anyway. The eyelets add a gram or five to the frame and fork weight, and they let you ride in the rain and on wet roads without throwing muck up all around. Not worth the weight? Not cool?

7. Don't design steep seat tubes on small road bikes. Yes, everybody does it, but it's still wrong. Body proportions aren't that different from short to tall, and seat tubes of 74° to 75° almost always put the knee too far forward of the pedal, and when that happens, each stroke pulls you forward and puts more weight on your hands. If you're doing it so you can have a braggin'-short top tube and no toe clip overlap with 700c wheels, that's kind of pathetic. Small bikes with short top tubes shouldn't have 700c wheels.

There are other ways to design better road bikes, but this is a good start. I know this sounds arrogant, but it's all true. Go back over the list and see if you can find any holes, anywhere. The only one you're likely to bicker with is No. 7, but that's because there's no space here to make the point more clearly.

If you find any of this useful and you want to keep going in this direction and actually help the cause (of well-designed, comfortable and versatile road bikes), ask Shimano to make a dual-pivot sidepull with a brake reach of 67mm, and fender-friendly arches, like the old inexpensive Dia-Compes and Weinmanns. Then you could shoot for a mid-slot placement and still easily fender a 700x35.



\$15

- XL: 22-397
- XXL: 22-398
- XXXL: 22-399

Summer Gloves

Modern cycling gloves have gotten to be too weird, bright, complicated and flashy. Too many materials, too many colors, too many promises to solve all your hand ills in one compact little package of lies.

Well, that may be a bit over the top, but we like these better, anyway. They're as simple as can be, except for the terry-cloth nose-wiping section behind the thumb. That, we can allow. But no logos, no gratuitous color, no developed-for-the-space program gels. All cotton with padded leather palm. Don't raise your eyebrows at the sizes. We've been buying these same gloves from the same Pakistani maker for years, and

it's finally sunk in that "small" over there means infants, "medium" means 12-year old girls, and "large" is the same size as medium. If you're a normal guy who doesn't exactly know his hand size, get a XXXL. A normal woman and you know for a fact that your hands aren't super dainty, get XL. A slightly loose fit is good, though unlikely.

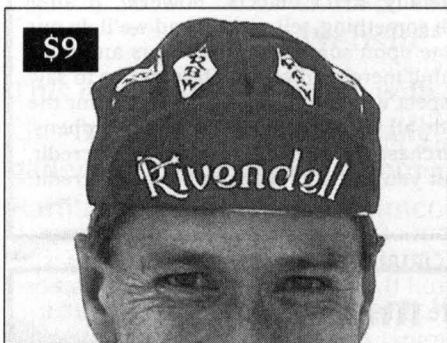

\$9

22-399 \$9

Cycling Cap

100 percent non-organic cotton, made in the USA. These fit fat American heads better than the European caps do, but they're still not right for my/Grant's head, so I always cut out the crown and make visors out of them. Then they fit under a helmet nicely. If you're less of a fathead, just wear it like a hat. The color changes every 144 caps we sell. We take turns picking the new color, and the current color is undetermined, and but it looks fine, really.

Gift Certificates

The perfect gift for any cyclist, wool-wearer, soap-user, book-reader, or user of refrigerator magnets. Always a popular gift, and if you're the spouse, parent, child, or friend of someone who has this catalogue, then it's a sure hit; and look at the savings.

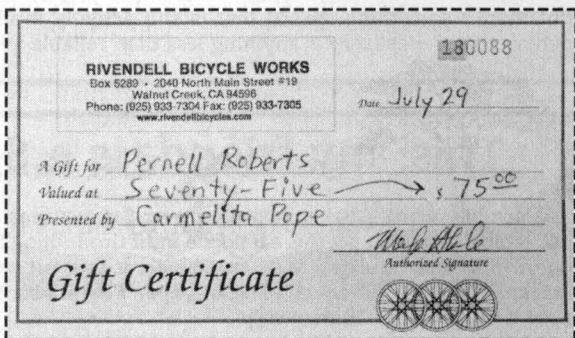

\$25: 24-082

\$24

\$50: 24-083

\$47

\$75: 24-084

\$71

\$100: 24-085

\$92

Our Dearth-o'-Nines Pricing Strategy

Many of us here feel that nothing but nothing wins the "Make it seem like a cheap trinket while simultaneously insulting the customer" award like a price that ends in \$0.99. The higher the price and the more 9s there are in the price, the worse it is.

No doubt studies have shown it to be effective—probably more so than prices that end in \$0.95, which to us are just a gnat's hair more tolerable—but who does it actually fool? Fools, is who! Non-fools just round up, and fools should be protected, not taken advantage of. We say this as fools and former fools, speaking for all fools, if we may.

We're even careful about whole-dollar prices that end in 9, and in ten years of catalogues, I think only one of them has slipped in, and it was a mistake, and changed in the next catalogue. Prices that end in \$0.50—we have no problem with them, and in some cases they'd make a lot of sense, but we're trying to keep our "even dollar" streak alive, so we sometimes round down, sometimes up. The books we sell almost always end in \$0.95, and we don't berate the publisher for it. We round those up a nickel, and that may make us the high-price leader in the book world, but what's five cents?

Our Guarantee

We won't sell it to you unless we know from personal experience that it's good. We don't exaggerate any claims. Every now and then, except in Nitto's case, a flawed something slips through from an otherwise reliable maker. Truly defective merchandise is rare, and defects that show up after extended use generally aren't defects...however, if after extended use, you find yourself dissatisfied with something, tell us why and we'll do our best to make it right. Over the years we've come upon some serious abusers and folks whose social life seems centered around returning merchandise, which forces us to say: We reserve the right to not sell to you, if we suspect we're just playing catch. But for the rest of you, we want you to be happy, and will do all we can to make sure that happens. You may return any item within 30 days of purchase for a refund, exchange, or credit, as you wish. After 60 days the refund's out, but you can still exchange it or get credit. You pay the postage.

What are we missing?

in any item that you feel fits our catalogue but isn't currently listed. It should be currently made and it helps if it's not readily available in Anybody's Local Bike Shop. The best way to submit entries is by postcard. Delivery matters a lot. If your town butcher makes one or two pair of wooden fenders per year on the side—that's not up our alley. But there's something special that is still actually available and you've no reason to believe that the delivery is anything less than reliable, please let us know. Thanks,

This, my friend, is a \$10 Coupon

It is actually worth \$10 on any order over \$10 between now and Feb 1, 2005. It is not our fault if you don't get this catalogue until Groundhog Day, but we'll offer a grace period of four days. So: Feb 5 is it. You must cut this out and mail it in. No phone use, no faxes. It has to be this actual piece of paper. Thank you. Members or non-members, this time it don't matter. Print clearly.

Name

Address

City

State Zip

Telephone:

Email:

Send it in with the order form, also in this catalogue. The order form can be a copy.

Publications

THE RIVENDELL READER. It is our quarterly cycling publication, described in detail on the next page.

RIVENDELL FRAME BOOKLET. Twenty-four pages on our finest lugged steel frames. A Rivendell is as fine a frame as it is possible to make, and it is designed just for you and your riding. In this booklet, we tell you all about them, and even if you can't afford one, you'll learn a lot from this. FREE.

ATLANTIS FRAME BROCHURE. Four pages on this most versatile, rugged, production touring and trail frame/bike. FREE.

RAMBOUILLET BROCHURE. Four pages on this amazing road frame. It takes sidepull brakes, yet accepts tires up to 700x38. It's easy to control at any speed, and on any surface you have any right to be riding a road bike on ... and some you don't. FREE.

To request a FREE brochure:

Tele (925) 933-7304 or Fax Toll-Free (877) 269-5847

Website: rivbike.com

This catalogue and more, with updated inventory. Archived articles from the Rivendell Reader. Lots of useful information. A gallery of color photos of our customers' Rivendell, Atlantis, and Rambouillet bicycles. Technicolor photos!

Online Forum: go to rivbike.com

...and click on the link that tells how to get on it. Talk about our gear, plans, bikes. Ask questions, get answers, and show your bike to others. It's one of those online community sorts of things, like everybody else has. Now we do, too.

Contact Information

Telephone: (925) 933-7304 or Toll-Free (800) 345-3918

Toll-Free Fax: (877) 269-5847 or (UPS) COW-LUGS

Normal Fax: (925) 933-7305

Website: www.rivbike.com

email: Info@rivbike.com

An Overview of the *Rivendell Reader*, and How to Actually Subscribe

This is for those of you who may have gotten this catalogue at an event, and probably haven't heard of Rivendell until now, and who definitely don't know that we also publish the *Rivendell Reader*.

The *Reader* is our own publication, a bike magazine of sorts, but without, unfortunately, the color & glossy pizzaz. What the *Reader* lacks in glossiness it makes up for in content, though. Since it carries no paid advertising, we have no advertising-to-editorial ratios to shoot for, and consequently, the articles and interviews are often more developed than you'll find in a publication with advertising.

Also because we have no paid advertising, there's a certain objectivity that is harder to come by in publications that live on advertising (and they all do). I'm not saying we're totally objective, or that the real magazines are unable to be so; just that we have a built-in advantage from the get-go. We still have an axe to grind, though.

The *Rivendell Reader* doesn't cover racing; others do it better and it's not our focus. Also, there's less focus on high tech and New Ways than there is in mainstream magazines. We aren't cavemen by any stretch, but there are a lot of older styles and approaches and attitudes that are still valid and valuable today, and we don't bury them.

Riding a bicycle is inherently fun, and we don't assume you're in it just for the fitness payoffs. We try to promote cycling as practical and thrilling without falling into the usual traps—how to go faster than your friends, how to ride your first century, and why you should commute instead of driving a car, even though it's pouring outside and you live 15 miles from work.

We review bikes and parts, both new and old, and often compare the new with the old and make some judgment as to which one deserves to live or die. In many cases, there has been progress, and we acknowledge that (in bicycle lights, for example). But in just as many cases, many of the

best designs of the past have been discarded in favor of new nonsense, and we point that out, too.

Our interviews are pretty good ones. Past interviewees include Tom Ritchey, Jobst Brandt, Maynard Hershon, Lon Haldeman, Sheldon Brown, Phyllis Harmon, Mike Barry, Kozo Shimano, Nitto's Akira Yoshikawa, Toyo's Tetsu Ishigaki, and Charlie Cunningham—all people who have carved their place in the world of bicycling, and have an interesting perspective worth sharing.

By the time you read this, we will have published at least 33 issues (four per year for the past several years), and they've averaged more than 40 pages per issue. Since most of that's readable, you get more content than you do in a typical bike magazine of 80 to 90 pages.

Other things we address: A How To section (Fundamentals), teaching you how to do something basic on your bike, something every cyclist ought to learn or at least know how it's done. Everything from fixing a flat tire to pressing in a headset using tools you can buy cheap within five miles of where you live.

We also have articles on historical bikes, bikes of note from the past, that have influenced modern designs. If you like bikes and you like history, you'll get your fill. There's a science column, too, and product reviews, and we have a few columnists that have their own view of the world and what matters to them.

We put a lot into the *Rivendell Reader*, and our resubscription rate is about 90 percent. Many of our subscribers tell us it's the only cycling publication they read cover to cover.

On the next page is a form you can fill out to either get a free sample or subscribe. Go for the subscription, though. If what you've read here sounds interesting, then you'll like it.—Grant

Become a Rivendell Member for \$20. Get a year's subscription to the Rivendell Reader, money-saving coupons, and seasonal Catalogues.

LOOK WHAT YOUR \$20 GETS YOU:

1. MEMBER PRICES ON EVERYTHING IN THIS CATALOGUE

The prices listed are the low, Member prices. Non-members pay \$5 more per item.

2. RIVENDELL COUPONS

Every now and then, a couple of times a year, we'll print Rivendollars in the *Reader*. These are good toward qualified purchases, but only members can use them.

3. OUR QUARTERLY NEWSLETTER

It's called the *Rivendell Reader*. A typical issue is 32 to 40 pages long, and contains stories, articles, and interviews that you absolutely, positively will not read in any other cycling publication.

4. TWO ISSUES OF OUR CATALOGUE

If you like what you see here, you'll like the other issues too. We aim to have one come out every season of the year.

5. TEN DOLLARS OFF YOUR FIRST ORDER

If you fill out the form below, and place an order as well, you can take \$10 dollars off the total. There's no funny business. Fax or mail orders only, please.

Note to Members: You can extend your membership by a year or more, and get the same great deal.

Name _____ Member # if renewing _____

Mailing Address _____

City _____ State _____ Zip _____

Ship to, if different _____

Work phone: (_____) _____ Home phone: (_____) _____

Fax: (_____) _____ Email: _____

MEMBERSHIP ORDER FORM	TOTAL
I'd like to join Rivendell for one year. (\$20)	
I'd like to join for two years. (\$30)	
Sign me up for three years. (\$35)	
Sign me up for 99 years. (\$200)	
Foreign subscriptions are \$25 per year.	

P.O. BOX 5289 • WALNUT CREEK, CA 94596

PHONE: 925-933-7304 • FAX: 925-933-7305 • FAX TOLL-FREE IN US: 877-269-5847

PAYMENT

Check or Money Order No.: _____ Amount: \$ _____

Credit Card No.:

Expires (MM/YY) - WE ACCEPT VISA & MASTERCARD

A brief business history & trivia

I (Grant) worked for Bridgestone Cycle (U.S.A.), Inc. for ten years, from late '84 to late '94, when Bridgestone closed its U.S. office. I designed and spec'd bikes there and headed up the small marketing department. Over the years, and heavily under the influence of the Japanese engineers who taught me a lot and treated me well, I came to believe certain things about bikes, and those things stuck with me. One was the importance of safety. Bridgestone was nuts for safety and testing, and there were many instances when our competitors were using a part that we couldn't use, because although it passed general industry tests, it didn't pass our even more strict internal tests. It still believe safety is the most important thing we can offer. I'm not saying we'll never have a part fail, and I'm not insinuating that you're taking a risk buying from other sources. All I'm saying is that safety is our first concern, and that is why we don't sell handlebars that weigh 200g. Once safety's taken care of, you can move on to more glamorous things, but you shouldn't go there first.

While at Bridgestone, I came to know Nitto, a small company by international bicycle company standards, with just 48 employees. It has been owned and run by the Yoshikawa family since its start in 1923. Nitto's standards for strength are not only unsurpassed in the bike industry, but are so high that they're in their own league. And so it's surprising that they also make the most beautiful bike parts (racks, bottle cages, handlebars, stems, seat posts). Nitto's problem is capacity. They make parts slowly and to order, and with few exceptions, they make then 50 at a time, or maybe 100 at a time. We will do our best to keep Nitto stems, handlebars, bottle cages, and racks in stock, but you may have to wait for your Nitto piece, so please plan ahead.

If Rivendell had a seed, it was the Bridgestone Owner's Bunch (BOB), a group of 3,900 Bridgestone loyalists who understood bicycles and fashion and function slightly better than most folks do, and bought things from us that most of our dealers didn't understand, buy, or support. When Bridgestone's doors closed, the BOB members became my mailing list. Our offerings have grown a hundredfold, but the approach has remained constant. We've never included something in our catalogue just because it's popular. Popular stuff can be good, but so often something is popular for reasons that have nothing to do with how good it is.

I needed money to start Rivendell, so I borrowed some, cashed in half of my 401K, and sold stock to friends who either had foolish faith or an inability to say No when I asked them if they'd buy stock at a dollar a share. It hasn't been a great investment for them—by the way shares are valued, it's still worth about the same. Anyway, after gathering money from every source I knew, I started Rivendell with \$89,000 on October 17, 1994. It was an exciting time, because my mom died on September 25, Bridgestone shut down the 30th, and my wife and I had our second daughter on October 11. I don't know how we ever survived. I didn't know anything back then. The inventory was in my back yard and garage, the office was the garage, and you couldn't even see the floor. The fact that we've survived ten years is amaz-

ing, because I've made so many mistakes along the way. One key to our survival has been that we've kept our focus. We still sell only leather saddles, canvas bags, lugged steel frames, and hole-less, grooveless silver handlebars and matching stems. While other makers move in the direction of amorphous bicycle frames and bicycle parts that mold and flow into one another in a scientifically ergonomic way, we're keeping them right, and to my way of thinking, smarter, more beautiful, and better. It's a style we're sticking with.

We've always had a good crew here, and employee turnover is not too high. We lost more employees in our first five years, when they just couldn't afford to work here. But in the last five years wages have increased some, and we've managed to get a crew that seem right and sort of settled. Our backgrounds are all over the map, but we're all nice, sincere, and and really, really try to be helpful.

Last year we made a profit for the first time in 9 years. This year, it looks like it'll be back to normal. You might wonder how a company can survive without making a profit. It has to do with debt and cash flow. I don't fully understand it myself, which is part of the problem, but no doubt many of you do. In any case, we seem to be stable, but overall this business adds a lot of stress to my life, and the only thing that would make it less stressful is no business at all. The stress comes from thinking things like, "We have 6,500 customers, and in a month all of them will have bought everything they'll ever need from us, and we aren't getting new customers fast enough to keep going," and "Business is too complicated. There's too much to do, too many things, I just want to be old so I can retire."

But, I really love it here, and if I had a million dollars and no mortgage and college tuition for my girls paid for, I'd still do exactly what I'm doing, exactly the same way. Also, I am truly not qualified to do anything else. For me, this is it, period, and I'm glad to have it.

We've tried to put into this catalogue special things that you can't easily find other places, and sometimes not at all. Our business depends on repeat business, because our customer base (our "membership") is only 6,500. If you're one of them, we consider you to be among the elite. If you're not, and you like what you see in this catalogue, please consider subscribing to the *Rivendell Reader*, our quarterly. That way, we'll be able to send you good stories, good reading on topics that for the most part are bicycle-related, and when a new catalogue comes out, you'll get that too. We have to keep hustling, and we'd like you to hustle along. Bicycles are changing. Some of the changes I guess could be construed as true progress, but a lot of it's not. Every year there's a new crop of newly retired engineers from other fields who try to reinvent the way we ride bikes. Every year the big companies push the technology ever forward, and the direction is clearly the automatic bicycle. We're not living in the stone age, but the bikes and bike parts we like are somewhere in between those kinds. Everybody should ride a bike, who knows how. Everybody should have a good bicycle. Variety is good, so maybe two.—Grant

• No. 15 Winter '04 - '05 •

Name _____ Member # if known _____
 Mailing Address _____
 City _____ State _____ Zip _____
 Ship to, if different _____
 Work phone: (_____) _____ Home phone: (_____) _____
 Fax: (_____) _____ Email: _____

IF SOMETHING IS OUT OF STOCK

____ Ship back-ordered items as they become available (from now on, backorders shipped freight ppd).
 ____ No backorders, just send me what's in stock.

No backorders on items less than \$20. That's because we pay the freight on backorders, and our shipping costs easily eats all of the profit. No int'l backorders.

If no line is checked, we assume backorders are preferred.

SHIPPING & HANDLING

Orders up to \$149, \$8. \$150+: FREE (exc. noted)
Next Day.....\$35 2-Day.....\$20 3-Day.....\$12
Rims.....\$15 (any qty) or Wheels.....\$15 (each)

International **Ground Air**
 Canada (USPS unless you request UPS).....\$15 \$25
 All Other Countries.....\$25 \$50

P.O. Boxes, AK & HI: \$10 Priority Mail, restrictions apply.
 Call for int'l rates on shipping frames, wheels, bicycles.

ITEM #	BRIEF DESCRIPTION	QTY.	SIZE	\$ EACH	TOTAL

	Subtotal	
	Tax (CA only)	
Shipping (\$8 up to \$149; \$150+, FREE-(no rims, frames, bikes)		
Take \$10 discount if you renew or sign up now		
GRAND TOTAL:		

P.O. BOX 5289 • WALNUT CREEK, CA 94596
 PHONE: 925-933-7304 • FAX: 925-933-7305 • FAX TOLL-FREE IN US: 877-269-5847

PAYMENT

Check or Money Order No.: _____ Amount: \$ _____

Credit Card No.:

Expires (MM/YY) - **WE ACCEPT VISA & MASTERCARD ONLY**

Hours, Visiting Tips, Directions, and Policies

Telephone Hours

M-F, 9:00 am to 5:30 pm Pacific time. We're here earlier and later, but these are our phone hours. We return messages!

Visiting Tips

We have a shop, warehouse, phone area, and a new showroom that's still coming together. Our visiting hours are the same as our phone hours, more or less. Call first, and come on by. We're a friendly lot!

To Find Us

From the south or west: Take 680 N to the Ygnacio Valley Road exit. East on Ygnacio a minute to North Main Street. North on Main, and look for parking, because there's no parking by us. We're at 2040 North Main, cell block #19. Up the hill between the bakery outlet and the blue brick building, around to the left, then halfway down on the right, before Discount Mufflers.

From the north: Take 680 S to the Geary/Treat exit. Left onto Main until you hit Pringle. U-turn at Pringle, then turn right after the bakery outlet, but try to park on the street. We're up the hill between the bakery outlet and the blue building, around the left side, about halfway down.

From Walnut Creek BART: We're a 5 minute walk. Walk out the NE side of the lot, take Pringle to N. Main, cross N. Main and go up the path between the bakery outlet and the blue building. Stay to the left of the corrugated metal building, find No. 19.

What To Expect & Where To Park

We have three 1000-square foot adjoining spaces. Park in front of 17, 18, 19 and 20.

Will Calls

Call first so we can have your order ready.

Stocked Items

We try to keep stock of everything in this catalogue, but we may temporarily run out of some items. Bear in mind that many of the items we sell are rare, esoteric, or just plain too weird for distributors to stock in good quantities; and others are made or imported especially for us. Backorders will only be issued on out of stock items listing for more than \$10. Backorder freight is free. The prices listed are good until the next catalogue or price update in the *Reader*.

Returns, in General

If you aren't completely happy with what you buy from us, you have 60 days to return it for a full refund by check or credit card (as you originally paid).

Payment

Visa or Mastercard, personal checks or money orders. We don't hold checks to wait for clearance, but in 6 years, we've never had an uncollectible one. If you're the first, the world will know of it! All orders shipped to California get charged your local sales tax.

Shipping/Handling Charges

Domestic Orders

Standard: \$8 per delivery for in-stock merchandise. Shipping is free for orders above \$149. Allow 7-10 days for delivery.

3-Day: \$12

2-Day Air: \$20

Next Day: \$35.

All 3-2-1-day orders must be received by 12:00 Pacific time. If you're on the east coast, fax it in to 1(877-269-5847). We'll bust our behind for you, but cannot guarantee delivery.

Back Orders: Freight postage paid.

Wheels: \$15 per wheel, unless it's part of a bike.

Frames: \$35, shipped UPS ground. \$50 for 3-day Select.

Bikes: \$50 (lower 48; other, call), shipped UPS ground.

International

UPS only

Ground to Canada: \$25

Air to Canada: \$50

Int'l Air: \$50

Frames & Bikes: Call

PRICING

Catalogue prices are member prices. Non-members pay \$5 more per item. That's usually a decent deal anyway (except on small items). It sounds harsh, maybe even cruel, but it's our way to get you to join. Joining is cheap and easy, and you get your member fee back starting with your first order.

\$1



© 2004 RIVENDELL BICYCLE WORKS

Rivendell Bicycle Works
2040 North Main Street #19
Walnut Creek, CA 94596

PRSR STD
U.S. POSTAGE
PAID
WALNUT CREEK CA
PERMIT #816