



RIVENDELL BICYCLE WORKS

CATALOGUE & PRICE LIST

No. 03

SUMMER 1997 → → FEB. 16, 1998

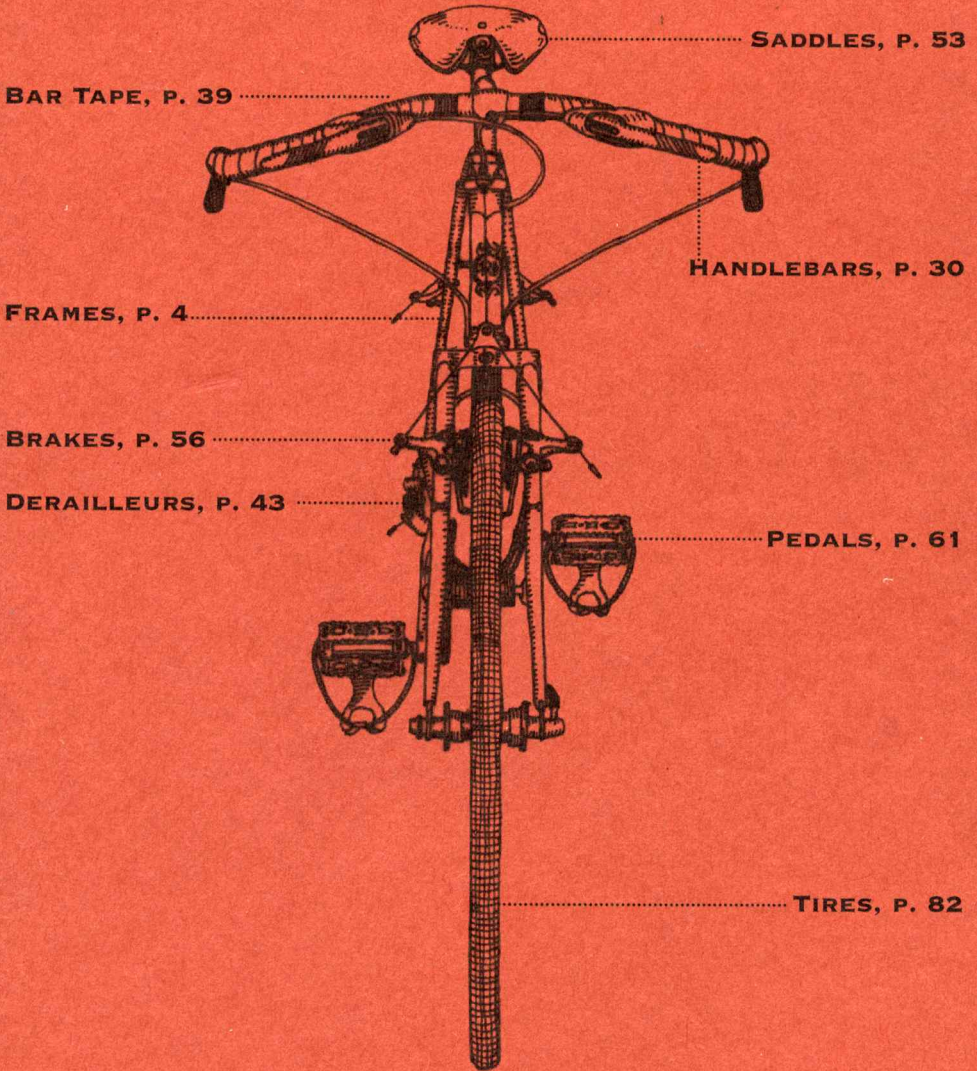

👉 **SIMPLE • PRACTICAL • PROVEN** 👈

gear for the traditionalist, the technophobe, and others



FEATURING

FINE BICYCLE FRAMES & PARTS & BOOKS AND BOOMERANGS
SUBSTANCES, SUNDRIES, SARTORIALS AND
REFRIGERATOR MAGNETS THAT PUT ALL OTHERS TO SHAME.

"Buy the product that contains the product influenced by the fine folks." — Jon Carroll

GUARANTEE



We sell only things we ourselves use and are completely familiar with, so feel free to ask us anything about anything. If you buy something and aren't happy with it, you have up to a year to return it for a refund or credit, whichever you prefer; we prefer the credit. We want you to like and be really happy with our stuff, and we selected our menu with that in mind.

FAIR-TO-ALL PRICING



We (Rivendell employees) pay the same prices you do, and we don't have "pro deals" to bike industry employees or "bro deals" to friends and family. Also, you can be sure your purchases aren't subsidizing television or movie prop deals, or freebies to an insider elite, millionaire pro athletes, or Hollywood stars. It would be ungracious for those people not to accept such generosity, but rest assured that if you see Demi Moore or Brad Pitt or Bill Gates pedaling a Rivendell or carrying an ACME wallet, they paid the same price you did. (And if you do see that, please let us know.) We've further made a conscious effort to avoid prices that look lower than they are (\$39.95 etc).

MONEY-GIVING



We're trying to form good habits now, when money's tight, so if money ever isn't we won't be able to attribute any bit of our good fortune to stinginess. So this year we'll give a thousand dollars to Bicycle Inter-Community Action and Salvage (BICAS), an organization run by Bstone 1994 catalogue cover model and crack bike mechanic Kim Young. She teaches bicycle mechanics and assembly to local, at-risk boys and girls, and sells rebuilt bikes cheap to people who need the transportation. We donate another \$500 to \$700 to Battered Women's Alternative (BWA), a local organization that helps hurt women and families get on a good path. We'll give more as we're able to.

Rivendell Bicycle Works



WE'RE A MAIL ORDER COMPANY for bike riders who prefer traditional, classical bicycles and accessories to today's ever-changing, high-tech fare. It doesn't have to be all or nothing, though. You can like your clipless pedals and still prefer friction shifting, and you can sit on a leather saddle and still like ERGO. But we focus on the old normal stuff, and most of what we offer you can't find at the big mail order places or your local bike shop. Years ago you could, but you can't now.

It's not us versus them, retro versus techno, old versus new, and it's not niche marketing in the tactical sense, either. We just offer the same gear we use and like. In general, it's simple gear, because nothing you ask a bicycle to do is all that complicated; it's practical in the sense that it fulfills a fundamental cycling (not just psychological) need; and it's proven—much of what we offer was born before we were, and even new items borrow heavily from materials and designs that have been around for years.

We aren't trying to design the future of bikes, and we don't rate bikes and parts by how much bad technique they let you get away with, or how easy they are to master your first time out. Point-and-pedal bikes get a lot of people into this sport, out of their automoboxes (thanks, Mason), and that's terrific. But in their quest to "grow the market," most of today's bike companies—just like most big companies in other fields—have discontinued the best technology and most refined designs from the past. We're just trying to keep it in circulation so riders who were raised on it and still prefer it can still find a source. And so new riders will be exposed to an alternative, and if they find it suits them, they won't have to search all over kingdom come and pay collectors prices to get it. You shouldn't need a trust fund to afford a really nice bike.

Some of the components we offer *are* endangered and collectable, but they're no less rideable for it, and their scarcity isn't what makes us like them. We like bikes because they're fun to ride. Collecting, nostalgia, and display-casing have their place, but it's not our thing. It costs too much, takes too much time, takes too much space, and makes you sweat for the wrong reasons.

We carry lugged steel frames, leather saddles, wool clothing, waxed cotton saddle bags & panniers, standard pedals-clips-and-straps; assorted curved handlebars; chains and freewheels, cold-forged cranks, sidepull and cantilever brakes, frictionable thumb, downtube, and handlebar-end shifters, cotton handlebar tape, books, tools, beeswax, boomerangs, certain soaps, the world's best refrigerator magnets, and Edward Lear's 1846 classic, Book of Nonsense.

We have all you need to build and equip your bike, too, but there's no gratuitous high tech, and our selection is narrow. Every item earned its spot, either by being the best, the best value, or the last of its kind available. This wouldn't work if we were a normal bike shop dependent on local business, but our customers are scattered around eleven countries. We rely heavily on word-of-mouth advertising, so if you know other cyclers who might like this approach please tell them about us or us about them. And if you can suggest a product we should carry or a service we should offer, or if you have any suggestion whatsoever, we want to hear it. We need your help to get better.

Keep this catalogue! We plan to print another in February of next year, but you never know. In any case, if you lose it, call up and we'll mail a replacement that day. Prices are good until our next one next year. Thanks for giving us a try.

—Grant, Peter, Mary, Gary, and Joe

Table of Contents

JOIN RIVENDELL?	3
RIVENDELL ROAD & LONGLOW FRAMES	4
RIVENDELL ALL-ROUNDER FRAME	11
SIZING A FRAME	13
RIVENDELL MOUNTAIN FRAME	14
METAL, REYNOLDS 753, LUGS	18
BAGGAGE	24
WALLETS & SADDLEBAGS	28
HANDLEBARS	31
STEMS	41
FRONT DERAILLEURS	43
GEAR SHIFTING & SHIFTERS	44
REAR DERAILLEURS	49
SADDLES & ACCESSORIES	53
SEAT POSTS	55
BRAKES	56
PEDALS, CLIPS, & STRAPS	61
CHAINS	64
FREEWHEELS	65
CRANKS	66
WILLOW CHAINRINGS	67
BOTTOM BRACKETS	69
A WORD ABOUT Q FACTOR	71
SUNDRIES & SUBSTANCES	72
TOOLS	74
WEARS	76
SAFETY STUFF	77
BOOKS	78
PROMOTIONAL WEAR & KNICK KNACKS	80
SOAPS	81
TIRES	82
HUBS • RIMS • WHEELS	84
RACKS & CAGES	85
RAIN WEAR	86
WOOL	87

RIVENDELL STAFF (TWO FULL-TIME, THREE PART-TIME):

GRANT P., PETER K., MARY A., JOE B., GARY B. (JOE & GARY ARE UNRELATED.)

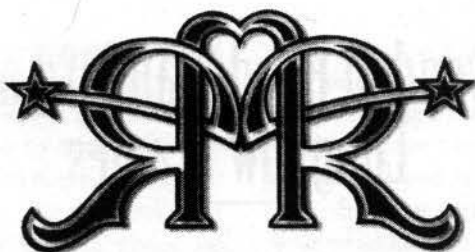

Why Join and Subscribe?

Now more than ever the direction bicycles are headed is dictated by large companies using the glamour of space-age technology to attract new cyclists to the sport, and the lure of constant changes, always masquerading as improvements, to get you to discard your current bike parts in favor of new ones. (A common practice of mature industries in any field trying to grow in a flat market.) It's impractical for those companies to address the simpler needs of other cyclists, so we try to, and it works only with your membership dues and patronage.

A one-year membership/subscription costs \$15 and gets you four issues of our 40-page *Rivendell Reader*. It's a low-tech, non-competitive, practical, and we hope provocative look at bicycles and riding. It doesn't cover travel,

stretching, cross-training, diet, recipes, or racing/hero worship—not that there's anything wrong with those things, but they're not our taste. We also throw in some non-cycling articles, too, since you can be nuts about bikes but still have other interests.

Membership also gets you the best prices on everything we offer, as you'll see as you check the prices. What's more, each issue of the *Reader* has coupons you can use toward purchases, so it's easy to recoup a good chunk of that \$15 on your first order.

You can join by phone, fax, or mail; by check, Visa, or MasterCard. If \$15 is too much for your budget, send as close to \$15 as you can afford, and we'll sign you up. Thanks. You can use this form if you want.

Name _____
Address _____
City _____ St. _____ Zip _____
Master or Visa # _____ Exp _____
Day Phone _____
If you live in California, which county? _____

Rivendell Road Standard and LongLow Frames

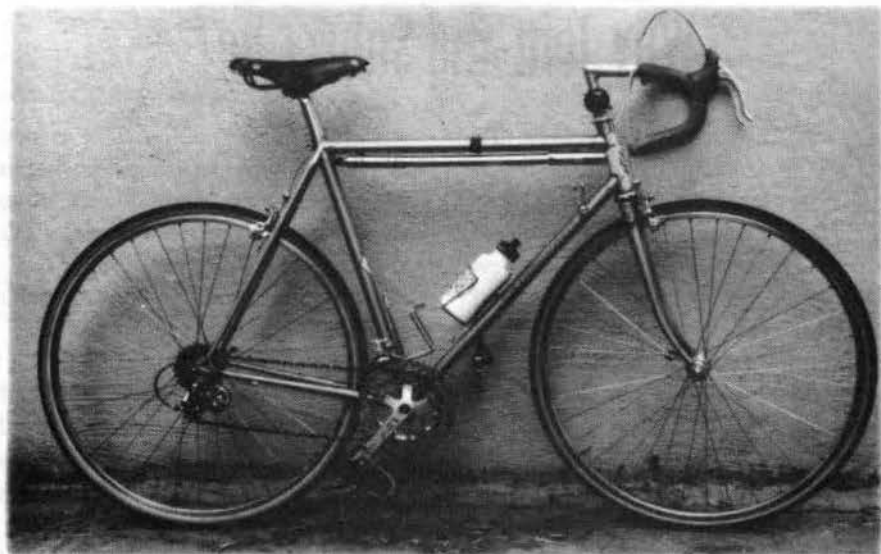

Road Standard (Grant's bike)

Most of the changes in road frame design during the past 20 years have been subtle, but the cumulative effect of shorter chainstays, steeper angles, loss of eyelets, and vertical dropouts has made the modern road bike less versatile than a 1970's model. Yet no more raceworthy.

The easily overlooked and rarely discussed details make the difference—the height of the brake bridge, the length of the fork and the distance from the brake bolt hole to the underside of the crown, and the internal dimension of the crown and the chainstays just behind the bottom bracket. Magazine road tests rarely mention these details, but they're important because they determine the tires the frame will accept, and tires, more than

any other single component, determine what kind of roads or trails the bike is suited for.

Dropout eyelets are another thing. It used to be that even racing frames had them, but now, to save a fraction of an ounce and to present a clean frame, virtually all production makers have eliminated eyelets on their sporty bikes, and with no eyelets, there's no convenient way to mount racks or mudguards. When you're shopping for a road bike, you don't imagine yourself carrying loads or riding in the rain, but eyelets weigh so little and offer so much, it seems a shame to eliminate them altogether. Eight years from now your riding habits may change, you may live in Seattle, you might shop by bike, or want to tour ... and you'll want eyelets. Or you may decide it's no

🌀 CATALOGUE & PRICE LIST 🌀

longer acceptable to spray grimy road water on your clubmates and riding pals. Some clubs require fenders.

We aren't trying to turn nice zippy road bikes into workhorses. The point is, you can have the features that increase versatility without giving up any of the qualities that make a good road bike feel so fine. The Rivendell Road Standard frame is as raceworthy as any frame, but it is so much more versatile than a typical modern race frame, it's like having another frame entirely. The LongLow, even more so. Though we sort of promote it as a versatile 700c bike frame, the LongLow has specifications that in any era other than the extreme one we're in now, would brand it as a racehorse.

These frames (and all our frames) are made from Reynolds 753 steel tubing drawn to our own specifications, and the tubes are heavier than the stock Reynolds 753 tubes and other modern superlight steel tubes. But the extra material is well-placed: The upper down tube butt is 100mm, because the most vulnerable part of any tube on a bike is the underside of the upper portion of the down tube, and the long butt protects this vulnerable area. A tube won't buckle there without you running into something, but accidents happen, and the long butt makes sense for a frame built to ride hard in all conditions for a long time. Also, the shifter boss is brazed on within the butted area, and the base corners are rounded, which fairly eliminates the chance of a

fatigue crack at a corner.

The Rivendell frames has a shallow seat tube angle to keep your weight back, which in turn reduces weight on your hands and strain on your shoulders. Since the shallow angle shifts your weight to the rear, we've compensated with a slightly shorter than normal front-center (the distance between the crank axle and the front hub axle), and used longer chainstays to shift the rear wheel slightly farther back. The slightly shorter front-center with a

longer rear-center is the opposite of most modern frames, which tend to be short in the rear, long in front. Those bikes feel funny to me (Grant), but that may be the curse of having paid too much attention on too many test rides over the years. In any case, the bikes I like tend to be shorter up front and longer in back. (Ritchey road frames are that way; and Pino Morroni frames are this way in extreme.) Following are some other features.

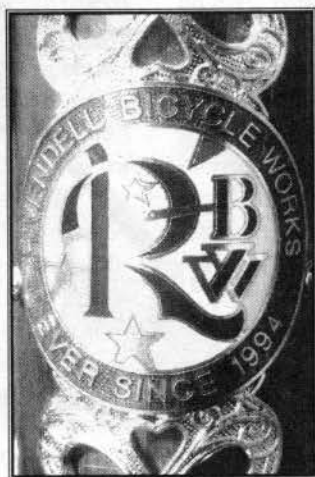

This is our name plate. It is cloisonne, multi-colored, weighs 13g, and is affixed to the head tube by two tiny screws (not included in the listed weight).

EXTENDED HEAD TUBE AND FORK STEERER

The standard Rivendell frame has a head tube 15mm taller than the top of the lug, and the steering tube is 10mm extra longer (the gap is filled with a machined spacer). These features allow you to get the bars higher than you can with a standard frame (10mm steerer+ 15mm head tube = 25mm higher). So if you ordinarily ride a 56 road frame, you can get the bars as high as they'd

be on a 58.5 frame. We also slope the top tube up on both the Road Standard (1°) and LongLow (2°) to raise the bars without making the bikes look funny. (1° up x 55mm = 10mm up)

The taller head tube also effectively shortens the top tube by a few millimeters without shortening the wheelbase or front-center.

things happen when you raise the bars.

LOW BOTTOM BRACKET

Conventional wisdom says a lower BB makes a bike handle better and easier to control at high speed, and we buy into that one all the way. In BB heights, 265mm is considered low, 275mm is considered high. To deter-



LongLow

We like a higher bar position, and in general suggest riding the bars within an inch of the height of the saddle—an impossibility on most off-the-shelf bikes, unless you use a non-off-the-shelf stem with a longer quill or a higher rise. A higher bar opens you up at the waist, so it improves breathing. It tends to lift an oversized belly out of the way of your thighs. It brings the drops into a more useful zone. It takes weight off your hands and shoulders; and it reduces strain on your back. Good

mine the bottom bracket height you measure the height of the hub (the wheel radius), and subtract the drop—the distance the center of the bottom bracket falls below the centerline of the wheels. In the case of a road bike with skinny 700c tires, the wheel radius is

about 336mm. On a typical road frame with 70mm of drop, this yields a bottom bracket height of 266mm—pretty good. But once you put on a tire of truly useful, all-round dimensions (an Avocet 700x32, for instance), the BB jumps to



LongLow Fork Crown

275mm, which is too high for our taste.

Both the Road Standard and LongLow accept a huge range of road tires, but we designed specifically for tires with a minimum diameter of 680mm diameter (a Ritchey 700x25, for instance), and gave them 80mm of drop. With such a tire, the bottom bracket height is 260mm; a good deal lower than most bikes, and that's one reason they handle so nicely. Do you have to pay attention to pedal clearance around corners? Of course. But you shouldn't pedal through high-speed corners, anyway. You'll corner faster with more control if the bottom bracket is lower, and the bike feels so much better. The low bottom bracket and longer chainstays add a measure of steadiness that's apparent on a ride, but hard to describe. The tighter the S-turns and more frequent your weight shifts, the more you'll notice the difference. There's no "stiff" zone as you shift the bike from leaning hard left to leaning hard right. It's a good feeling!

LOWER STANDOVER HEIGHT

For any given frame size, a shallower seat tube angle and a lower bottom bracket result in a lower top tube, and Rivendells have both a lower bottom bracket and a shallower seat tube angle than most frames. If you currently ride a 56cm frame and have an inch of crotch clearance, you'll probably be able to straddle a 58cm Rivendell. Maybe a 59.

HORIZONTAL DROPOUTS ...

... allow you to increase or decrease the effective chainstay length by about 10mm. Slide the wheel back for added tire and fender clearance, or push it forward, or ride it in the middle.

There's nothing wrong with vertical dropouts, but the most likely explanation for their popularity is that the chainstays on most road bikes are so short you can't slide the wheel forward to remove it, because it hits the back of the seat tube. A vertical dropout lets the wheel drop straight down without moving forward, solving the problem short chainstays created. A better way is to lengthen the chainstays in the first place, but short chainstays impress a lot of people, so makers are reluctant to do that. We prefer horizontals, but not by a landslide, and if you want verticals, we'll do it for a small (\$25) upcharge. Horizontals aren't cheaper to build with than verticals. We charge more because the change from spec requires the tubes to be cut differently than we normally do, and you have to pay for that.

Starting sometime in 1997 we'll use a forged dropout designed and made specifically for Rivendells and Herons. It's made in Italy by Tecnociclo.

CLEARANCE FOR 35C TIRES

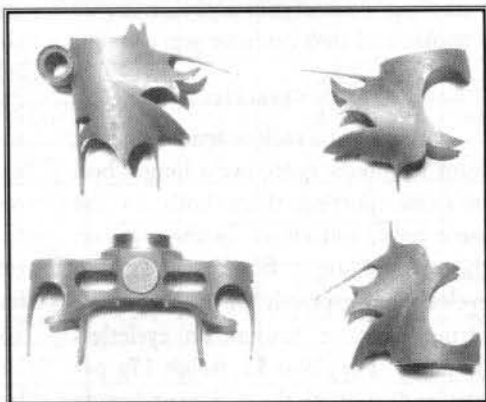

Richard Sachs designed the lugs for us. The points are well out of the stress areas, the tubes are well supported, and despite the fanciness, they're quick to braze. The crown weighs just 100g, has rounded windows and properly shaped front and rear points to eliminate stress, and is thoroughly tested. The top has a waist and epaulets.

RIVENDELL BICYCLE WORKS

(ROAD STANDARD), OR
35C TIRES WITH FENDERS (LONGLOW)

Most modern road bikes are out of their element off the race course because they don't have clearance for tires larger than 700x28. Rivendell road frames fit tires up to 700x35, so you can ride them not only on any road, but most fire trails, too. There are many benefits to a little more air. You can safely ride lower pressures, adding comfort on rough roads and traction in turns and in the rain. A slightly softer tire is probably faster than a skinny hard one on rough surfaces, too, because the tire deforms when it hits a bump and rolls right on over it, whereas a hard skinny tire will send the shocks right up to your hands and arms. Another plus with higher volume tires is their broader range of rideable air pressures. Who hasn't flatted without a spare or repair kit, and had to ride as far as possible between pump-stops? You can ride a slow leak farther if your tires are fatter.

Even if you don't plan to ride chubbies, the added clearance makes room for fenders, or gives the wheel some wobbling room if you happen to break a spoke, and that can save you a walk.

DROPOUT EYELETS! ...

... to mount a rack or fenders. If you want to mount both, use a longer bolt in front (putting them both on the same bolt), and either do the same on the rear, or use a Blackburn Custom eyelet, made expressly for the purpose of fitting racks or fenders on eyeletless dropouts. They cost \$5, weigh 11g per pair, and we stock them. The underside of the brake bridge is tapped, so you can

ream a hole in the fender and mount it directly with a really short pan-head screw (M5 thread). That pulls it farther from the tire than a conventional mounting method allows.

NOTE ABOUT TOE CLIP OVERLAP...

On smaller Rivendell road frames and some of the short top tube models, when your foot is at 3:00 and the wheel is turned enough, the tire will indeed touch your toe clip or shoe. Don't worry about it—if you turn the wheel that much when you're going faster than 5 mph, you'll crash way before the toe hits. Adding a front fender decreases this clearance further (as will a bigger foot or tire), but it still isn't a problem at riding speeds. Occasionally having toe clip overlap is noticeable when starting off, or doing a track stand at a stop light, but that's a small price to pay for a better ride.

SMALL BIKES & WHEEL SIZES

Our 50cm and 51cm road frames are designed for 26-inch wheels, because 700c-wheel frames of this size have too many compromises—high bottom brackets, long top tubes, too shallow head tubes, too steep seat tubes, or some combination thereof. Going to a 26-inch wheel (we use the so-called "mountain" 26-inch) allows us to design the frame correctly without having to worry whether or not the front wheel's going to hit the down-tube. Our 26-inch wheel road frames have vertical dropouts, because horizontal dropouts don't work with those particular geometries. The reasons take too long to explain here, but if you're curious, please ask.

Top Secret Geometry

subject to change without notice

ROAD STANDARD

SIZE C-T	ST ANGLE	HT ANGLE	FORK RAKE	TOP TUBE	CHAIN STAY	BB DROP	REAR SPREAD	TT/ST Ø	DT Ø
50	74	72	4.0	52.5	41.5	4.5	130	28.6	28.6
51	74	72	4.0	53	41.5	4.5	130	28.6	28.6
52	73.5	72.5/72	4.5/5.0	53.5/52.5	42	8	130	28.6	28.6
53	73.5	72.5/73	4.5	54/53	42	8	130	28.6	28.6
54	73	73	4.5	55/54	42.5	8	130	28.6	28.6
55	73	73	4.5	56/55	42.5	8	130	28.6	28.6
56	72.5	73.5	4.25	57/55.5	43	8	130	28.6	28.6
57	72.5	73.5	4.25	57.5/56	43	8	130	28.6	31.8
58	72.5	73.5	4.25	58.5/56.5	43	8	130	28.6	31.8
59	72.5	73.5	4.25	59/57	43.5	8	130	28.6	31.8
60	72.5	73.5	4.25	59.5/58	43.5	8	130	28.6	31.8
61	72.5	73.5	4.25	60/58.5	43.5	8	130	28.6	31.8
62	72	73.5	4.25	60.5/59	44.5	8	130	28.6	31.8
63	72	73.5	4.25	61/59.5	44.5	8	130	28.6	31.8
64	72	73.5	4.25	61.5/60	44.5	8	130	28.6	31.8
65	72	73.5	4.25	62.5/60.5	44.5	8	130	28.6	31.8

LONGLOW

SIZE C-T	ST ANGLE	HT ANGLE	FORK RAKE	TOP TUBE	CHAIN STAY	BB DROP	REAR SPREAD	TT/ST Ø	DT Ø
52	73	72	5	53.5	44	8	130	28.6	28.6
53	73	72.5/72	4.5/5	54.5	44	8	130	28.6	28.6
54	72.5	72.5/72	4.5/5	55.5/54.5	44	8	130	28.6	28.6
55	72.5	72.5	4.5	56/55	44	8	130	28.6	28.6
56	72.5	73	4.5	56.5/55.5	44	8	130	28.6	28.6
57	72	73	4.5	57/56	44	8	130	28.6	28.6
58	72	73	4.5	58/57	44	8	130	28.6	28.6
59	72	73.5	4.25	58.5/57.5	45	8	130	28.6	28.6
60	72	73.5	4.25	59/58	45	8	130	28.6	28.6
61	72	73.5	4.25	59.5/58.7	45	8	130	28.6	28.6
62	72	73.5	4.25	60.5/59	45	8	130	28.6	31.75
63	72	73.5	4.25	61/59.5	45	8	130	28.6	31.75
64	72	73.5	4.25	61.5/60	45	8	130	28.6	31.75
65	72	73.5	4.25	62.5/60	45	8	130	28.6	31.75

ALL-ROUNDER

SIZE C-T	ST ANGLE	HT ANGLE	FORK RAKE	TOP TUBE	CHAIN STAY	BB DROP	REAR SPREAD	TT-ST Ø	DT Ø
42	74	72	4	49.5/47	42.5	5	135	28.6	31.75
46	73.5	72	4	51/49	42.5	5	135	28.6	31.75
48	73.5	72	4	52/50.5	42.5	5	135	28.6	31.75
50	73	73/72	3.5/4	52.5/51	43	5	135	28.6	31.75
51	73	72.5	4.25	53.5/52	43	5	135	28.6	31.75
52	73	72.5	4.25	54.5/53	43	5	135	28.6	31.75
53	73	72.5	4.25	55/53.5	43	5	135	28.6	31.75
54	72.5	73	3.5	55.5/54	43.5	5	135	28.6	31.75
55	72.5	73	3.5	56.5/55	43.5	5	135	28.6	31.75
56	72.5	73	3.5	57/55.5	43.5	5	135	28.6	31.75
57	72	73	3.5	57.5/56	43.5	5	135	28.6	31.75
58	72	73	3.5	58.5/56.5	43.5	5	135	28.6	31.75
59	72	73	3.5	59/57	43.5	5	135	28.6	31.75
60	72	73	3.5	59.5/57.5	43.5	5	135	28.6	31.75
61	72	73	3.5	60/58	43.5	5	135	28.6	31.75
62	72	73	3.5	60.5/58.5	43.5	5	135	28.6	31.75

MOUNTAIN

SIZE C-T	ST ANGLE	HT ANGLE	FORK RAKE	TOP TUBE	CHAIN STAY	BB DROP	REAR SPREAD	TT-ST Ø	DT Ø
16	73	72	3.5	54.5/53.5	43	4.5	135	28.6	31.75
17	73	72	3.5	55.5/54.5	43	4.5	135	28.6	31.75
18	72.5	72	3.5	56/55	43	4.5	135	28.6	31.75
19	72.5	72.5	3.5	56.5/55.5	43.5	4.5	135	28.6	31.75
20	72.5	72.5	3.5	57/56	43.5	4.5	135	28.6	31.75
21	72	72.5	3.5	58.5/56.5	43.5	4.5	135	28.6	31.75
22	72	72.5	3.5	60/57	44	4.5	135	28.6	31.75
23	72	72.5	3.5	61/57.5	44	4.5	135	28.6	31.75
24	72	72.5	3.5	62.5/58	44	4.5	135	28.6	31.75

Rivendell All-Rounder



This is our most versatile frame—a jack of all trades, master of most, and for touring, commuting, and most trail and fire-road riding, it is perfect. When you build it up with either Moustache or drop handlebars and bar-end shifters, it is clearly neither a conventional road nor mountain bike. Its most recent inspiration was the Bridgestone XO-1, made in both 1992 and 1993. But the XO-1 itself was modeled after the French 650B-wheeled touring and the British “rough stuff” bikes. These practical breeds go back at least 50 years, and have been unaffected by the same marketing forces that, in the mainstream market, have made extremism the norm.

Our All-Rounder is pretty much a light road frame dimensioned to fit the widely available 26-inch mountain

bike wheels, and has enough strength to handle anything short of the most abusive off-road riding.

The combination of road geometry and 26-inch mountain bike-sized wheels lets a lot of wonderful things happen. You get all the strength and weight advantages of the smaller wheel—while increasing your tire choices—for the best fit and ride.

And 26-inch wheels are inherently much stronger and lighter than 700c wheel, and offer a wider choice of tires, from 26x1-inch to 26x2.35-inches, with room left over for mudguards (with tires to 26x1.9”).

Although we don’t call the All-Rounder a mountain bike, a rider with good skills and only fair judgment can ride it all over mountainous terrain. (The World 24-hour Off Road Record is held on the Bridgestone XO-1.) If

RIVENDELL BICYCLE WORKS

you don't currently have a standard mountain bike, you may find no need or desire to own one after riding an All-Rounder. And if you do have a standard mountain bike, you may still prefer to ride your A/R anywhere you go off-road.

The All-Rounder frame seems made for whatever parts you put on it, and everybody seems to have a special plan for it. With swept-back bars, fenders and racks, it's a smart commuter; with Moustache H-bars and midsize knobbies, it's uncatchable on fire roads; with drops and Ritchey 1.1 Crossbites, it's the fastest commute bike in town. For some people it's their mountain bike; for others it's their road bike; some buy it for loaded, long-haul touring far from the nearest repair station; some get it for city commuting. No matter how many bikes you own, this is the one you'll ride most often, because it's so fun to ride and so good at everything.

Like our other models, the head tube on the All-Rounder is 15mm longer than normal, so you can raise the bars that much higher. And it has a 15mm longer steer tube, too—so if you're between a 55.5 and a 58, you can probably go with the smaller size without suffering from having bars that are too low.

We often have people send in a frame deposit, undecided on either a Road Standard, LongLow, or an All-Rounder. The best way to decide is to consider brakes and tire size: The road frame is designed for sidepull brakes and accepts tires that are fat by road bike standards (up to 700x35, or 700x32 with fenders); the LongLow fits up to 700x38, or 700x35 with fenders; the All-Rounder is for cantilevers, and fits fat mountain bike tires, as well (up to 26x2.1 inches, or 1.9 inches with fenders). They all ride like good road bikes on the road; but the All-Rounder with fat tires is the most forgiving off road.

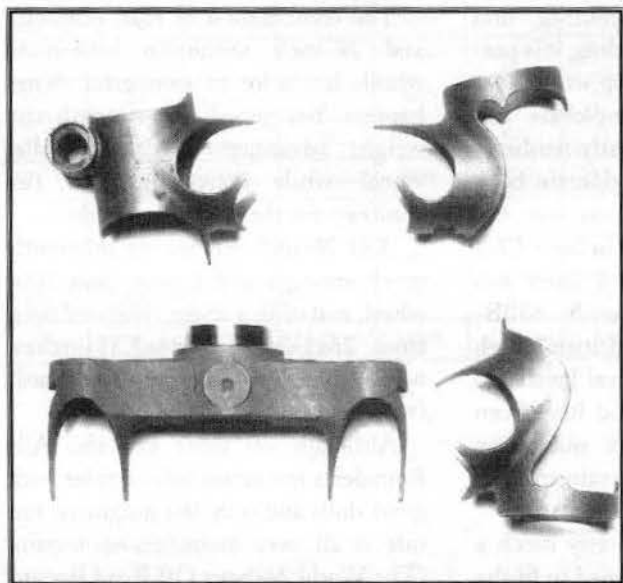

The lugs for the All-Rounder, the Mountain, and the 62cm and larger road frames are pretty and braze up quickly into stress-free joints. The crown shown is for our All-Rounder and Mountain frames. It is 56mm wide between the blades and fits tires up to 2.35-inches. Due to wider blade separation, we eliminated the windows in favor of a hollow box design, for added stiffness. With waists and epaulets.

Frame Sizing and Bike Set-Up For Comfort

The trend for the past ten years has been to get frames, especially road frames, too small. It may have come from BMX or mountain bikes, or from racers who didn't want to look like high-bar tourists. Whatever the origin, it's bad.

But the too-small bike phenomenon gets reinforced so often in bike catalogues and magazines, where we see studio shots of bikes, with high saddles and low, low bars, looking like mean, sneering panthers ready to pounce. Few people can ride such a bike comfortably. Those photos send the wrong message.

A key to comfort is getting the tops of the bars level or almost level with the top of the saddle, but so many things about the way bikes are designed and sized and sold conspire against that.

And you can't just raise the stem, because most quills are too short. Up-stems (rising extensions) would be fine (if slightly unattractive), but it's hard to find them with road-normal 26mm clamps.

There are ways around the problem, and there are stems out there (and in here) that'll relieve your pain, but it's frustrating that today's

norm is so wacky to begin with.

But this is our catalogue, and we want you to get the right size Rivendell, right off the bat. So—if you don't know exactly the size you want, and if you are willing to let us help you get the bike we think will be most comfortable for you, we need to know, at the very least, three things:

A. *Your overall height.*

B. *The height of your pubic bone.* Place your bare or stocking feet twelve inches apart and push the tape up past the nasty stuff, all the way to the bone. You'll need a helper.

C. *Saddle height.*

From the center of the bottom bracket to the top of the saddle. Your leg should be bent slightly, maybe 10 degrees, at maximum extension, and you shouldn't

have to tilt your hips to reach the pedals. Rules of thumb have a habit of being misconstrued as immutable laws, so be careful with this one: There should be roughly 10cm difference between your pubic bone height and saddle height. Probably 95 percent of the riders have a saddle height and pubic bone height difference of between 9cm and 11cm, so if yours is less or more than that, re-measure or re-adjust something.

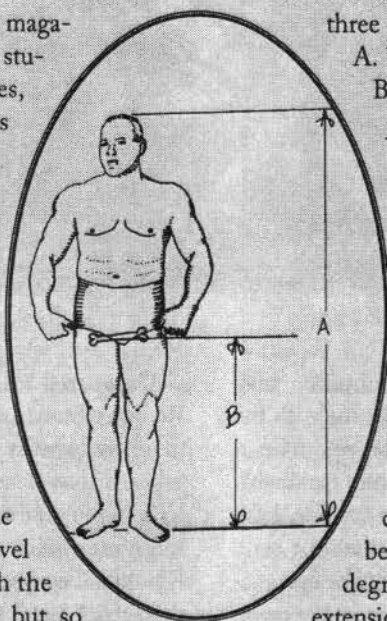

Rivendell Mountain/Expedition Frame



Rivendell mountain bike frames are designed with the idea that once you have a good position on a reasonable frame equipped with high volume, low-pressure knobby tires, it's time for skill, strength, and judgement to take over.

Stiff-armed riders cannot be made comfortable by modern suspension; just less uncomfortable. But when you learn to use your own joints as shock absorbers, you'll ride in comfort and as fast as you like over all kinds of terrain.

With that in mind, our mountain frame has no linkages, bumpers, springs, oil, maintenance requirements or need of aftermarket upgrade kits. It is lugged and silver brazed and made of heat treated Reynolds 753 steel, the same as all our frames; and we designed it for riders who are comfortable on road bikes and want to maintain a familiar, road-like position on their mountain bikes.

Compared to our road and All-Rounder frames, the mountain frame is more trailworthy because it has stouter tubes to handle more abusive surfaces. When you ride over bumps, it is more forgiving than a road bike or All-Rounder because it has (1) a slacker-than-road head tube angle and more steering stability for better control over those surfaces; (2) a higher bottom bracket for more pedal and chainwheel clearance; (3) a longer front-center (distance between the bottom bracket and the front hub), so you're not as likely to pitch over when you hit a bump on a steep descent; and (4) clearance for tires as fat as 26 x 2.35 inches (as does the All-Rounder).

The Rivendell mountain frame doesn't even look like a mountain bike frame. It's pretty, it's simple, there's almost nothing to it. If you see it without components, there's nothing to distinguish it

from a road touring bike or our own All-Rounder; and built up, the the only mountain bike-like feature likely to give it away is the wheels.

One key feature is the top tube, which we've sloped up and sized so you can achieve a good trail-riding position while using a standard road bike stem with either drop bars or Moustache handlebars. By "good trail-riding position," we mean one with the handlebars high enough so that you don't have to lean over too far to reach them. Your position is more upright than it is on a typical road bike. That takes weight off your hands and arms, making it easy and natural to relax your upper body so it can absorb shocks. When you have the right size you'll find yourself climbing short steep hills down on the drops. It sounds awkward, but feels natural, and is an effective way to muscle up a short, steep climb. Try to get the top of the handlebars level with or certainly within 3cm of the top of the saddle, then adjust to suit.

Less noticeable than the sloping top tube is the frame's shallower than normal seat tube angle. Most mountain bike frames have 73° to 74° seat tubes; ours are a degree or two shallower. It's not much, but allows you to achieve a nice rearward position without having to shove the saddle all the way back. You can shove the saddle all the way back on a road bike without any bad things happening, but it's a worse idea on a mountain bike, since you end up bouncing more on the saddle, and if the saddle is all the way back, the clamp is stressed more.

Rivendell mountain bike frames have steeper head tubes than commercial mountain bikes. On road bikes, steep head tubes are usually associated with smooth-road criterium bikes, so it may

seem odd that we purposely designed a 72.5-degree head tube angle—a degree and a half steeper than the industry norm—on a frame that we have not designed for racers or a gonzo riding style. But different things are going on on a mountain bike. A mountain bike needs a longer front-center than a road bike, and the longer front-center slows steering. So does a fatter tire with its larger footprint. We steepen the head tube slightly to compensate for the slow-steering effect of the fat tire and the longer front-center.

Next, the drop is greater than it is on most non-suspended mountain frames, by 5mm, which means that with any given tire, your Rivendell will have a bottom bracket height 5mm lower. (Modern, suspended mountain frames have much higher bottom brackets, to account for the compression.)

Typical mountain bike suspension forks are 405mm to 420mm long. They have to be that long because they shorten as they compress. But when you mount a typical modern "low profile" cantilever brake on such a long fork, the straddle cable is so low that the center wire has to reach down well below the crown, which means you can't mount a fender—the part that usually sticks out ahead of the fork crown area will run smack into the center wire. Racers don't wear fenders, so they don't care, but if your mountain bike is to fulfill the mountain bike promise of versatility, it ought to accept fenders. In any case, since most mountain bikes don't accept real fenders, there has been a proliferation of inelegant aftermarket splash-guard-style things that attached with Velcro or molded clips to the seatstays or downtube. They don't provide nearly the coverage of full fenders, and give the bicycles even more of a moto-cross

look—not that there's anything wrong with that, but it isn't our goal to make a bike that comes as close to being a motorcycle as it can, while still, technically, being a bicycle. (We are not anti-motorcycle! But bikes are different.)

The Rivendell mountain bike accepts full, real fenders because the fork crown allows us to design shorter blades (376mm), and the shorter blades allow the fender, the center wire, the low-profile brake adjustment—to be where they have to be, and everything works. Is it “suspension compatible”? Sure. If you put on a RockShox Judy, you'll slacken the head tube to about 71-degrees. The bottom bracket will rise as well, but we already start with something lower than usual, so that's okay, too.

Another thing to consider is whether you'd be getting the best of both worlds—a beautiful lugged steel frame with a plush fork—or whether you'd be dressing a pretty and wholesome farm girl in a dog collar, a rubber suit, black lipstick, and a spiked chartreuse mohawk. (We're making a point, not a statement.)

Another useful feature is rack eyelets. They weigh a few grams, aren't that ugly, and come in handy when you want to mount a rack.

Most modern mountain bike forks have 1-1/8-inch steer tubes, but Rivendell steer tubes are the original one-inch size. The industry as a whole has adopted the larger size because it is easy to sell the concept of a rugged off-road bicycle needing a bigger, sturdier headset. But there's more to the story.

Larger headsets came about both as a way to differentiate brands in the emerging commodities market, and as a

way to prevent head tube ovalizing in soft, high-tensile steel head tubes. Despite what makes sense intuitively, headset durability is not as much of a problem on mountain bikes as it is on road bikes, because the fatter tires cushion the blows so much better! So we're back to “product differentiation,” which has marketing value only; and ovalization-prevention, which is more elegantly handled by stronger steels and reinforced lugs on the head tube, both features on Rivendells.

The frame is just one of many things which affects how comfortable the ride is, and it still doesn't make as much difference as the wheels, your technique, and position on the bike. But all things being equal, a frame that is light and not overly rigid seems more comfortable to ride than a heavier, stiffer one. Maybe it's because light bikes are more maneuverable, so you avoid more bumps, and maybe it's because the lighter front end is easier to lift over bumps, to soften the blow.

The Rivendell mountain frame is designed for riders who prefer a simple, high quality frame for a riding style that emphasizes rider skill and judgement over technological solutions to minimize bumps and maximize speed. It feels light and maneuverable beneath you, and handles great over rocks, bumps, loose dirt, broken branches, whatever's around the corner. If you already know how to ride off road, and you want less technology between you and the ground, and you're okay with the occasional dismount when things get really spooky, the Rivendell frame is ideal.

Options, Prices, How To Order

SHORT TOP TUBE

It's more common for women to need this than for men to, but don't conclude that you need the shorter top tube without speaking with us. How the top tube dimension affects reach to the handlebars is widely misunderstood. We covered that in Rivendell Reader #6, but we're happy to explain it to you on the phone.

S AND S COUPLING

For an extra \$400, we can build your frame with S and S couplings—machined stainless steel screw-apart devices that get brazed into the top tube in front of the seat lug, and on the lower part of the down tube above the bottom bracket.

CUSTOM SIZES

If, despite all our sizes and models and top-tube lengths you still need a custom size, we can do it for an extra \$215. **The frame will still be our design, with all the qualities, aesthetics and design values of any Rivendell.** We've delivered road frames as small as 40.5cm, as large as 69cm.

GRAPHICS, COLORS

We like quiet-looking bikes, so decal-ing is minimal, and we pick the ones that go best with your frame color. **THE 1997 COLORS ARE: LT. BLUE METALLIC, LT. GREEN METALLIC, LT. ROSE METALLIC, SILVER, BURNT ORANGE, NAVY METALLIC, CANDY GREEN, CANDY RED, AND TUSK.**

Call for a color photo or see our color frame brochure after August 15, 1997.

MEMBER PRICES AND HOW TO ORDER

Single color frame and fork: \$1,100
Different color head tube: \$100
Headset, installed: \$40
UPS ground freight to lower 48: \$35

If there isn't a frame order form in this catalogue, call (510) 933-7304 and we'll mail or fax you one immediately.

Once the form is filled out and we have a \$300 deposit, delivery takes from four to six weeks, during which time we'll correspond frequently by mail or phone. If you prefer a complete bike, we can deliver one using parts we carry or any others, starting at around \$2,000. Few cost more than \$2,400, and if you give us a budget, we'll get you the best bike you can buy.

LAYAWAY PLAN

It's easy, low-pressure, and it's worked for many people who prefer to chip away at the frame for up to a year. Just send \$100 and say you want to put a frame on layaway. Every time we get a payment, you'll get a receipt showing the balance. Eventually you'll have to fill out and sign a frame order form like everyone else, and you should do that about 6 weeks before you want to receive your frame. When your frame is ready and paid off, we ship it. If you want to cancel at any time, we send you a full refund. Unless you've already had your name painted on the frame (that's an option), in which case we keep \$200 to cover the cost of repainting it.

Metal, Tubes, Lugs, Crowns

Most high quality steel bicycle tubing is chrome molybdenum (CrMo). Reynolds 531 is manganese-molybdenum steel, another great material, differing only by trace amounts of alloying elements. Rivendell frames are made of Reynolds 753, which is just heat-treated 531. The heat treatment dramatically increases its yield strength and tensile strength without hurting its elongation.

Yield strength, tensile strength, and elongation can be determined by pulling apart a two-inch solid bar of metal, as in a tug-o'-war.

YIELD STRENGTH is the amount of force required to stretch it to the point where it doesn't spring back to its original two-inch length. Paper clip steel has low yield strength; spring steel has high yield strength.

TENSILE STRENGTH is the force required to pull apart the solid bar of metal until it breaks in half. Cheese has low tensile strength; latex rubber has high tensile strength.

ELONGATION is the amount the bar stretched, relative to its original length, at the time it broke in half (when its tensile strength was exceeded). If the stretched piece measures three inches, the elongation is 50 percent, because the one-inch difference is 50 percent of the original length of two inches. Materials with low elongation: glass, ceramic, sunbaked plastic—brittle things. Cool, hard cheese has little elongation. Grilled cheese has lots. (Don't imply, though, that on warm days your frame is less brittle)

Frames aren't solid and they aren't

stressed that way exactly, but there are similarities. For instance, bending is like stretching. So knowing a material's characteristics is a good starting point, at least. In most materials, the higher the tensile strength, the lower the elongation (the more brittle it is), and that's not good, either. Plate glass, for example, has a tensile strength of 500,000 psi—five times that of CrMo. But it doesn't fail in tension, it fails because it isn't tough—it cracks easily, and cracks just zip right through it.

Another issue is fabricability. For a metal to be suitable for bicycle frames, you've got to be able to build a frame without changing the material's yield strength, tensile strength, and elongation too much. Once you've eliminated the unacceptable materials, the key is a good design, and maintaining the inherent properties of the materials throughout the building process—that's where skill with the torch comes in, and it's why you can't lump all frames of a given material together. No less an authority than frame builder Richard Sachs has said, "In bike-making, material is the least consequential thing on the planet." An exaggeration, but it makes a good point. Don't buy a frame for its material.

That said, Reynolds 753 is a wonderful frame material. Its flex characteristics are ideal, it resists cracking, and if a crack does develop in it, it will grow slowly and offer plenty of warning. These qualities allow a builder to design in a certain amount of flex, so the bike feels alive and essential. Admittedly, "alive" and "essential" are

CATALOGUE & PRICE LIST

unquantifiable terms, but a certain amount of springiness feels good.

LUGS, AESTHETICS, SENTIMENTALITY,
TRADITION, STRENGTH, OPINION, STRESS
DISTRIBUTION, HEAT, AND THE HOBO

I like frames that look plain from a distance, and reveal their fanciness only upon closer inspection. The tubes should be round and nondescript, and the joints, since they suffer the most, should look interesting, attractive, smart, maybe even unique.

I also like the idea of a fine frame being identifiable by brand, even without its paint, decals, and head badge, if it happens to wind up in a junkyard 100 years from now. In the case of Rivendells, I like to think that in 2097, a hobo art connoisseur could saunter by, see the frame, pick it up, see the joints, and say "Jiminy Christmas!—an old Rivendell ..." It's not a quest for immortality; I just think there should be something there that can't be sandblasted off. That's one reason Rivendells have lugs.

Rivendell frames are designed with traditional values, and lugs are part of that. Brazed, lugged bicycle frames have a unique, individualistic beauty, and are drop-dead practical to boot. Since brazing does not melt the tube, the tube's inherent qualities—the things you chose that tube for in the first place—are less disturbed, and individual tubes, if damaged, can be replaced. A skilled builder can make the rebuilt frame between 95 and 110 percent as good as new, depending on how good the joint was in the first place. A TIG-welded frame in need of a tube replacement is a scrapped frame. The tube beneath-the-TIG weld has already been irreparably altered, and can't take the high heat twice.

Until the mid-'80s even cheap bikes were lugged, and those deep-socketed, straight-cut lugs inspired, if not a second glance, at least a certain confidence. But in the past 15 years, the push for flexibility in designs and lower costs has pushed even the most revered Italian and American names to TIG welding, and now lugs on new bicycle frames are as scarce as arrowheads in a Yosemite campground.

Of all the popular frame building methods, silver brazing with lugs takes place at the lowest temperature: 1200°F, compared to 1600°F for fillet brazing or lugs with brass; and over 2200°F for TIG welding. There are some recent exceptions, but in most cases, and certainly with Reynolds 753, a lower flame is better for the tube.

Lugs play a structural role, too. When you think of them as external butting applied with relatively low heat, it's easier to see another function. Lug design is critical. A poorly designed lug takes too much time to heat, and concentrates stress in areas that cannot handle it. A well-designed lug supports the joint and distributes stress, and all the Rivendell lugs were designed with this in mind.

AIN'T LUGS HEAVY?

A Rivendell lug weighs within a few grams of an ounce, a bargain when you consider all it does for the joint in terms of tubing compatibility, strength, repairability, and pure aesthetics. Besides, the lug allows low-temperature brazing, which in turn allows you to use thinner tube butts, because the lugs themselves serve as external butting. For instance, the tube ends (butts) on most TIG welded frame tubing are 1.0mm, and even the best TIG welder is reluctant to go below 0.8mm.

A skilled silver brazer can easily handle 0.7mm or even 0.6mm butts.

RIVENDELL LUGS: HISTORY & TRIVIA

Rivendell lugs are designed to form strong, stress-free joints, to braze up quickly to protect the tube from excess heat, and to look as pretty as possible.

The design for the road lugs came about when I used to work at Bridgestone, and wanted the lugs on our '95 RB-1 to have elements of certain older style French lugs (Nervex and Prugnat). So I supplied Richard Sachs with blank lugs, which he then carved and filed by hand into these really pretty shapes. Bridgestone is history now, but our Road lugs were cast according to Richard's originals. He offers modified Rivendell lugs on his own frames, and since he designed them, he is the only builder we offer them to. Richard is not our competition; he is a friend and inspiration. (860 526-2059)

We collaborated with Waterford's Chris Fiorini and Marc Muller on the Mountain and All-Rounder lugs. They aren't as fancy as the road lugs, but they have their own swoops and curves and points, and we like them just as much.

FRAME WEIGHT, WALL THICKNESS, BUTTING, TUBE DIAMETERS, DENT RESISTANCE, FRAME WEIGHT, AND FRAME LIFE

Rivendell frames are light, but not eye-poppingly so. Most of the tubes were drawn to my specifications, and the goal wasn't to compete with thin-walled aluminum, butted titanium, or the new paper thin supersteels. When you design with weight in mind, it's tempting to trim where you shouldn't. If you use good materials in the right places and proportions, the weight will be appropriate by definition. I

wanted a light, beautiful, well-designed frame that's built to ride hard for many years without worrying about dents, fatigue, or buckled tubes, even if accidentally abused.

A 56cm Rivendell road frame weighs a bit over four pounds and satisfies all those requirements. The lightest aluminum and carbon fiber road frames weigh a bit under three. Good, safe parts required to make a frame into a rideable bike will add at least 17 pounds, and a well-fed rider can bring the weight up to 220. Even if you weigh just 118 lb, the decrease in combined rider and bike weight between a featherweight frame and one of ours is less than one percent. The extra material in a Rivendell is well-placed: Longer downtube butts to protect the frame's most vulnerable spot; slightly thicker downtube bellies to resist twisting; an extra 0.1mm in the chainstays to protect against fatigue and chain gouges.

During the past century, steel frame tubing dimensions have been tested over millions of miles by hundreds of thousands of riders, and the tube dimensions that stand up over the years are somewhat thicker than the tube dimensions currently in fashion. True, there have been advances in metallurgy, but it's equally true that if the steel marketers didn't feel pressured to compete in weight with aluminum (at one third steel's density) and titanium (at half), there'd be a lot fewer broken steel frames out there. Our tube thicknesses generally fall between standard Reynolds 753 and Reynolds 531.

A tube's diameter to wall-thickness ratio bears watching. Over the years, traditional steel tubing hasn't exceeded 50:1 ($28.6/0.6=47.66$), but most of today's supersteels have higher yield

🔗 CATALOGUE & PRICE LIST 🔗

strengths, and can exceed that by a certain amount. Oversized tubes with thin walls are stiffer and stronger, but a smaller diameter tube with a thicker wall resists dents better. High diameter-to-wall thickness ratios are especially suspect in aluminum, yet they exist.

The most highly stressed portion of a bike is the downtube, and the most abuse a frame can suffer is to run head on into a brick wall, or nature's equivalent. So against today's trend, our downtubes have substantial, full-length butts (100mm on the road frames, and 120mm on both the Mountain and All-Rounder frames. Downtubes are stressed in torsion (twisted) when you pedal hard, so we've kept the bellies thicker, so they twist less. (Waterford does this, too—and now is a good time to mention that we've relied heavily on Waterford's experience with all brands of frame materials. Marc still thinks we're too conservative, and he may be right.) We're not saying you can pile into a wall at 20 mph and not expect any damage, but Rivendell frames will survive certain abuses that would destroy many other frames.

A NOTE ABOUT BUILDING WITH REYNOLDS 753 TUBING

Most thin walled, heat-treated steels like 753 are more sensitive to heat than standard chrome-moly or Reynolds 531—even if the sales literature doesn't mention this. Since Reynolds doesn't want the reputation of this wonderful steel to suffer at the torch of a less than premium builder, it requires that frame builders pass a test in order to become certified. 753-hopefuls can buy from Reynolds a small kit consisting of a bottom brack-

et and four tubes, which they braze up and send to Reynolds for testing. But since 753 is so expensive, and must be brazed with silver (at \$7 per ounce, compared to brass, at \$6 per pound) most builders just opt for unrestricted tubing. Some of the best builders in the world are not 753 certified, but passing the certification test requires much better than average technique. Until recently the test was Pass/Fail. When Waterford submitted its samples (from seven builders, at the time), the scores were so consistently high that from that point on, Reynolds started giving Pass-A and Pass-B scores. It's doubtful anybody has more expertise with 753 than Waterford.

ABOUT REYNOLDS 853

This is Reynolds's new high-strength steel, and its tensile and yield strength scores beat even 753's. But it exists not due to any deficiency in 753. Reynolds wanted a supersteel that was TIG-weldable, and 853, since it thrives on heat, is it. Chasing higher metallurgical numbers is a neverending challenge, and beyond a certain point it's a mistake to think that stronger steels make a better frame. Almost all frame failures, at least in today's decent frames, can be traced to poor design, too much heat, or accidents.

Once your material is good enough, it's design and execution that separate good frames from bad ones, and durable frames from weak ones.

⊕ RIVENDELL BICYCLE WORKS ⊕



The underside of the lower head lug is critical on any lugged frame. All our lugs have have a large, spoonlike radius here, to distributes stress and eliminates the common "can-opener" fatigue failure one often sees in well-ridden lugged frames.

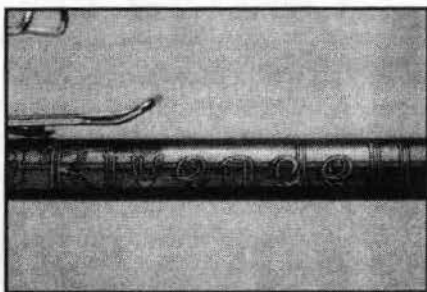

One version of our downtube decal. Different model and color combinations get their own decal, but the style shown here is typical, and they all look good.

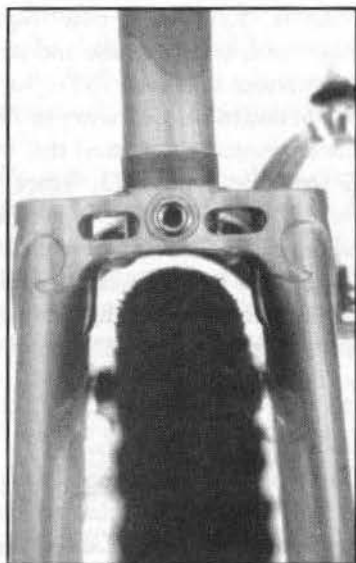

A rear view of our Road Standard fork, showing ample clearance, even with a Continental 700x35 knobby, with an overall diameter of almost 700mm. You don't need to ride a fatty like this to take advantage of the clearance, though. The clearance lets you ride fenders with tires up to 700x32 (depending on the tires, fenders, and mounting system). Equally nice clearance at the chainstays allows the tire to clear the stays even if you break a spoke.

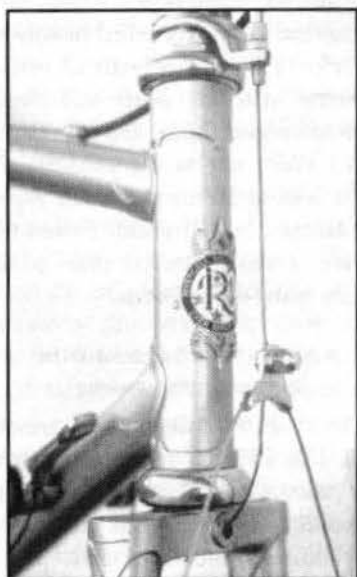

Our enameled nameplate is so fancy it even made Sports Illustrated (the Nameplate issue). As is the case with our downtube decals, we have several variations, they all look pretty much like this one, and we choose the one that looks best with your frame. They're screwed to the head tube by our own Gary Boulanger. First he drills a hole, then he taps it, then the screws...it's a pain, but the holes in the ears are too small for even the smallest self-tapping screws. We may switch to epoxy.

∞ CATALOGUE & PRICE LIST ∞

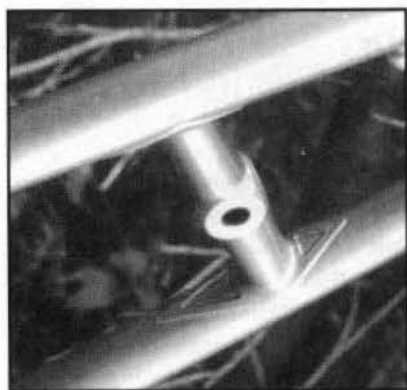

The seat-stay bridges have fancy tangs. In the old days these were considered reinforcements, but since there have been no known failures at seat stay bridges ever, we just do them because they're pretty.



For \$25 per application you can have your name painted on the frame. It can go on the left or right side of the top tube, back by the seat post or behind the stem; or on the left chainstay behind the bottom bracket.

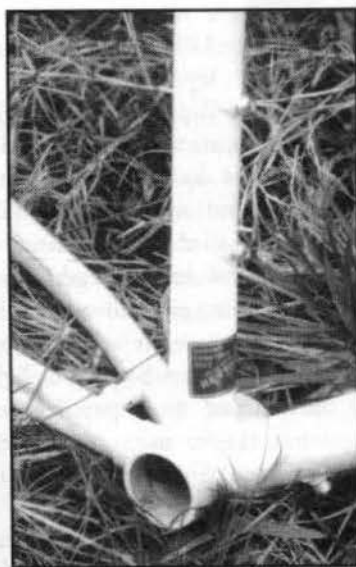

The All-Rounder and Mountain frames have a third set of bottle braze-ons underneath the downtube, and all frames have the Reynolds sticker at the bottom of the seat tube.



If you get a frame with a different colored head tube, you also get a matching diamond-shaped decal on the seat tube. Also shown: We lop the tops off the points of the seat-tube bottle stars, so they don't interfere with placement of the front derailleur. This isn't a sign of genius or an example of extra caring—to leave them on would be foolish!

Baggage

Most soft luggage and packs are made from 6 to 7oz nylon pack cloth or 11.5oz Cordura nylon. Nylon is cheap to buy, easy to sew, and has been sold on its tear strength and abrasion resistance, which isn't so honest. High tear strength and abrasion resistance are desirable, but most nylon pack fail at the seams. Go where folks with nylon packs gather and you'll see a fraying one before you or your friends can say "Jack Sprat."

Another problem with nylon is that prolonged exposure to sunlight kills it. Rock climbers see 4,000 lb test nylon webbing, after prolonged exposure, weakened to the point where it breaks with a strong pull by hands alone. At high altitude, continuous sun can turn a lightweight nylon tent into rice paper in sixty days.

We much prefer heavy cotton duck. It can bake in the sun with little damage, and if it starts to fray, it gets fuzzy fast, and the fuzzy edges prevent additional fiber separation (fraying) in much the same way that tangled or dreadlocked hair is hard to comb. That's why you can cut off your blue-jeans and wear them unhemmed. You couldn't do that with Cordura or Ballistics cloth nylon.

Cotton lacks nylon's abrasion resistance and tear strength, but a tight

weave of heavy cotton duck is plenty strong in both regards and a pack made of it will outlast a nylon one three times over. Hemp is even stronger than cotton, but it's expensive to buy, and we've yet to see hemp with the fine, dense weave of a high quality cotton duck. (Besides, we aren't sure if hemp frays and holds on as cotton does. Some-time we'll find out, but it may take a year or two.) Anyway, the only intriguing hemp fabric we've seen required a minimum order of \$100,000, and rich hippies we're not.

Zippers, especially nylon coil ones, are another weak point in any pack. No doubt some are better than others, but time and use kills them all. The coil abrades the inside of the slider, the slider itself gets bent, and the next thing you know your self-repairing coil zipper is self-opening, too, and it never gets better. For light use, the amount most panniers are subject too, they're okay. And sliders can be replaced! Still, for hard continuous use, and whenever security is more important than one-click convenience or instant access, we like the metal prong buckles on the Carradice bags.

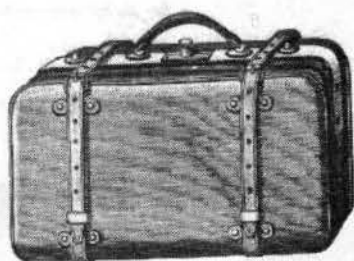

—Grant

Carradice Cycle Bags, From England

Carradice bags (rhymes with *paradise snags*) are made in England with designs, fabrics, and methods that have proven reliable since 1932. The fabric is 14oz waxed cotton duck (heavier than Filson tin cloth, even), the straps are thick leather, and the buckles are zinc-plated steel. These are exceptional bags built to last twenty years when used every day.

Between 1929 and 1952 virtually every saddle in England wore a saddlebag, and Carradice was the brand of choice. They are the traditional "transverse" style, which means they stick out, catch the wind, sway a bit, and gently massage your legs on the backstroke. They require some method of attachment to the saddle, such as the loops built into some Brooks models, or an adapter. We've been working on and hoping for and looking for a dandy adapter for 3 years now, and maybe this year something good will happen. Saddlebags are the best way to carry medium sized loads, and with enough lashing straps and creativity, you can carry bulky, unwieldy, oddly shaped loads that won't even begin to fit in the bag proper.

SMALL WARNING

If you're used to packs and luggage made with scientific fabrics and plastic one-hand quick release buckles, and mesh outer bags for drying your wet sox, the look of a

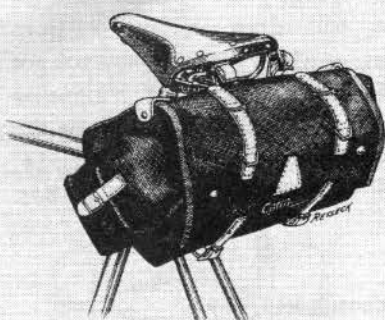

spanking new Carradice bag will make you feel uncomfortable. The fabric is starchy and black, loud to the scratch, and the thick, stiff leather is an unappealing white that makes you wonder why they didn't make them grey, at least. There's nothing stressed or acid-washed or pre-softened about Carradice bags—they actually need breaking in, because the leather straps are so stiff and the prong holes are too tight at first. It takes forty days of years of regular use for these bags to break in, and about five years of hard use before even a mother would call them photogenic.

Carradice bags don't have the features required to fill up the charts and win the magazine cyclebag shootouts, Consumer Reports would probably hate them, and they aren't for stylists. Still, for keeping your gear dry and secure, and standing up to the hardest use for the next couple of decades, they're as good as any, maybe better.



LOWSADDLE LONGFLAP:

A hobbit-sized version of the Nelson Longflap, but still huge by most standards, and a serious load carrier by any. Its capacity puts even the largest wedge packs to shame, and its style will draw comments from strangers, who'll wonder where you got it. Requires at least 10 1/2 inches between the saddle loops and the tire (unless you have a rack or fender). 14" x 9.5" x 7.5". 854 cubic inches. 11lb 8oz.

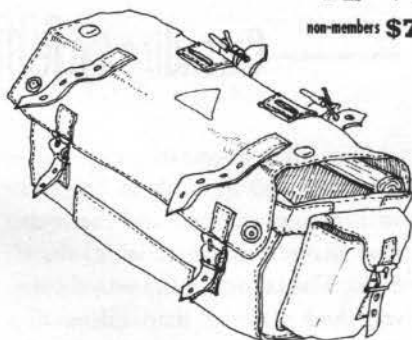

 **\$68**

non-members **\$75**

NELSON LONGFLAP

In ten years I've never had a day load I couldn't somehow fit into or onto mine (pictured). Lash points on the flap let you tie on a small bedroll or extra clothing, making this a fine bag for summer overnights, three-day hostel tours, or family day trips where you get to carry everything. Take along a long strap or a 3-foot cord and you can overfill the bag and still tie the flap down—I've done this many times with

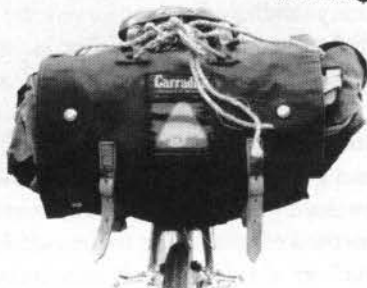

 **\$68**

non-members **\$75**

boxes and bags I otherwise could never have carried. One main pouch, two outside pockets. There's an orange reflective triangle on the flap to lessen your chances of getting smacked. 14" x 11" x 8". 1,098 cu. inches. Requires at least 12 inches between the saddle loops and the tire (unless you have a rack or fender).

11lb 10.72oz.

CAMPER LONGFLAP

How many Brooks B.17 saddles can you fit into your nylon wedgepack? We packed thirteen of them into Joe's Camper, and it didn't take fancy finagling. This is the cycle-camper's traditional favorite, hence the name, and if you can't fit in here, you're being too dainty. The side pockets are large enough for standard sized water bottle or a half liter Sigg fuel bottle. Needs at least 14 vertical inches between saddle loops and tire.

 **\$73**

non-members **\$79**

CATALOGUE & PRICE LIST

CARRADICE SUPER C FRONT (WORKS AS REAR, TOO)

11.5" tall x 10.5" wide x 5" deep, slightly tapered, and with an outside pocket big enough to hold, a first aid kit and two pair of sox. Each bag has one main pouch and a side pocket. Capacity: 1,464 cubic inches. 2lb 14oz/pair.



 **\$88**
non-members **\$98**

CARRADICE SUPER C REAR

Each bag has one main pouch and an outside pocket. 14.25" tall (unextended) x 12" w at the top, tapering to 8" wide at the bottom, and 7.5" deep. Don't get confused by the numbers—if you're after big bags, these are them, and since they're top loading, you can overstuff them to boot. Great heel clearance, even with huge feet. Capacity: 2,563 cubic inches. 3lb 6oz per pair.

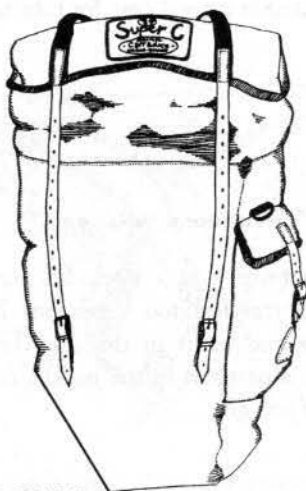

 **\$118**
non-members **\$125**

PRICING (IN GENERAL)

We offer fair values on everything we sell, but we don't want to become a haven for bargain scavengers. Our prices are low because we buy direct from the maker whenever possible, and we sell directly to you. We make good buys, but we don't use warrior negotiating tactics in the process, and in some cases, when the asking price was much lower than we could afford to pay, we paid more.

Most of our things are no longer made, and when they're gone the replacements will cost appropriately more. Especially the brakes. Brooks saddles, at \$65 each, are relative steals when you compare them to high-zoot plastic saddles. The price of the panniers you see on this page is less than that of most nylon brands, and not appreciably more than the cheapest house brands.

We try not to compete directly with independent bike dealers, and as you can see, most of what we sell, they don't. Support your local dealers—they provide many things we can't, including right-there service.

Wallets & Saddlebags



ACME WALLETS

These wallets not only tolerate disorganization, they're made for it. Three wide mouths are always open to swallow receipts, cash, cards, photographs, even coins, which go in the deep pocket, and when you need them, just tilt the wallet and let them slide to the lip, which is stiff enough to catch them. Made of Filson Tin cloth seconds, a 12oz waxed cotton that's been made the same way for a hundred years. Two sizes, each with three compartments. The checkbook model makes a good case for bike tools or small cameras.

ACME CHECKBOOK WALLET

About 6.5" x 11.5" open. It's pretty good for travelers, too. Capacious. Put receipts and coins in the deep back pocket, a passport in the middle one, and off you go.

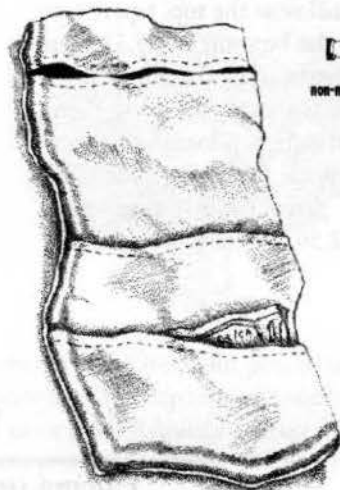

☞ \$16
non-members \$18

ACME NORMAL SIZE WALLET

Also holds checks, but folded. Fits in a back pocket. They're sewn inside out, and we get a better deal on them if we accept them that way. We could do that ourselves, but it takes about five minutes per wallet, and we charge a lot for the service, so you're better off doing it yourself. Use a round-end stick, a short broom handle, something like that. We've reduced the price a dollar from last year, when we delivered them ready to use.

☞ \$13
non-members \$15



ROUGHLY 3.75" x 9" OPEN.

CATALOGUE & PRICE LIST

ACME BIG BOY MUSETTE

This is called the Big Boy because we used to have a slightly smaller one. For carrying a few books and a binder, pencils and note paper, small camera and a banana, this one's perfect. There are two sets of loops. The lower one is for the waist strap, which we provide (cut the long strap in side the pouch in half). The upper loops are for you to attach your own, home-made shoulder strap to. A rope, a flat inner tube, webbing... 15" x 12" x 3". 290g.

 \$21
non-members \$24



ACME SADDLEBAG

Member Jack B. suggested we carry a smaller-than-Carradice saddlebag, so we had this one made to spec. It's pretty good and real simple: The main pouch is large enough to carry a long sleeve wool jersey and a Carradice rain jacket, and the two side pockets hold tools, tubes, patch kits, keys, money, small snack foods and a few emergency walnuts. The side pockets have loops you can tie together with recycled shoe strings if you like, but elasticized necks pretty much make that unnecessary except in the wettest Northumbrian squalls. The main pouch closes by means of a long strap which runs through a loop and ties to a seat stay. Made from Filson Tin Cloth seconds by a husband-and-wife team in Paradise, California.

 \$27
non-members \$30

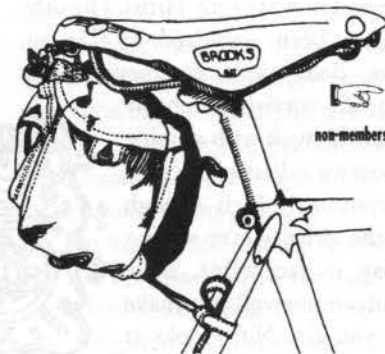

ACME TOOL AND TUBE TOTE

When all you need to carry is a spare tube and a couple tools, you can't beat this 16" x 16" cut of stout, finely woven unhemmed waxed cotton. Put your gear in one corner, roll it up until covered, then fold over the ends and finish rolling. Secure the wad with a stout rubber band or not, then strap it to your seat rails or seat stays with a toe strap; leather if you've got it (the buckle bites better). Always put one in a Carradice pocket, so when you get a flat you can just lay it out like a placemat, and your small stuff won't get lost in the roadside shuffle. Assorted, always stout fabric in some earthy tone, depending on availability.

 \$3
non-members \$4



Nitto of Tokyo

Nitto is flat-out my favorite bike parts maker. They're just unspoiled, unsullied, uneverything else that most modern, market-driven powerhouse and little companies that dream of largeness aren't. Twenty-two years ago there were twenty different manufacturers of bicycle handlebars and stems in Tokyo alone and now it's only Nitto. The others have been outpriced by Taiwan, China, Bangladesh, whomever, while Nitto has survived probably because it stuck with making the best regardless of price. If the volume is high enough and the price you're willing to pay is acceptable, most manufacturers will just make what you ask. Nitto looks at submitted designs or ideas and rejects the structurally stupid ones, and very politely suggests ingenious ways to make your part prettier and stronger and simpler at the same time. The Moustache Handlebar is a good example. I designed it first on an airplane ride, then had several prototypes made, in the U.S. and Taiwan. In fairness to the U.S. prototype, the guy who made it was used to bending copper plumbing pipe, which is what he made the bar out of, and it crumpled when I slipped on some rare black ice. The Taiwan bar had bad kinks and ugly curves. I sent my drawing (a crude one) to Nitto, with all the dimensions specified, and on my visit there in 1991 they presented me with the prettiest bar I'd ever seen. I barely recognized it.

Then when Bstone went down in

1993 and I was planning Rivendell (which at the time I was calling Ecovelo), I contacted a US handlebar maker to see if it could make the Moustache H'bar. I sent a blueprint and a sample, and a month later was told it would cost \$13,000 in tooling, and they still couldn't bend the 2014 T6 aluminum Nitto uses for the Moustache H'bar; and the sleeve was too hard, and the shape would have to be modified. Then he said "You know that bar you sent me? I had it on my desk on and off for a few weeks, and our guys here would pick it up and examine it and sort of drop their jaws and say 'wow—how do they do that?'" It looks simple enough to me, but there must be something tricky going on. Nitto is so well respected in



Japan that it helped write the industry's handlebars and stem testing standards. Over the years, and especially when the exchange rate was more favorable, Nitto has made parts for Tom Ritchey, Specialized, Wilderness Trail Bikes, and Scott. (A bar that to me looks identical to the Scott "Drop-In" bar appeared in an old (pre "Drop-In") Nitto catalogue as a Nitto original made for upside-down use on a stationary bicycle.)

Nitto makes stems, handlebars, racks, and various small parts out of metal. Nitto-built bicycle parts are smooth, shiny or satin-like, simple and strong, and before they're offered for sale, have been thoroughly tested to the strictest standards. Not market-driven; quality-driven!

—Grant

Handlebars

No bike part affects how you feel on the bike as much as the handlebars do. Well, maybe the saddle. But the point is, a change of bar can compensate for a stem that's too long, too short, too high, too low. It can change your weight distribution on the bike, affecting the way the bike handles and how relaxed you feel on it. A change of bars can make numb hands, numb genitals, or a sore bottom disappear or reappear.

WRIST POSITION AND HANDLEBAR SHAPE

When you let your arms hang down relaxed and naturally, your palms face inwards; and when you bring your arms forward, the palms still face inwards, so it's no coincidence that a palms-inward position works well on a bike, too.

The very first handlebars on those wooden bikes of 130 or so years ago had straight bars, because the great minds of the day were concentrating on things like drivetrains, not how to hold on. Eventually handlebars grew curves, and once the safety bicycle took over, the bars grew more curves and started sweeping back gracefully towards the rider. In time, and it didn't take much, shapes very much like our Moustache H'bar started appearing. The drop bar evolved out of the moustache-style.

Some of the early mountain bike people (Charlie Cunningham, Jacquie Phelan, Scot Nicol) rode drop bars early on, and many good riders still prefer them. If you're comfortable with

drops on the road, you'll like them off-road, too. You just have to get them high enough, and that's easy.

Flat/straight bars are easier to sell in the mass market, because many new riders feel assured by the grip position (which is a lot like hanging onto the bar on a roller coaster). They're given credence because pro racers use them for high-speed bumpy racing and descending, and a lot of people copy racers. Mountain bike brake levers and shifters and grips have been sized to fit this style bar, and that powerful sucker punch pretty much guaranteed that drop bars would never get a fair shake in the mainstream market.

"Bar-ends" don't fully compensate for the drawbacks of a flat bar. Most mountain bikes have long top tubes and long stems to compensate for the straight bars, and adding bar-ends to an already stretched out position puts your weight too far forward for climbing, and you lose rear wheel traction. They're not good for speed-riding, since they make it impossible to reach the brakes without taking your hands off the bar. A shorter stem matched with a bar that provides both a closer, wrist-in position and additional reach by means of a forward bend solves these problems.

If you like your straight bars, don't change. But since straight bars can be had almost anywhere, and since we personally don't find them good for general riding, we don't sell them.

Where To Put The Levers

RIDE YOUR BARS UNTAPED TO MAKE IT EASY TO
EXPERIMENT AND FIND WHAT WORKS FOR YOU.

1. FACTORY STANDARD

Level bar, level lever. With medium drop bars, it allows a decent on-the-hoods position, and easy access to the lever while on the drops. On a deep drop bar, lever access is good, but the lever body is too low for a good resting-on-the-hoods position. Excellent off-the-seat climbing, and sprinting while on the hoods. Production bikes come this way (easy to maintain consistency at the factory).

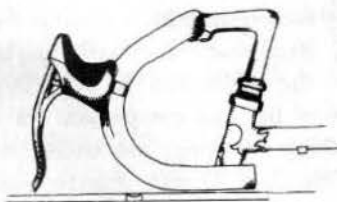

2. HIGH BELGIAN

(As allegedly espoused by Merckx and his countrymen.) Level bar, high lever. Hand/wrist position on-the-hoods is good, but as you raise the levers on the bar, the lower lever moves farther away from the curve—so you need biggish hands to reach it. Decent off-the-seat climbing and sprinting while on the hoods, but not as good as Factory Standard.

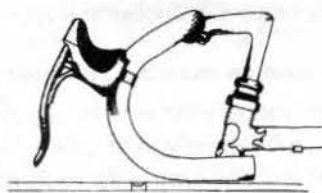

3. GOOD FOR EVERYTHING

High bar, low lever. Easy reach to the brake; with good hood-riding position. Notice how rotating the bar upward flattens out the slope just behind the hood, for more support. It also "opens up" a medium drop bar to accept a big fat hand. Decent off-the-seat climbing/sprinting on the hoods. This is my favorite position, but it may not work best for you.

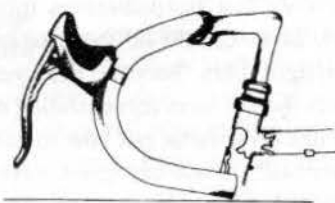

4. SMALL-HANDED PACK CHASER

Level bar, low lever. Lousy on-the-hoods position (levers too low), but shortens the reach to the lever—good if spend tons of time in the drops and have small hands. Otherwise, not very comfortable.

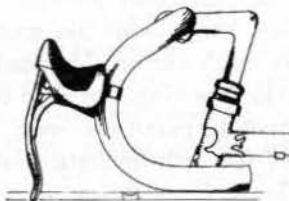

5. LONG-FINGERED KANSAS TOURIST

High bar, high lever. Excellent on-the-hoods and behind-the-hoods position, but the levers are too high for off-the-saddle riding, and kind of far out there for on-the-drops braking. Comfortable all-day riding position, but watch it at intersections.

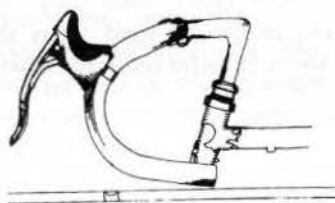

CATALOGUE & PRICE LIST

⑤ソーマー加工研削機

昭和 (1/1)

1
2
3

① フォーム
② 加工

① ② ③

マウンテンバイク用

株式会社 日東

1	2	3	4	5	6	7	8	9	10	11	12	13	14	15	16	17	18	19	20	21	22	23	24	25	26	27	28	29	30	31	32	33	34	35	36	37	38	39	40	41	42	43	44	45	46	47	48	49	50	51	52	53	54	55	56	57	58	59	60	61	62	63	64	65	66	67	68	69	70	71	72	73	74	75	76	77	78	79	80	81	82	83	84	85	86	87	88	89	90	91	92	93	94	95	96	97	98	99	100
1	2	3	4	5	6	7	8	9	10	11	12	13	14	15	16	17	18	19	20	21	22	23	24	25	26	27	28	29	30	31	32	33	34	35	36	37	38	39	40	41	42	43	44	45	46	47	48	49	50	51	52	53	54	55	56	57	58	59	60	61	62	63	64	65	66	67	68	69	70	71	72	73	74	75	76	77	78	79	80	81	82	83	84	85	86	87	88	89	90	91	92	93	94	95	96	97	98	99	100

Mod. 185-14 S

注1) 品質ハ「JIS D 9412自転車用ハンドル」
ノ各項目ヲ満足スルモノトスル
注2) 鋼管部ハ「JIS S 400」及ビ
メッキ鋼管ノ強度ハ順次見本ニシテ
注3) 表面処理：成形後、黒入れ
第1曲行直線部ニ「バフ」処理
アルマイト処理

NITTO MODEL 185

昭和 (1/1)

W
A
40
120
102
21
23
40
R73

22°
R54

1
2
3

① フォーム
② 加工

① ② ③

ドロップ

株式会社 日東

W	A	切断
370	207	91.5
380	217	92.5
390	227	93.5
400	237	94.5
410	247	95.5
420	257	96.5

1	2	3	4	5	6	7	8	9	10	11	12	13	14	15	16	17	18	19	20	21	22	23	24	25	26	27	28	29	30	31	32	33	34	35	36	37	38	39	40	41	42	43	44	45	46	47	48	49	50	51	52	53	54	55	56	57	58	59	60	61	62	63	64	65	66	67	68	69	70	71	72	73	74	75	76	77	78	79	80	81	82	83	84	85	86	87	88	89	90	91	92	93	94	95	96	97	98	99	100
1	2	3	4	5	6	7	8	9	10	11	12	13	14	15	16	17	18	19	20	21	22	23	24	25	26	27	28	29	30	31	32	33	34	35	36	37	38	39	40	41	42	43	44	45	46	47	48	49	50	51	52	53	54	55	56	57	58	59	60	61	62	63	64	65	66	67	68	69	70	71	72	73	74	75	76	77	78	79	80	81	82	83	84	85	86	87	88	89	90	91	92	93	94	95	96	97	98	99	100

Mod. 175

NITTO MODEL 175

W	A	切断
390	185	880
400	205	890
420	225	910
450	255	940

品1) 高規格 F210 200111 最新型用ハンドA9
 2) 高規格用鋼管スチールノーズ
 3) 鋼管製 ハブスリ(又はハブスリ)製
 4) 内外側ノーズ・鋼管製スチール
 5) 鋼管製、アルミ製

品名	ドロップバー
品番	RM-013-14S
メーカー	株式会社 日東
サイズ	1/2
単位	個

NITTO RANDONNEUR

W	A	B	切断
460	252	400	925
480	272	420	945
520	312	460	985

目寸法の測定方法
 Bは、バーエンドの位置で測定する。

品名	マウンテンバイク用
品番	RM-013-14S
メーカー	株式会社 日東
サイズ	1/2
単位	個

NITTO DIRTDROPS

CATALOGUE & PRICE LIST

ALL OUR DROP-BAR MODELS HAVE 26MM CLAMP CENTERS.
THE MOUSTACHE H'BAR COMES IN BOTH 26MM AND 25.4MM.

NITTO MODEL 185

Easily our most popular road drop bar, because it's just so nice. Almost identical to a Cinelli #64, if that means anything to you. If you've grown accustomed to deep drops, try these once and you may have a new favorite. They feel great.

Weight(42cm): 315g
Sizes available: 40-42-44cm

 **\$38**
non-members **\$45**

NITTO MODEL 175

This is the last pure, classic-in-every way road bar. Shaped a lot like the Merckx bend 3ttt, but without the cable grooves. Lots of flat roaming room. If you like deep drops, you'll like this one. It's not as deep as a Cinelli #66, but it's still deep.

Weight(42cm): 320g
Sizes available: 40-42-44cm

 **\$38**
non-members **\$45**

NITTO RANDONNEUR

Randonneur bars originated in France, and came as standard equipment on lots of the touring bikes sold here in the '70s. The upper portion is gently swaybacked, leading to little hand-supporting humps on the end. The drop is shallow, and the ends flare slightly. Ours are 42cm wide to the center of the curve, and 45cm wide at the ends. A nice bar, and some riders will ride no other. Notice the level section just behind where the brake lever goes—good hand support!

Weight: 325g
Sizes available: 45mm (end to end)

 **\$38**
non-members **\$45**

NITTO DIRTDROPS

Originally designed for Bridgestone's 1987 Drop-bar MB-1. A 7-degree flare increases wrist clearance, important for climbing hills in the drops, which you'll do a lot if you position these bars high enough for good all-around trail riding. The flare is subtle, so the brake levers stay verticale. The flare helps pulling, too. The medium width bar (about 42cm at the middle of the curve) comes in standard or heat-treated; the wide bar (3cm wider) is heat-treated only. For general use, we prefer the normal width; but if you're a large guy or want a great bar for steering around a tandem, the wide one is the best choice. Specify width. All models have a 26mm clamp area.

Weight: Road, 315g; Mtn
(heat-treated normal width), 430g

 **\$38 Road**
\$50 Mtn
non-members odd **\$5**

PRIEST HANDLEBAR

I think this is the prettiest and best-feeling three-speed-style bar out there. It's aluminum, reasonably light, and feels good to hold onto and ride. Most city-bound mountain bike riders would do well to convert their flat bars to this one, and all the fittings will swap right over. The bike will immediately look better, too. Clamp diameter is 25.4. It fits most mountain bike stems, but the only stem we have for it is the Nitto Technomic (not Technomic Deluxe).

Width: 54cm Weight: 340g

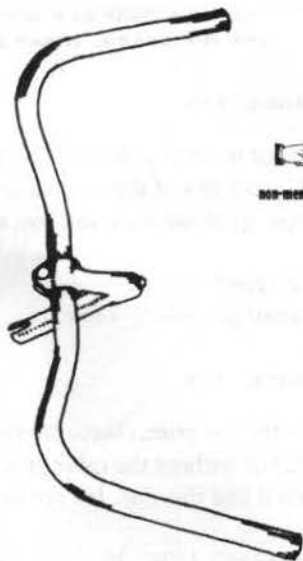

 **\$38**

non-members **\$45**

SUNTOUR XC LTD.

THUMB SHIFTERS

The original mountain bike style, but these were made in 1987 or 1988. Peter promises they index perfectly with Sachs 7-speed clusters ("better than a SunTour/SunTour combination!" he bellows), but they have a fake friction mode, too, that works with anything ever. Good with Priest bars. Mount the levers on the outside, so they move up and down. We don't have many left—twenty-five or twenty-six—so shop early.



 **\$29**

non-members **\$39**

Moustache Handlebars

MOUSTACHE HANDLEBAR...

A variation of a shape that has been around for more than a century. This specific bend was settled upon after at least five prototypes and thousands of miles of testing and refinement. It offers the quick and easy braking position of a flat bar with the multiple hand positions of a drop bar—and is better than either for a whole lot of riding. You can go fast on the road and get more aero than you can with a standard drop bar. The wider-than-a-drop bar grip lets you pull yourself up steep climbs and stay in control on bumpy sprints. You can ride the Moustache Handlebar off-road and access the brakes instantly, just as you can with a straight bar.

John Stamstad rode it to victory in two Iditabikes and two World Record 24-hour off-road rides, and still rides it on the road; and Gene Oberpriller won the Chequamegon Fat Tire race on it. We'd never credit the bars with

these accomplishments, but both riders rode them because they like them, and the bars clearly didn't hold them back.

We often hear from people who have switched to Moustache H'bars and found relief from back and neck pain. On a commute bike where speed, visibility, quick brake access, and mul-

multiple hand positions matter, there is no better bar. If you have an extra bike you don't ride a whole lot anymore, try some of these on it and that may change.

Available in 26mm and 25.4mm clamp diameters, but otherwise identical. The bar diameter is 23.8mm (road size), so it fits all road fittings and bar-end shifters. Does not fit thumb-shifters or normal mountainbikey stuff. Heat-treated 2014 T6 aluminum. Tip: Most people, switching from drops to Moustache H'bars, prefer a stem about 3cm to 4cm shorter.

Weight: 350g

Width: 51cm

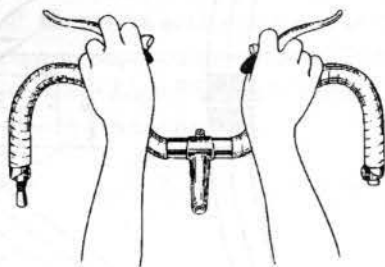

 **\$50**
non-members **\$55**

Mono-Links Handbars

SENT TO : Grant Petersen
FROM : NITTO JAPAN
A. YOSHIKAWA

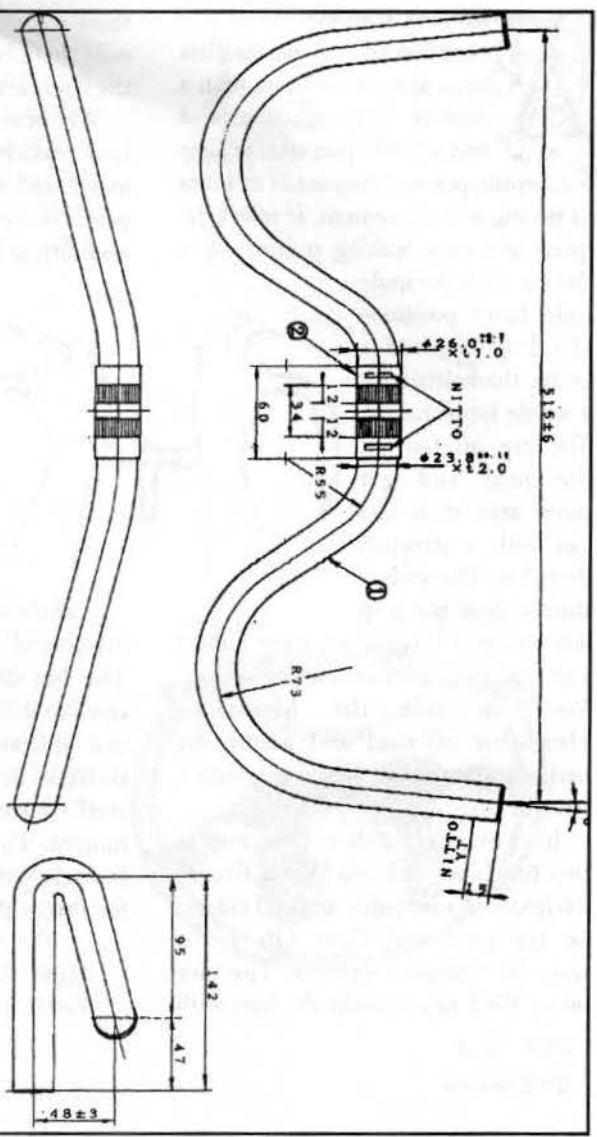

2	FERRULE	ALUMINIUM ALLOY	φ26.0x11.0
1	BAR	ALUMINIUM ALLOY	φ23.8x12.0
M S T A C H E B A R			
MODEL	R M - 0 1 6		
DR. BY	M. SADO	DATE	91. JUN
CHD. BY	A. Yoshikawa	SCALE	1/1
NITTO HANDLE WORKS CO., LTD			

CATALOGUE & PRICE LIST

TRESSOSTAR CLOTH BAR TAPE

Good grip, good looks, good feel, weighs just 35g per bike (2 rolls!), it's been around forever. It fades to nice colors, and if you ever get tired of it or wear it out, you can leave it on the bar as the perfect base for any other bar-wrap. Almost impossible to wrap well, but consider that part of your bicycle education. The trick, according to Marc Elliot, is to wiggle and stretch as

you go. For best results, position the lever clamp where you want it, then pre-wrap the clamp itself, and then wrap the whole bar sans lever body. A double-wrap of Tressostar feels real nice, but if you ever change bars, stems, or brake levers, it takes half an hour to get it off. PRICED PER ROLL, AND YOU NEED TWO PER BIKE. We try to keep all colors in stock, but our suppliers run out, too. *The best color selection in town:*

White • Black • Medium Blue • Light Blue • Red • Yellow • Tannish • Orange • Green (sort of a blue-green, but mostly green) • Brown

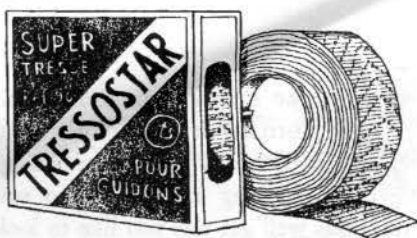

Two rolls per bike!

 **\$3 per roll**

non-members **\$4 per roll**

VELOX HANDLEBAR PLUGS

Back in the stone age before the gram cops took over the world, when downtube shifters were the norm, and Shimano was best known for its economically priced 5-speed freewheels, Velox handlebar plugs—the Taj Mahal of handlebar plugs—graced the ends of virtually every middle-to-high quality ten speed in Europe, and at least half of them in the United States. They still don't fit flush with the handlebar, they

still weigh 32.6g per pair, and we stock blue (sort of a clay-green blue), green (sort of a green green) and the black we all know and love. Those are the only colors we can get. We may run out of the greens, since we haven't actually seen them yet.



 **\$4**

non-members **\$5**

Goosenecks

The stem is your bike's hood ornament, and over the course of a ride you end up looking at it a lot, so you might as well get one you like to look at. If you can't afford to do that right now, at least tape a picture of somebody you like on it.

On road bikes, we prefer stem angles between 72 and 75 degrees, because when you look at them from the side, they're more or less parallel the top tube and seem to flow into the curve of the handlebar. It just looks right. Compared to a stem that shoots straight to the bar, these traditional designs invariably weigh more and must flex more, too, but weightwise it's only a few ounces, and flexwise, it just doesn't matter. Maybe if you're a 228lb guy racing the kilo on the track, but that's all. General, all-purpose hill climbing doesn't flex stems much at all. The next time you climb a hill of less than 22 percent grade, notice how you stand up and lean over the bars, but actually pull up on them very little.

There ought to be one and only one way to measure stem extensions, but there are two—the Normal Way and the Nitto Way; and as much as we love Nitto, its way drives us nuts. The Normal Way measures along the top, from the center of the hex-hole to the center of the clamp. The Nitto Way measures from the intersection of the centerlines of the quill and extension to the center of the clamp—which happens to be a point in space. A Nitto 8cm is about like a Cinelli 8.7; and so forth. Keep that in mind when ordering. Another thing to keep in mind is

that, as you raise the stem, the bars become easier to reach. So if you currently ride an Italian or other stem with a 135mm quill and (for example) a 10cm extension, and is two and a half inches below the bars, you can easily go to an 11 if you're switching to a Nitto Technomic Deluxe, with a 180mm quill. Assuming you want to raise the bars.

We have a better than average selection of long-quill stems with 26mm clamp, and probably a day doesn't go by when we don't sell at least two or three stems to riders who've tired of riding their bars too low and have finally decided to get them up. As we've said elsewhere in this catalogue, raising your handlebars an inch or two or sometimes three will do wonders for aching backs, sore-to-numb hands, and stiff necks. It's the single most comfort-increasing change you can make on your bicycle, falling ahead, even, of fatter tires.

In last year's catalogue we admitted a slight preference for stems that tighten with cones, over those that tighten with wedges; and the main reason was that the upper point of the wedge could lead to a broken steer tube if you raised the stem too high and that point ended up in the threaded portion of the steer tube. Then a customer from Australia pointed out a nifty way around that: Grind off the tip of the cone, maybe the top 4mm. The stem tightens as before, but no more nasty point! It's best just to not get the stem too high, but we like the clever and obvious solution, anyway.

Stems

NITTO PEARL

Cold-forged aluminum, beautiful satin finish—better than the old Cinellis, even—nose-in-the-win clamp bolt like the Cinelli 1/A, but with a wonderfully tall, 150mm quill, so you can get the bars nice and high. The clamp area is narrower than many stems, and it looks especially elegant. It can't be as stiff as the Nitto Aero on the next page, but it's stiff enough.

Nitto measures stems through the center of the extension, not the top, so an 11cm Nitto measures about 11.7cm the way most stems are measured. This stem has a 72° angle and a 150mm quill. Our favorite stem. The side of it has Pearl (and then the size) in some script-tyle letters. That's kind of weird, but we've gotten over it, almost. 8-9-10-11-12-13cm

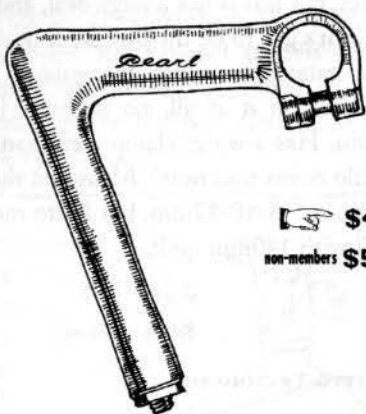

👉 \$45
non-members \$50

TECHNOMIC DELUXE

This stem is stylishly saving America's aching backs. The long 180mm quill lets you raise the bars 2+ inches higher than a standard 3ttt/Cinelli, and that makes the difference. Cold forged aluminum, very nice looking. Finish quality is slightly less than that of an old Cinelli, but easily good enough to put on any nice bike. 26mm clamp fits Nitto, Specialized, Modolo, old 3ttt, ITM. 7cm to 12cm.

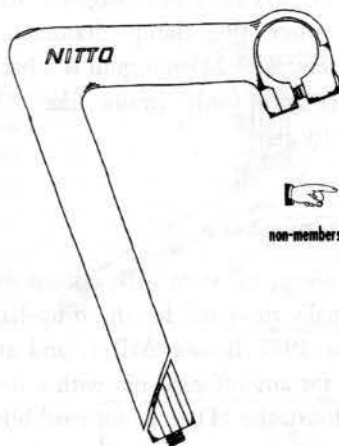

👉 \$32
non-members \$41

NITTO YOUNG III

Young III is a nice stem with a tall, 160mm quill and a 72-degree angle. It's gravity cast, so it's not as strong as a cold-forged stem, but still way better than pressure-casting. A nice looking stem on any bike, and a perfect low-cost retrofit. Limited supply, may be all gone after September. : 9-10-11-12cm.

👉 \$20
non-members \$23

NITTO AERO

These were made for Specialized back in the '80s. The 140mm quill on these is 10mm shorter than the Pearls, but still 5mm longer than a standard Italian cold forged stem. It tightens with a steel wedge. We prefer cones to wedges, and aluminum wedges to steel ones, but this is not a huge deal, and at \$17, it's got to be the best stem deal in the catalogue, if not the galaxy. No writing on it at all, no nothing, just plain. Has a wider clamp area than the Pearl so it ought to be marginally stiffer (Kilo riders take note). Measured the same as the other Pearl, so the 8cm is a long 8cm, etc 8-10-12mm, but Nitto measures along the side, so an 8 is a long 8, etc. All with 140mm quill.

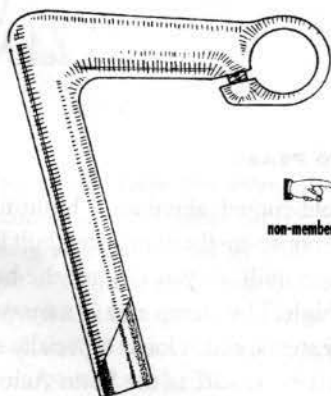

 **\$20**
non-members **\$29**

NITTO TECHNOMIC

When you want to sit upright and your bike won't allow it, put this stem in. You may have to change the bars, too, since the clamp diameter is 25.4mm. The 225mm quill is a back-saver. 9mm only (more like 9.7). Gravity cast.

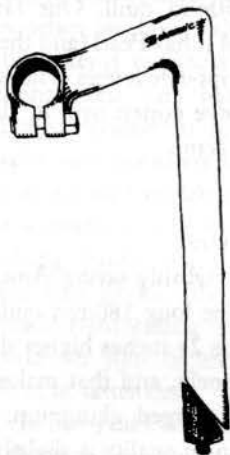

 **\$34**
non-members **\$45**

NITTO DIRTDROP

A short, tall stem with a steep rise, originally designed for the drop-handlebar 1987 Bstone MB-1, and still ideal for any off-road use with a drop or Moustache H'bar, or for road bikes when a higher and closer stem is the goal. Cold forged by Nitto from 2014 aluminum. Quill length: 160mm. Actual extension, 80mm; effective horizontal extension, 65mm. 335g. With or without cable hole. SPECIFY.

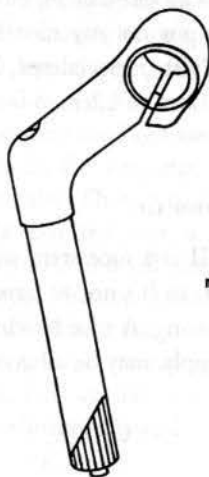

 **\$43**
non-members **\$49**

Front Derailleurs

A front derailleur has such a simple task that it's hard to make one that shifts poorly, and to date, nobody has.

Only four things matter in a front derailleur: (1) Fit. It's got to fit between the chainwheel and the crankarm of any crank you might want to use. (2) Weight. If it's more than

129g, it's too heavy. (3) Smart design. You should be able to identify the inner and outer adjusting screws. (4) Looks. Straight, simple cages look better than computer-designed ones. We sell only clamp-on, bottom-pull models (normal style). We're not aware of any advantages to top-pull models, so we don't stock them.

SUNTOUR ALPHA 5000 TRIPLE

A wonderful front derailleur for two or three chainrings. Designed for an 18t spread, but seems to work fine with at least 22t. All silver, no paint, visible adjustment screws so you know which screw affects inward travel and which affects outward travel. Best of all, the cage is narrow enough to work with high-quality, low-Q Factor cranks.

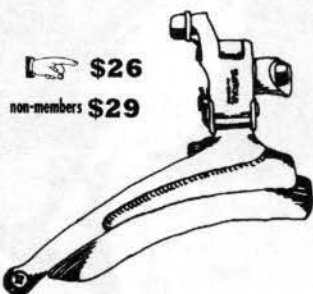

\$26
non-members **\$29**

SUNTOUR LITE, WITH SHIM!

By all rights this should cost \$22.95, but we got them for less than a dollar, and so \$7 it is. (Not all our margins are that great.) Sized for an inch and a quarter seat tube—an eighth of an inch fatter than Rivendell and most other steel frames use—so it comes with a clear rubbery shim, which, if you think about it, is a good ideal for all front derailleurs. Works great, and isn't out of place on any frame. The world's best deal on a front derailleur.

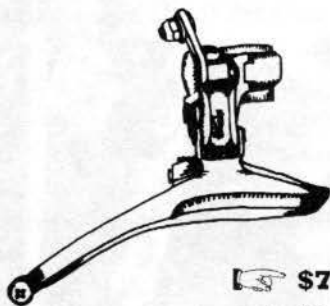

\$7
non-members **\$9**

SHIMANO DURA ACE

Shimano's top racing front from about 1977. Beautiful, Shimano at its best. Only 25 left.

\$35
non-members **\$40**

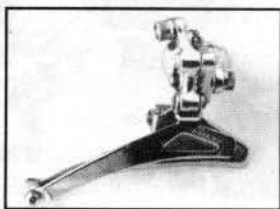

SIMPLEX B & B

Glaring, in-your-face proof that cheap front derailleurs work great. It's red and white and chrome, and half the clamp is plastic. But it's French, and \$5. Made for road doubles (two chainrings), but may work with some triples.

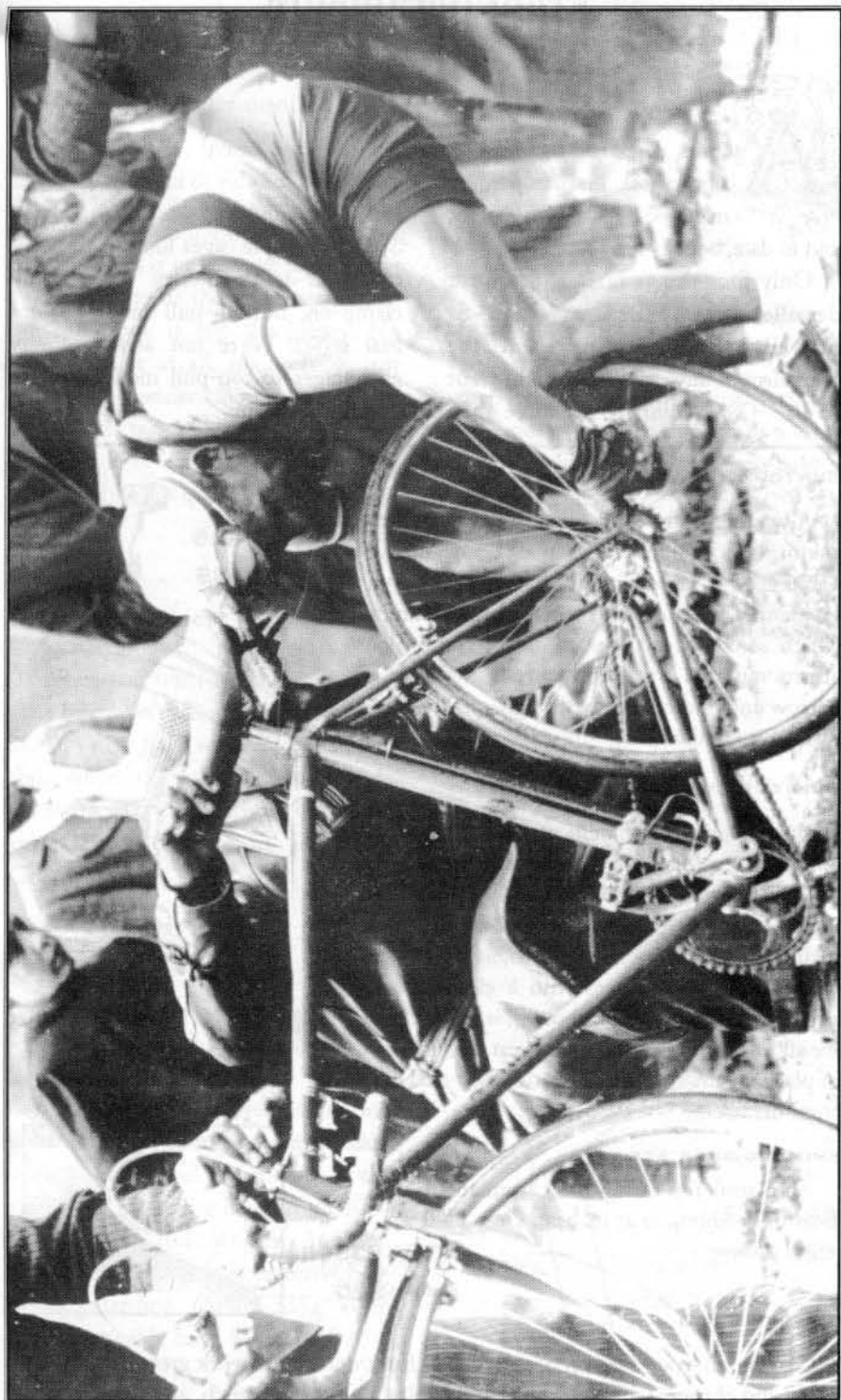

THIS COULD BE YOU.

Gear Shifting and Shifters



That burley chappy-man in the photo is changing his gears in the 1937 Tour de France. His bike has one cog on each side of the hub, so he has to dismount, loosen the wingnuts and flip the wheel over. Campagnolo's first rear derailleur came out a year or so later. It had two quick-release-looking levers on the right seat stay. One of the levers really was a hub quick release, and the other was a handle that guided the derailleur—in this case, a rectangular cage about half an inch wide and two inches long, which enclosed the chain. To shift gears you coasted, opened the quick-release to free the hub, then back-pedaled half a turn while guiding the chain with the other lever, all the while weighting the rear wheel to keep the chain from going slack. It required a special dropout and axle, and the whole procedure is harder than it sounds.

Ninety-eight percent of the currently manufactured road bike shifters don't require any shifting skill at all and are therefore regarded as improvements. Among bike riders and activists there's a certain pressure to praise the latest because "it'll bring more people to the sport and ultimately increase our political punch." Most people who make a living in sales like it because new stuff is easier to sell than old. Magazines (in any field) generally like new things (of any kind) because it's something to write about, and new things are heavily advertised.

Still, the specialty shifters weigh two to three times as much as other shifters, and cost three to six times as much. They have narrow working environments (for the most part you have to use them with their own hubs and free-wheels). Being integrated with the brake levers, they're vulnerable in a crash; and if you wreck one shifter/braker unit you'll probably have to replace both, because it's nearly impossible to buy just one. There are, in other words, tradeoffs.

Your choice of technology affects your ride, and you don't have to embrace every available convenience. Although it may be hard to break the habit. The more accustomed we become to microwaves (which I use) and computers (them, too) and point-and-shoot cameras (sometimes) and technological shortcuts in our daily life, the more likely we are to insist on the same magic in our recreational gear. (I say "we," but I mean "me.")

I haven't decided that's bad, but for me, personally, I'm not sure it's good. When I don't enjoy the process but care only about the result, I take the hi-tech shortcut. I cook oatmeal in the microwave, wash dishes with the dishwasher. I buy more bread than I bake.

As a gross generalization, results-oriented cyclists can be lumped into three groups: Racers, who want high finishes; re-entry adults, who are most interested in recapturing the joy of pedaling, without the hassles of mis-shifts; and fitness-chasers, who use

RIVENDELL BICYCLE WORKS

their bikes as exercise machines.

Since racers represent skill, fitness, experience, youth, and potential all in one photogenic package, advertising uses them to sell gear to the other two groups.

In any industry (not just bikes) once tools reach a certain level of maturity and manufacturers reckon that everybody already knows about it and everybody who wants one has one, they develop technologies that eliminates the need for skill and just gets you the result. The idea being that instant expertise will get more people into it.

The fishing industry did it. If you fished before the 1940s, you used either a fly rod or a bait-casting rod with a level-winding reel. Both take a certain finesse developed after months of practice and hundreds of tangled lines to learn. Then somebody developed the open-faced spinning reel, which allowed anybody who could throw a rock to cast without tangling the line, and almost overnight fishing quintupled in popularity, and try as I might, I can't see the harm in that. The bike industry is searching for the same kind of technological breakthrough.

But usually a technological change that shortens the learning curve for those who require it takes away something for those who don't. And, when manufacturing is controlled by large manufacturers whose profitability requires economies of scale, there's no chance that old and new technology can coexist. They just can't sell enough of the old stuff to justify its continued production. We can root for it until several cows come home, but manufacturers need paying customers, not pathetic, nostalgic cheerleaders.

That's why it's hard to impossible to buy A-frame backpacking tents, manual cameras, lightweight, all-leather hiking boots (especially made in Italy, Switzerland, Austria, and the U.S.), windup watches, and slide rules. Although each of these items offers something of value its replacement doesn't, their benefits appeal more to hard core users than to the mass market, but once an activity goes mainstream, mass market sales are what supports it, and the hard core stuff dies from no demand.

In the bike world, downtube shifters are the lightest, the simplest, and the most beautiful on a bike. Typically, they have a friction option which allows them to work with any freewheel or cassette or chain, and there's no way you can wreck one in a crash.

Bar-end shifters are one step up in convenience, one step down in weight and aesthetics. They're probably the best choice for loaded touring or curved-bar trail riding, but they're hard to get and may die soon.

If you've used normal shifters and just want your next one to have STI/ERGO, that's understandable. You probably just want some variety—it can't be total dissatisfaction with downtube shifters or bar-ends that's driving you, because there's nothing heinous about either. If you haven't experienced downtube shifters or bar-ends and you can find a bike that has them, don't be quick to write them off as caveman technology. They work great, and will remain popular with experienced non-racers who pay full pop and ride their bikes a lot and all over.

END

CATALOGUE & PRICE LIST

CAMPAGNOLO NUOVO RECORD DOWNTUBERS

Shifting with ERGO/STI without ever having used these is like nuking a potato without knowing how to bake one. They were the shifters of choice on 85 percent of the pro bikes from 1970 through 1984, and Eddy Merckx won ninety-eight point infinity of his pro races with these. Pure friction, featherweights, last forever. For brazers. 39g/pr.

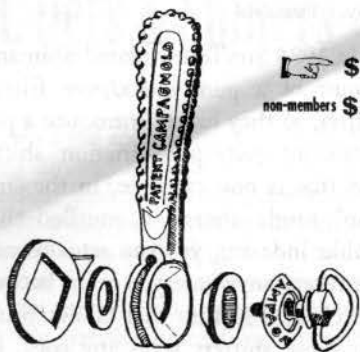

☞ \$21
non-members \$26

SUNTOUR SUPERBE PRO NOLAT DOWNTUBERS

Made in 1986, and probably the most expensive-to-make downtube shifters ever. Both shifters have SunTour's power ratchet, and the right lever has an index mode as well, and if you set it on "UL" they'll click with a 6-speed Sachs and Shimano free-wheels. Many people who have used them regard them as the best shifters ever made. 100 pair left. 82g.

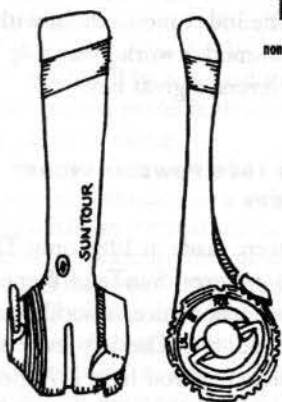

☞ \$35
non-members \$39

SUNTOUR SPRINT DOWNTUBERS

New, made in 1986. No indexing option shifters with Power Ratchet left and right. Pure, perfect, slender and pretty. The finish is a step below the Superbe Pros, but they shift as well and weigh less, and still look good enough for any bike. Put these on and you will never, ever, wish for anything else. 59g.

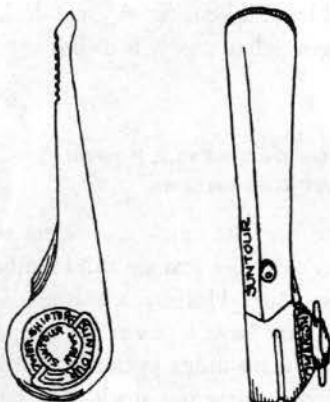

☞ \$28
non-members \$34

RIVENDELL BICYCLE WORKS

SUNTOUR SUPERBE PRO LAT DOWNTUBERS

In 1986 SunTour violated Shimano's patent of a pure index/pure friction shifter, so they had to introduce a pure index/not-quite-pure friction shifter, and this is one example. In the "friction" mode there's a muffled-click. Unlike indexing, you can actually move the levers anywhere you want between the click, a feature that allows you to use these shifters with any cogs, just like a friction shifter. But the real secret is that SunTour snuck in a pure friction mode halfway between the index and soft-click mode, so if the soft clicks bug you, just set the dial (there's a dial) halfway between stations. The left lever is a power ratchet. The index mode clicks with 7-speed Sachs and Shimano freewheels, and the friction modes work great. 84g (sans cables/housing, which they come with). Beautiful levers, a great buy.

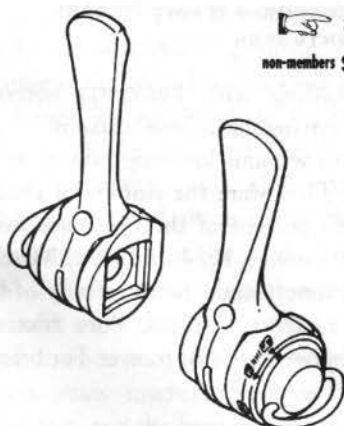

 **\$24**
non-members **\$29**

SUNTOUR 1986 POWER-RATCHET BAR-ENDERS

These were made in 1986 only. The right side indexes SunTour 6-speed clusters but has a nice, smooth pure friction mode, too. The left lever is a Power Ratchet. If you have a 7-speed cluster, use the left on the right, because it pulls more cable. Comes wrapped up in a package, complete with cables and housing. A great deal, our biggest seller, supply is dwindling.



 **\$44**
non-members **\$48**

SUNTOUR OLD STYLE POWER RATCHET BAR-ENDERS

These are the ones that used to come on old Fujis, and are still Freddie "Million-Mile" Hoffman's shifters of choice. They have a power ratchet in both levers, no index option, and are DNOS—dirty new old stock. All that means is the show signs of uncovered storage. With or without cables and housing.

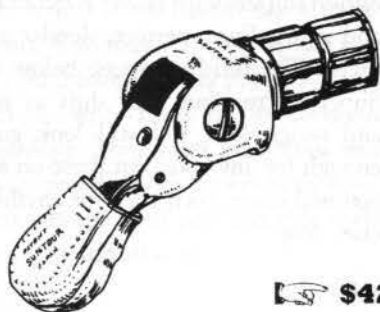

 **\$42**
non-members **\$47**

Rambling on About R. Ders & Shifters

A bike has a fixed length of chain, and the only way for it to be long enough to work when it's on the biggest front and rear cogs, and not be too floppy when it's on the small cogs, is to size the chain for the big rings and cogs and have something take up the slack when it's on the small ones. So that's one of the rear derailleur's two functions—changing the effective chain length to suit whatever chainring and cog its on. The part of the rear derailleur responsible for this is the lower cage and pulleys. When the chain is on the biggest chainwheel and one of the biggest rear cogs, the derailleur cage rotates forward, allowing the chain to take the straightest possible path through the derailleur, which reserves more of the chain for the big cogs. Then, as you shift to the smaller front chainwheels or smaller rear cogs, it rotates backward, bending the chain through a more circuitous path, so it doesn't hang loose and flop about.

Its other function is to shift the gears from cog to cog, and it does this by pivoting inward toward the large cogs, outward toward the small ones. The part that pivots is the body, sometimes called the parallelogram, because on most current derailleurs it's shaped like one. The cage and pulleys (above) are connected to it. When you mount a rear derailleur onto the frame, a spring in the parallelogram holds it outward, to the right as far as possible. To shift the derailleur inward toward the large cogs, you pull the parallelogram

against the spring. You wind (shorten) and unwind (lengthen) the cable by pulling back or pushing forward the shift lever; like winding or releasing thread from a spool. }

You have to create enough friction in the shift lever to prevent the spring in the parallelogram from unwinding the cable and pulling the derailleur to the right. You do that by squeezing the shift lever assembly together by means of a bolt that goes right through the middle of the base of the shifter. If your bike shifts by itself, tighten the bolt to increase the friction. If you tighten it too much it'll be too hard to pull back, since friction works both ways. That got people to thinking.

So sometime around 1970, France's Simplex introduced a friction lever which had an internal spring that countered the spring in the rear derailleur, so it didn't require as much friction to resist the pull of the rear derailleur's spring. This same mechanism is known as "retrofriction," named for the retro, or backwards force exerted by the counter spring. Retro-friction levers are won-

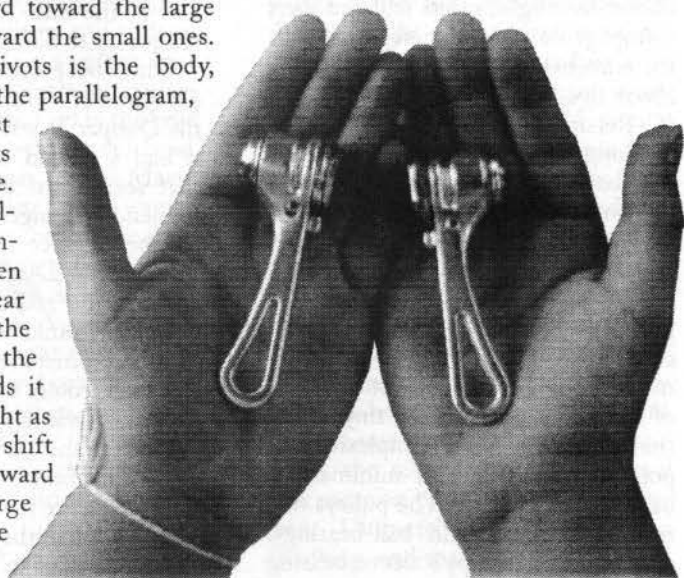

Simplex's retrofriction downtube shifters

Huret's Jubilee

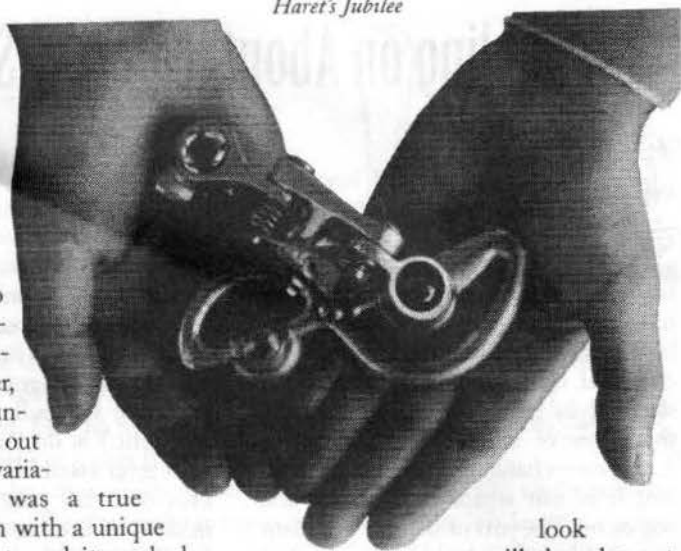

derful to shift with. You can set the pull-back resistance light, and the counter spring helps the lever resist the pull of the rear derailleur spring.

A year or two after Simplex introduced its retrofriction bar-end shifter, Shimano and SunTour (Japan) came out with their own variations. Shimano's was a true retrofriction design with a unique spring arrangement, and it worked great. SunTour's version did away with the spring, and used a ratchet instead. SunTour called its mechanism the Power Ratchet, and since SunTour was bigger than Shimano in the early '70s, it was this design that almost immediately made it onto every average-or-better touring bike sold in this country. (Racers still used Campy pure friction downtube shifters.)

Then in the early '80s, Simplex brought on a high-end retrofriction down tube shifter aimed at racers, and almost overnight, racers replaced their Campagnolo pure friction levers with the retrofriction levers. It took Campy about five years to introduce its own (C-Record) retrofriction lever, and indexing killed it a couple years later. Too bad—it's a great shifter. It's the one on the previous page.

The lightest rear derailleur in modern times was Huret's Jubilee, introduced in 1972, and shown on this page. It weighed 140g, nearly 40 percent less than a typical top-end 1997 model. It was also the most beautiful of all rear derailleurs, a tiny, shiny thing that combined complexity and polish in a paragon of minimalism, beauty, and function. The pulleys had real cups, cones, and ball-bearings, making even Campy's sleeve bearing

look
ill-thought out.

The lower pulley was toothless and smooth, another against-the-grain detail that suggested Huret's designers were thinking harder about rear derailleurs than anybody else, and also unlike everyone else, were not suffering from Campy envy. Every part was forged, not die-cast or stamped, and polished to high heaven. The Jubilee never became popular because Campy was better distributed, already dominant, and worked as well, anyway, so why change? You could buy Jubilees for \$35 in the mid-'70s. New ones now sell for up to \$350.

The best-shifting wide range derailleur of all time was also a Huret: the Duopar. It was called that because it had a second (duo) parallelogram that seemed to be the secret of its tremendous range and crispness. And if the Jubilee was the World's Prettiest, the DuoPar was the World's Ugliest. You could hold one in your hand and think: "If I had a hammer, some sheet metal, and a few rivets and screws, I could do that in an afternoon." It was also the derailleur of choice on the very first modern-day mountain bikes and all the best tandems, since it shifted over 12 x 32 freewheels like they were 12 x 19s.

The late '70s to early '80s produced

CATALOGUE & PRICE LIST

the best-working, lightest, most affordable rear derailleurs ever—a Golden Age of sorts. Three things conspired to make it so: (1) The Japanese ¥ was weak, so the American dollar bought a lot. (2) SunTour and Shimano both were blessed with the rare combination of competence and humility. (3) They were determined to build derailleurs that outshifted Campagnolo's most expensive models at a fraction of their price. In the early '80s you could buy a \$250 bike with a \$15, all-aluminum rear derailleur that weighed about 220g, and had a clean design with a simple, appropriate, polished aluminum finish. Most also included such nice features as pivoting cable guides, cast- or forged-in model names, and inside cage plates and parallelogram cages that were finished off as well as the more visible outer ones. Models such as SunTours V-Luxe, VGT, and Cyclone, and Shimano's pre-Ultegra 600 paved the way for those companies.

Simplex made its last derailleurs in the mid '80s, not coincidentally at the start of indexing. I don't have any inside knowledge of what killed Simplex, but it's not foolish to guess that, being both old and French, Simplex was reluctant to cast away decades of tradition to make indexable mountain bike derailleurs and shifters. Even if it had tried, it wouldn't have gotten the OE (original equipment) spec it needed to at least get in the head of the American bicycle buyer's head. Eventually Simple was sold to Mavic, France's top rim-maker. Mavic wanted to start making other components, and the early Mavic drop parallelogram rear derailleurs (models 801 and 851) are now prized. Then Vitus, another French company, bought the Simplex tooling from Mavic, and never did anything with it. And then ski maker Salomon bought Mavic and Mavic refocused on its wheels, dropping the other components altogether, who knows where all that wonderful derailleur and shifter and crank tooling

is now? Some French guy, probably.

A bit after Simplex died, Huret was bought by Germany's Sachs (Fichtel-Sachs) and after a couple years of putting out Jubilees and Duopars with a Sachs decal on them, that production was retired, and the Jubilee and Duopar are long gone.

SunTour, inventor of the slant parallelogram rear derailleur that all modern derailleurs (except White Industries) now use, died in 1993 or 1994. Shortly before it went down, it joined forces with Sakae and Dia-Compe, two other Japanese companies. SunTour is introducing a line of low-end Taiwan-made parts, but nothing you'd be interested in. Campagnolo is doing fine, S and its derailleurs are beautiful. Compared to its classic Nuovo and Super Record models, the new ones are spit-polished, shiny, heavier, and more generic-looking. Sachs makes some beautiful models, too, at least at the very high-end (New Success and Quartz). Still, one gets the feeling that back in Germany, Sachs's top management wishes it were an internally-gear world.

Shimano is the bike industry's A+ student/homecoming queen/retirement home volunteer/star athlete/erector set champion/800-pound gorilla of the bike industry/girl with the curl right in the middle of her forehead. It leads the industry in strikeouts and home runs, in stolen bases and pick-offs, in wild pitches and earned run average. People bash Shimano because it changes standards and forces new ones on an industry too dependent upon Shimano to refuse them; and out of pure envy, as well. As indexed shifting systems go, Shimano raises the standard for everyone, and that's a good thing.

But here, we still like friction shifting. Not because it's harder—it isn't. But because it's more versatile, and places the responsibility for a good shift more on you than on your equipment. Ultimately that can be more satisfying, and that's not a bad thing.

SIMPLEX #5500 REAR DERAILLEUR

The last of the classic drop-parallel-ogram styles, it shifts great, goes up to 26T, weighs just 199g, and sells for \$200 in Japan. We thought our source dried up, but no. Back again, but this is it. Wonderful! Not indexable.



☞ \$90
non-members \$100

SIMPLEX #6600 REAR DERAILLEUR

A horizontal parallelogram design that shifts up to 24 teeth. It sells for \$250 (equivalent) in Japan. Lighter than 99 percent of the currently manufactured rear derailleurs, and it shifts as well. If you don't need more than 24 teeth in the rear, this is a great buy.

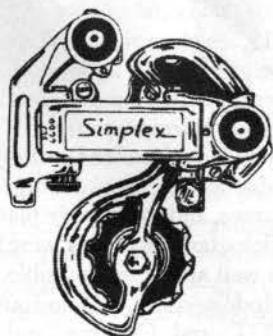

☞ \$50
non-members \$60

SUNTOUR XC PRO SHORTIE

This was SunTour's best triple-compatible rear derailleur, and it came in three versions, differentiated by cage length and rear cog capacity. This one, the shortie, handles rear cogs up to 28T, which sort of makes it the derailleur for people who know better, which is good, and those who don't need larger than 28T rear cogs. It shifts great, looks great, and is beautifully made. Our formerly huge stock of these is dwindling, and the same quality contemporary rear derailleur costs twice as much. 235g.

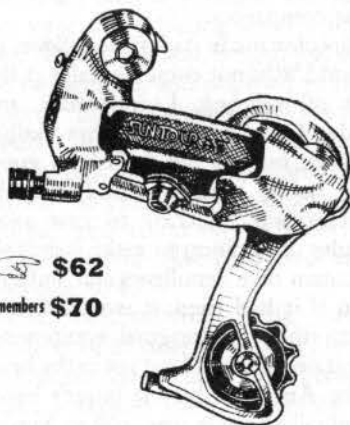

☞ \$62
non-members \$70

SACHS CENTERA LONG CAGE

Sachs is German, but Sachs bought France's Huret, and that explains why this German derailleur is made in France. It shifts great, but its cage and the rear half of the parallelogram are steel. Mostly silver, with a black outer parallelogram. By old derailleur standards it's ugly; by current standards it's average, and in fact looks a lot like the SunTour above. Shifts up to 32t and wraps up to 40t (front chain-wheel difference plus freewheel difference). 302g, which is lighter than it looks and not all that heavy these days. A good choice if you want good shifting, cheap.

☞ \$30
non-members \$34

Saddles & Accessories

BROOKS B.17 SADDLE

The prettiest saddle in the world, and the most comfortable we've sat on. A spiffed up (just for Rivendell) B.17 with Brooks Pro-thick honey brown leather, large, hand-set copper rivets, chromed rails, and a chamfered lower edge.

Wide enough to support your sit bones; shaped right so it won't crunch and numb your genitals, perhaps leading to the big I. Properly set up, the rear portion is slightly higher than the neck and nose. Get it right! Weighs 513g, and worth every mg. A perfect mate for a Carradice.



 **\$65**
non-members **\$70**

BROOKS TEAM PROFESSIONAL SADDLE

A relative newcomer to the Brooks line, introduced in 1964 or so, and almost immediately all non-French professional bikes came equipped with it. Compared to the B.17 it's 10mm narrower in the rear, and weighs about 40g less. Most riders prefer the wider B.17, but others have been riding Pros for twenty years plus and won't give them up. Has 19mm hand-set copper rivets.

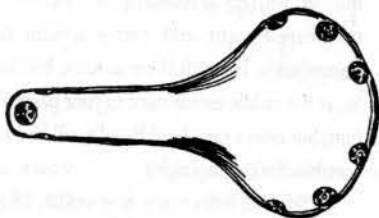

 **\$65**
non-members **\$70**

BROOKS B.72 SADDLE

The original mountain bike saddle, a two-railed jobber which requires either a straight post or the increasingly hard to find Joe Breeze Seat Sandwich. Black, with integral loops for carrying a Carradice or ACME saddlebag. The ideal saddle for riding upright. Sold with cheap-style clamp that works great with a cheap-style post, which we also sell.

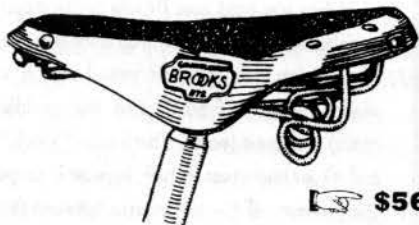

 **\$56**
non-members **\$60**

PROOFIDE

Brooks's pink proprietary blend of beeswax, candle wax (recycled?), citronella oil, tallow, and "cod oil"—presumably from the liver, but the cod ain't talking. One or two treatments per year will help that leather saddle; ten will hurt it. 2.75oz with the tin.

 **\$5**
non-members **\$6**

BROOKS TENSION TOOL

In light of Brooks's cautions against overtensioning, the rate at which we sell these tools scares me. Cute, compact, chromed, and with the Brooks logo. No other wrench works a tenth as well, but don't overtension your saddle.

 \$5

non-members \$6

CARRADICE SADDLE BONNET

You put it on your saddle to keep it dry in the rain. The neat thing about this one is that it accomodates a B.17 saddle with a Carradice saddlebag. Black.



 \$14

non-members \$16

About That Leather Saddle...

It's not like a baseball glove you have to moisten with oil to soften up. If it's a Brooks, it's shaped right and pretty comfortable immediately. In truth there is some breaking in, as the saddle molds itself to your particular butt, but even a new, hard Brooks will be comfortable if it's set up right.

Before you mount any new saddle, even a new plastic one, measure your saddle height from the center of the bottom bracket to the top, where you sit. Brooks saddles are taller than most plastic saddles, so to find this same height with one, you'll probably have to lower the seat post a little.

When you hold your Brooks pretty much horizontal and look closely, you'll see that the rear portion that supports your bones is a shade higher (3-5mm?) than the middle (neck) and front (nose). That's called "pitch," and it's an important feature, because it keeps the pressure off the tender area between (sit down) your crack and genitals. Soft saddles don't always do that. Many times, your sit bones rearrange the gel in them, squishing it right up at you, putting pressure where there shouldn't be any. The key to comfort, at least in a leather saddle, is sufficient width to keep

the saddle from penetrating you; and elevating the rear portion so the neck and nose don't ride high and tight against the part of you that's not supposed to get pushed up against. Ironically, if you're used to a skinny plastic saddle that penetrates into that region, you might find a more supportive saddle, like the B.17, slightly uncomfortable at first. Assuming it's at the right height and angle, the discomfort is probably due to your sit bones getting used to the pressure of support. Put up with it for a week or two, and eventually the pressure on the saddle will make small depressions, and you'll be fine after that.

CARE

A light coating of Proofide once or at most twice a year, topside and bottom. In wet weather, cover it with a bonnet (we sell) or plastic bag—almost anything will do. If the elements get to it and your saddle starts to sag or flare, try tensioning the nose. If that doesn't work, drill 5 to 6 holes in the lower edge, forward of the seat post and on both sides, then lace the two sides together with a shoe lace. That'll get it back into riding shape. With proper care and not tons of it, a Brooks will last from ten to thirty years, aging well.

Saddle Pillars (seat posts)

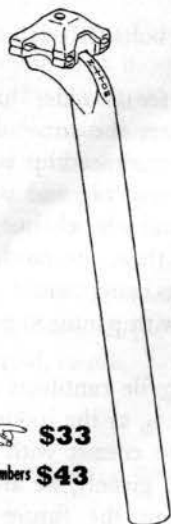

 **\$33**
non-members **\$43**

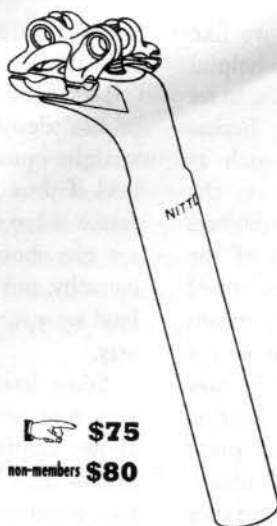

 **\$75**
non-members **\$80**



 **\$10**
non-members **\$12**

NITTO ONE-BOLT SEATPOST, 27.2 X 330MM

It looks like a Ritchey—no surprise, since the Ritchey is a Nitto post tweaked here and there for Tom. Light, strong, pretty, easy to adjust, and what else matters? These used to be owned by Specialized, and they sport that logo. If it bothers you, take it off with light sanding or Easy Off. (No offense to Specialized.) 330mm long, 235g. Terrific post, and a steal at this price, going fast, and replacement posts of the same quality will cost around \$65.

NITTO FROG POST 27.2MM X 210MM

Nitto calls it the Jaguar, but it from the side it looks like a Frog. Two-bolters are slower to adjust than one-bolters, but can be mechanically superior, since they're less prone to slipping and require less force than a single bolt. This one's way easier to use than the old Campy, since the bolts are 6mm allens, accessible from underneath. Nitto claims this is the strongest seat post they've ever tested. If you want one, please be prepared to wait. 210mm x 27.2mm only. 268g.

DECENT CHEAP-STYLE SEAT POST

For any saddle that has one of the cheap-style clamps. It works well on the Brooks B.72, and this one's 300mm long and silver aluminum—so you can put it on a nice bike without feeling bad. We always stock plenty of the revered 27.2mm size, but will try to have a few 26-somethings in stock as well. Made in Taiwan.

Brakes

In side pull brakes, we like simple designs with helpful features that allow you to set up and adjust the brakes easily and quickly. Features such as micro-adjusting quick-release on the lower caliper arms, and barrel adjusters on the upper. We aren't fans of the dual-pivot brakes, because they crowd the tire from the top, which means even if we design a frame to accept 700x35 tires, the dual-pivot brake may not allow it. Also, they make mounting fenders more difficult. Dual pivot brakes have more mechanical advantage than single-pivot models, and they feel great, and are the best choice if your hands tend to be really weak and you ride skinny tires and no fenders. But even then, a good single-pivot sidepull equipped with Mathausser pads is a close second. Don't take our criticisms of dual-pivot sidepulls too strongly. They're clever and they work great. But to us, the mechanical superiority of the dual pivot isn't all that noticeable on a real, moving bike, and in any case isn't as valuable as the clearance and adjustability of a good single-pivot design.

In cantilevers, it's easier to say what we don't like than what we like, and we don't like: soft washers that deform when you tighten the shoes in place; "super low profile" designs that require straddle wires so low they almost skim the top of the tire and make fender-mounting impossible; overly thought-out substitutes for simple straddle wire hangers. And

straddle-wire pinch bolts that damage the cable.

In general we prefer the older "high profile" designs, where the arms stick straight out and sometimes clip your heel if your foot is too big and your frame is too small and your chainstays are too short. But these are hard to come by, and aren't as convenient if you load up your bike with panniers, anyway.

Some low-ish profile cantilevers are very nice, and so long as the industry allows cantilevers to coexist with V-brakes (this is not a given!), we aren't too concerned about the future of brakes and braking.

Ted Durant, a friend from Rona Components, has been working on a Willow brand version of the old, familiar Mafac cantilever. That brake never got the respect it deserved when it was still in production, but if you threw out the shoes and put in something that actually worked, they were fantastic. The Willow brake may be a year or so away.

"V"-brakes are taking over for cantilevers, and this is not a good thing. Well-designed and properly set-up cantilevers have served well for decades with few if any complaints from anybody. V-brakes address certain cable-routing problems with fancy dual-suspension bikes, and may offer some advantages for extreme downhill riding, but for everyday, all-around fat-tire and touring use, the standard cantilever is plenty good, lighter, and a better deal in general.

CATALOGUE & PRICE LIST

SUNTOUR CYCLONE SIDEPULLS

If you like Campy and other premium sidepulls, but they no longer hold you spellbound, and you just want great brakes at a great price, these Cyclones are untouchable. They're simple, light, more honest than most, and now a relic from SunTour near the end of its heyday. They have a true micro-adjusting quick release and a rubber barrel adjuster—two features that make life wonderful, and two features lacking in all modern sidepulls. They center by means of two 5mm hex keys; simple. New old stock from the mid-eighties. Maximum reach: 50mm. Specify allen or nutted, or ask.

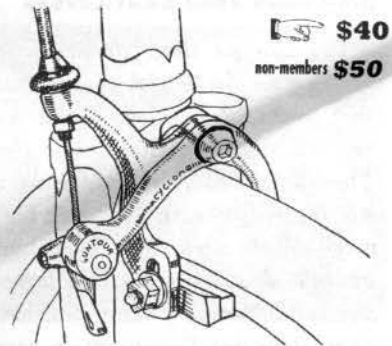

 **\$40**
non-members **\$50**

Shown with Mathausers. The original brake shoes have wheel guides.

CAMPAGNOLO GRAN SPORT SIDEPULLS

Back in the Golden Age these were Campy's poor cousins to its Nuovo and Super Record brakes. The forgings seem the same, but the finish isn't as good and the details aren't up to Nuovo Record standards. The quick-release is not micro-adjusting, but it still works well, and in tandem with the barrel adjuster, you'll have no problem adjusting them. Complete with non-aero brake levers with black hoods, cables and housing, packed neatly in a green, slightly dusty Campy box.

 **\$70 per set**
non-members **\$75 per set**



DIA-COMPE AGC 251 BRAKE LEVERS

AGC is for Aero Gran Compe, and these were Dia-Compe's best, made back when the ¥ was weak and Japanese makers had to pull out all the stops in order to compete with Italy. The black hoods fit snug, the metal is polished and buffed, and there isn't a single sign of compromise in material, design, or finish anywhere. These are at least as good as new Campy Record levers, yet they sell for \$40 to \$50 less.

 **\$65**
non-members **\$90**

DIA-COMPE #983 CANTILEVERS

Dia-Compe used to name its brakes after the model of introduction, minus the one-thousand, so you can tell what year these came out. These are the old, high-profile cantis still favored by many for their high mechanical advantage and high straddle wires. These are cold-forged aluminum, not very shiny, and have external springs. Easy to set up, easy to deal with, we like them a lot and they're dirt cheap. The stock brake shoes are horrible, so get Mathausers or at least something different. One bikesworth.

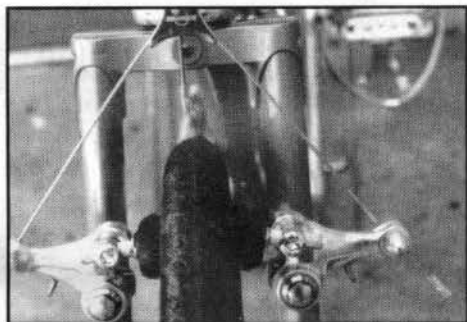

 \$15

non-members \$22

SUNTOUR SUPERBE ROAD LEVERS

Top, pro-quality road levers built without compromises. These are wonderfully simple, just six parts plus the hood. Non-aero, so you can move them around on the bar more easily, retape, switch stems or bars—all the normal activities that aero levers make difficult. You'll love the look of these, and the shape of the hood is the best. Not as thin as the old Campys, not as fat as the latter ones. Around 50 pair left—enough to last through September?

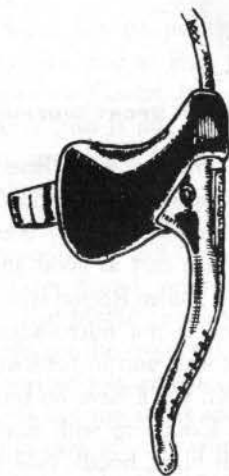

 \$40

non-members \$50

SUNTOUR CYCLONE ROAD LEVERS

Similar to a Superbe Pro but with a less fancy finish and no "window" cut out in the lever. The brake cable barrel sticks out farther and is easier to use, saving you maybe eight seconds every year or two or however often you replace the cables. The body and hood appear to be identical, and these are an equally good deal for less money.

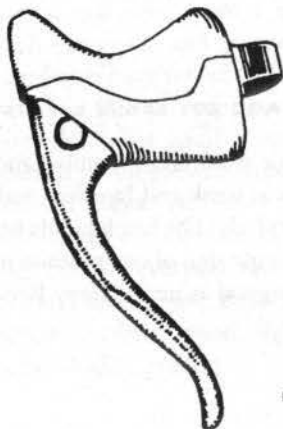

 \$24

non-members \$35

☞ CATALOGUE & PRICE LIST ☞

WEINMANN HI-CLASS CHEAP SIDEPULLS

Swiss-made non-aero sidepulls from the early '80s, with lots of nice design elements that you don't find on modern sidepulls: Wheel guides, a barrel quick-adjuster and quick-release on the caliper arms, drilled levers. The quality and appearance aren't what you'd expect from a high-priced Japanese or Italian set of brakes, but at \$40 this is a valiant effort by Weinmann to put out a plenty good brake with fancy touches and absolutely no snob appeal. Nuted centerbolts work on nutted and allen-style frames. They have a unique centering mechanism, it works

fine, but maybe somebody was thinking too hard. The brake reach adjusts from 47 to 57, so you can use these on any Rivendell road frame, as well as most of the old steel road frames built before 1987. Black hoods, but gummies may be available here and there, and we'll keep you posted in the *Reader*. A terrific buy, and the perfect brake for an older road bike you're restoring into a wonderful beater. I/Grant ride them on my LongLow, and they're great. Complete brakeset, in the box.

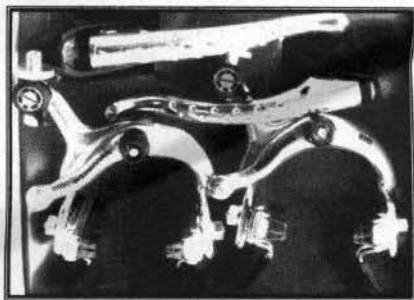

☞ **\$36 w/ black hoods**

☞ **\$43 w/ gum hoods**

CLB NON-AERO BRAKE LEVERS

CLB was a French brake manufacturer who, like many others, had the misfortune of being at its peak the same time Campagnolo was at its, and so never even came close to being a household word in bikedom. These are top, professional quality levers that have plastic lever bodies (under the hood) to save weight. These are the last levers we sell with non-black hoods. They're brown. Not a gummy brown—just plain brown. Very comfortable, with a barrel adjuster, and the nicest shape and most comfortable rest and handle of any lever I've used.

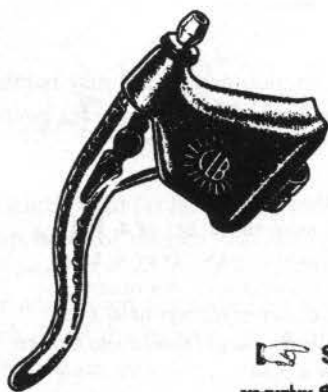

☞ **\$40**

non-members **\$46**

RIVENDELL BICYCLE WORKS

SUNTOUR XC LTD BRAKE LEVERS (MTN STYLE)

Basic mountain bike-style lever, cold forged, silver lever with a polished finish and a cast body and clamp, painted black. Perfect on English touring-style bars or, of course, the straight mountain bike bar. SunTour brand, but made by Dia-Compe. We're down to 25 pair as of 6/15/97.

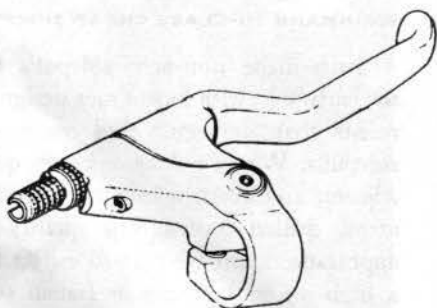

\$30

non-members **\$38**

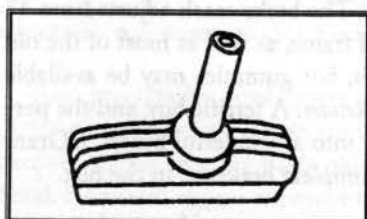

THIS IS THE FANCY SHOE. A LITTLE LIGHTER, AND WITH FANCY FINS WHICH (WE HEAR) KEEP EITHER THE PADS OR RIMS COOLER (NOT SURE WHICH, WITH LUCK, BOTH).

MATHAUSER BRAKE SHOES

The original supershoe and still the best. If you have crummy brakes, put these on. If you ride long, steep hills and your current brakes fade, put these on. Available in several styles, some of them quite fancy and costly. The cheaper ones work 97 percent as well as the fancy ones, but have a crude look about them. Peter won't put them on a bike, but I don't have a problem with them, because I can't afford the fancies. Mathausser pads make bad brakes decent, good brakes great. The

high friction compound may require more toe-in than other pads—easily accomplished by rubbing briskly for twenty seconds on a file.

PRICES:

BASIC ROAD SHOES, SET OF 4: \$14

BASIC CANTI SHOES, SET OF 4: \$20

SLIP-IN ROAD SHOES, FOR OLDER STYLE CAMPY-STYLE, SET OF 4: \$13

FANCY ROAD SHOES, FINNED AND CURVED, SET OF 4: \$34

SLIP INS TO FIT CAMPAGNOLO-STYLE
BRAKE SHOE HOLDERS.

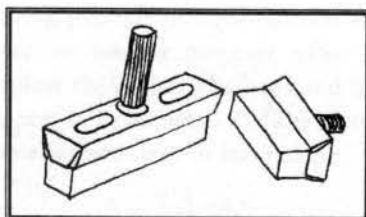
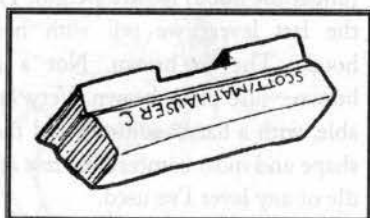

BASIC SHOES. RATHER UGLY,
BUT BY FAR THE BEST DEAL.

Pedals, Clips, & Straps



These pedals are made in Japan by MKS, formally known as Mikashima. MKS still makes a full range of nonclipless pedals from basic low-enders to absolute top quality. You've seen them masquerading as SunTour and Specialized pedals, maybe others.

MKS RX-1 TRACK (OR ROAD) PEDAL

The highest quality traditional-style pedal still made. MKS makes it for the Keirin riders, and Keirin equipment must pass the strictest quality standards of any cycling gear in the world. These are ostensibly SunTour Superbe Pro track pedals (MKS made SunTour pedals). Svelte, shiny silver bodies with black replaceable cages, sealed cartridge bearings, smooth as all get-out. 290g per pair.

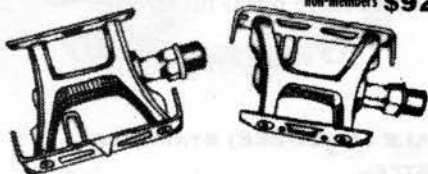

☞ \$85

non-members \$92

MKS SYLVAN TRACK PEDALS

Classic track-style cages (equally good on the road or off), with flip-tab, alloy cages, real screw-on dustcaps, and serviceable ball-and-cone bearings. Not pro quality, but they break in nicely, get smoother as they go, and ought to be good for at least 12,000 miles. Easily serviced with a screwdriver and the tool they now come with. Sometimes the factory adjustment is a little tight (as factory adjustments tend to be). If that's the case: Remove the dustcap, hold the wrench flats in a vise (a big pair of Vise Grips works), and use the hex part of the pedal tool to loosen the locknut. Then take a small flatblade screwdriver and loosen the cone (just underneath the locknut) maybe 1/12 turn. Then cinch down the locknut, put a ring of Phil oil in the bearings, and you're all set. About 315g per pair.

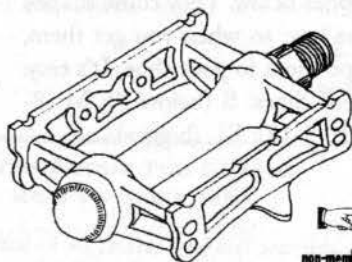

☞ \$48

non-members \$53

MKS TOURING/CYCLO CROSS PEDALS

They look like the cheap rat-trap pedals of the days of yore, but they're excellent quality, last for years of hard used, and are our first choice for off-road, city, and general rough-stuff riding. Big foot support. Adjust as above, and lube with Phil oil or grease. Excellent pedal for toe-clipless riding, too, since both sides are the same. Around 390g per pair.

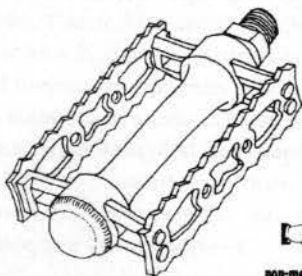



☞ \$38

non-members \$43

ALE CYCLO-CROSS AND COMMUTER CLIPS/STRAPS

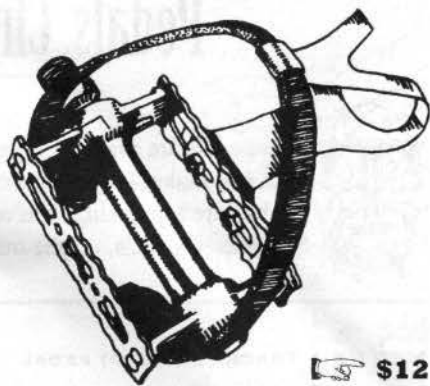
Designed for easy entry and exit, no fumbling. Good for cyclo-cross, of course (double steel clips=strong), but equally good for short commutes, big feet, and timid riders. Made in Italy by a fine company. Clips and straps included. Shown with the MKS touring pedal, not included. Jeff did most of the new illustrations in this catalogue, and I believe this is his favorite.



 \$12

non-members \$15

ALE (AY-EL-EEE) STAINLESS STEEL

Why didn't somebody make stainless clips when toe clips were popular? These don't rust, they look nice, and they're a little lighter than the Christophes below. They come shaped to fit the box, so when you get them, just shape them to your shoe. It's easy. 68g (med) Sizes: S (below 8); M (8-10); L (10.5-12); XL (bigger)





 \$12

non-members \$14

CAMPY ALUMINUM

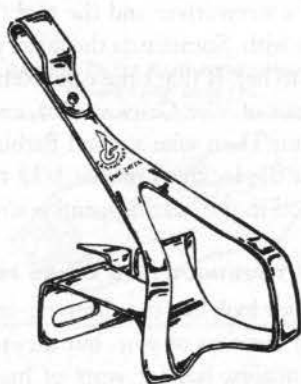
These are the neat ones with the funny cleat-guide. Very pretty, a wispy 29g in a medium (fits to 43), and they won't break unless you abuse them. S (fits to 39), M (fits to 43). No large.



 \$12

non-members \$16

CATALOGUE & PRICE LIST

INEXPENSIVE EUROPEAN LEATHER TOE STRAPS

Your basic European leather toe strap. Either French or Italian—I keep forgetting. Christophe white or Bianchi celeste. Say which color.

 \$5

non-members \$7

ALE LAMINATED LEATHER TOE STRAPS

Leather laminated to nylon. With buckle pads to keep the metal off your shoe, and they come with buttons for grabbing. These are the best toe straps still being made, by a long shot. Assorted colors, usually yellow or faded red. If you're open to any color, say so and be surprised.

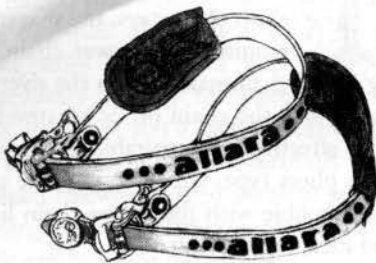

 \$5

non-members \$??

ALE BUCKLE PADS.

They slip onto any toe strap and sneak in under the buckle, so you don't feel the buckle under any circumstance. Smart, smart.

 \$5

non-members \$6



THE TRUTH ABOUT TOE STRAPS (AND HOW TO USE THEM)

Ninety-nine percent of all racers, weekend warriors, and enthusiasts ride clipless. Even our own Peter Kelley does (though he makes up for it by being the very last rider on Earth who would use anything but a steel bottle cage).

I'm a toe-strap holdout. Toe straps allow you to use any shoe; they're easy to get in and out of as long as you don't overtighten them or run the end under the slotted tab that seems to beg you to do it; and they're absolutely comfortable if you position the buckle just outside the clip. Unsafe in traffic? Loosen them in town. Unsafe in a crash? *Crashes* are unsafe, but I've crashed at least 20 times (sometimes in traffic) and never once failed to eject—even in races, when I had them tight. Still, loosen them before a long descent, just as you loosen your belt after a magnificent meal. Toe straps may not be for you—especially if you haven't tried them—but they're not the dangerous torture devices they've been made out to be. I'm keeping mine, and I'm not nuts.—G

Chain



Today's chains are designed to shift under load and span eight-cogs with short chainstays, and that means they have to be flexible laterally, which requires a narrower chain, which isn't as strong. So to compensate, chainmakers peen the rivets over so much that when you press out the rivet to take the chain off or whatever, it rips a hole in the plate, making today's chains effectively unrepairable, even with a direct-drive style chain tool (as opposed to the pliers type, which swings the pin-presser-outer through an arc and really causes trouble with the newer chain links). The Craig Metalcraft master link is a good idea, so we sell it.

SACHS M55 CHAIN

A strong German chain. Indexable, but works fine in friction, too. We've never broken one. We carry only the alternating silver-and-black ones, and all things considered, it's the one to get.

 **\$19**

non-members **\$21**

CRAIG MASTER LINK

This lets you take apart your chain without using tools (apologies to chain tool makers). It comes with instructions and is surprisingly easy to use. Two versions, which for purposes of clear communication, we will refer to by the color of the instruction sheet that comes with them: Pink: For modern Sachs chains and the silver Taya (Taiwanese chain). Yellow: For Shimano HG-50, 70, 90, 91, and the brown Taya. If you have an old chain anyway, just replace it with a Sachs, and go for the pink. Order by color, please.

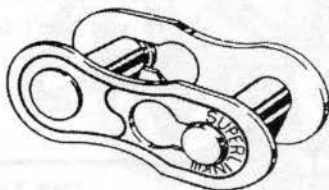

 **\$5**

non-members **\$6**

COLUMBINE QUICK-CHANGER

This tasty little nougat-of-a-gemstone/morsel lets you take your remove and install your rear wheel without touching the chain. It would be one thing if that's what it did and it weighed four ounces and cost \$15. But what it weighs is a couple grams and what it costs is \$5. Plastic.

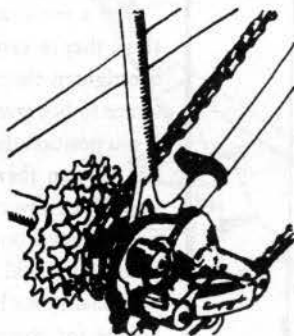

 **\$5**

non-members **\$6**

WHITE LIGHTNING

A modern, non-ingestable type chain lube. Shake like mad, then drop a drop on each pin, and you'll be all set. Repeat whenever the chain squeaks, not before.

 **\$6**

non-members **\$7**

Freewheels

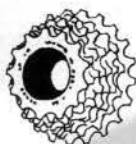

ullseye, Phil, and others have proven that you can eliminate axle-flex and breakages with a better designed freewheel hub, so you can't yell too loudly about cassettes supporting axles better. We like freewheels because there's more interchangeability among freewheel and hub brands, and there's reason to believe that in ten years you'll have an easier time finding a freewheel than a cassette that'll fit any freehub that's currently being made. The real reason cassettes have overtaken freewheels is to increase production efficiency and eliminate waste for the large hub makers—a good reason, but not one that serves your needs. Good wheels can be made either way.

SACHS FREEWHEELS

Probably the best ever made, and they're still in production, so let's be happy. According to Sachs, they're "98 percent Shimano compatible" and if you're going to worry about the other 2 percent, don't. Great splined removal system—no notches to wreck, and the tool won't slip. We'll try to keep them a good selection in stock, and are happy to order standard Sachs ratios that we don't stock, including 12-toothers. A stock Ritchey crank (46x36x24) with a 12xanything you like makes a wonderful road triple (apologies to half-steppers).

SIX: 13 x 21 (14-15-17-19)
 13 x 24 (15-17-19-21)
 13 x 26 (15-17-20-23)
 13 x 28 (15-17-20-24)

SEVEN: 13 x 21 (14-15-16-17-19)
 13 x 24 (14-15-17-19-21)
 13 x 26 (15-17-19-21-23)
 13 x 28 (15-17-19-21-24)

 **\$40**
 non-members **\$47**

 **\$42**
 non-members **\$49**

SUNTOUR ALPHA FREEWHEELS

Black, seven-speed, and we hear they index with Shimano, but haven't actually tried that, and this catalogue gets printed tomorrow. They're great in friction. Four-notch removal system (nothing to boast about). Black, limited supply, a great buy. 13 x 26.

 **\$23**
 non-members **\$25**

SACHS OR SUNTOUR 4-NOTCH FREEWHEEL REMOVERS

 **\$10 (specify type)**
 non-members **\$11**

Cranksets

RITCHEY TRIPLE CRANKS

The best 110mmx74mm (mtn bike size) crank made. With a 120mm spindle it has a nice low 151 Q-factor (distance between the pedals), and that counts a lot around here. Wonderful, smart design, probably unimprovable. Pretty satin silver finish, typical of Sugino's best cranks (it is Sugino-made). If you don't like the big LOGIC decal on the crank arm, rub it off using Quick-Glo (we sell) and ScotchBright (no). 46x36x26 rings. 170-172.5-175mm Silver only.

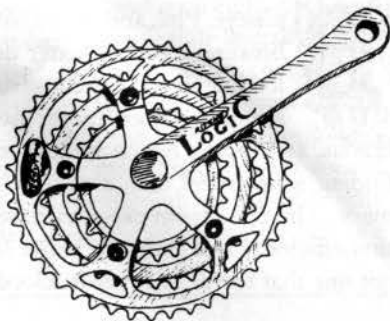

☞ \$200

non-members \$207

SUNTOUR SUPERBE PRO CRANKS

SunTour's best professional grade crank. Cold-forged, pretty, nice design, and we bought them cheap, so we can make money on them and offer you a great deal. The 172.5s have 53x39 chainrings; the 175s have 52x42 rings.

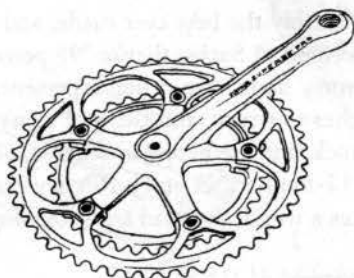

☞ \$130

\$170 w/ original Superbe bb

MAVIC 631 CRANK

This is a gorgeous crank, a smart design, as well made as any, ever. We don't have Mavic BBs to go with them, but a Phil 113 works with a double, and a 119 works on a road triple. Q-factor is in the high 130s to mid 140s depending. Only 170 and 172.5 arm designs, in 53x39 or 52x42 respectively. 130mm bolt circle, easy to get rings for. Converts to triple easily, with a Stronglight adapter ring (not listed here, but we have them for \$38). About 25 cranks left. Specify arm length and take the rings that come with them. The price here is \$15 under the last listed wholesale. We expect to be out by August, and no more exist.

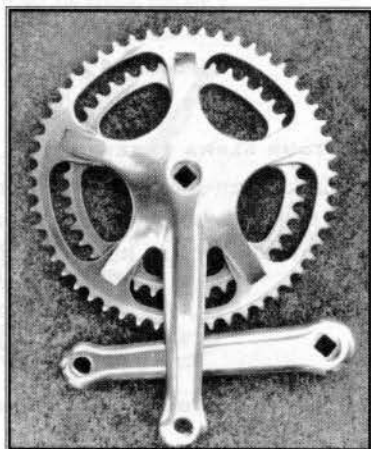

☞ \$175

non-members \$185

Willow Chainrings



All the normal bolt circles in some pretty unusual and useful sizes. All are 7075 T6 (hard, longwearing) aluminum. We've tried to make them attractive, so the larger sizes have a W cut out of the web. Silver or Apple Juice—which looks silver unless it's next to a real silver one. Prices are more normal this year. Last year we mistakenly underpriced them, and took a bad hit with each one sold.

BOLT CIRCLE	TOOTH SIZE
74 (\$18)	25
	29
	30
	32
110 (\$32)	34
	37
	39
	46 (inner)
	49
	50
	51
	53
130 (\$32)	48
	51
135 (\$32)	51
	49

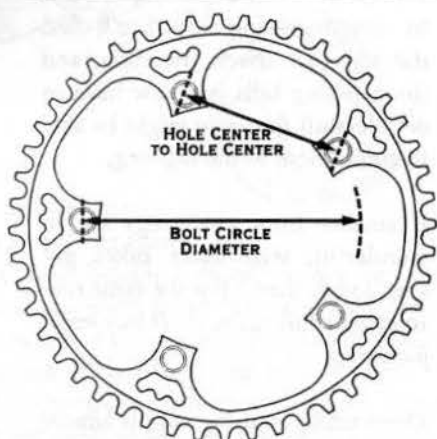

➡ See prices to the left

TRIPLIZER CHAINRINGS

Inner chainrings that convert doubles to triples, so you can use your nice road double in the steepest hills or on tour. In 130mm (modern road), 135mm (modern Campy) and 144mm (old Campy) bolt patterns. They all use a 74mm bcd inner chainring. Triplizers work fine even without the inner ring, so if you ride in the hills, prepare for the future. Machined from 7075 T6 aluminum, same as all the expensive ones.

For good shifting, keep the middle ring closer in size to the outer ring than to the inner ring!!!! (49 x 39 x 24 is good; 53 x 39 x 30 is bad, etc)

SPECIFY THE TRIPLIZER YOU WANT (MORE SIZES TO FOLLOW):

110 x 46T.....130 x 39T ...130 x 46T ... 135x 39T ... 144 x 42T



➡ **\$52**
non-members **\$56**

A Better Life With Smaller Big Rings

Just an idea: Replace your 53t chainring with something between 46 and 51, inclusive. With 12t and 13t cogs you'll still have a top gear hovering around 100-inches—more than big enough for any nonracing ride. You'll find the top gear much friendlier, and those rolling hills you now have to double-shift for—you might be able to climb them in the big ring.

If smaller front chainrings are so wonderful, why don't bikes get spec'd with them? For the same reason that adult males don't buy small jockstraps.

Downsizing your big ring is almost a requirement if you want to triplize a road double. We get calls all the time from riders who have a 53 x 39 and "just need something like maybe a 32t or 30t." A 53 x 39 x 32 won't allow you to shift directly from the small ring to the middle, because the middle ring, being closer in size to the smaller, hides under the chain's pathway. The chain can't find it until you shift all the way to the big ring, and then drop down to the middle. Make the gap between the middle and big ring equal or smaller to the gap between the middle and small one, and it's easy.

Another issue: Most triple front derailleurs work best when the small and big chainrings are within 24t of one another. If you have a 53, the smallest you can go is 29.

We continue to hear from riders who finally switched to smaller big chainrings and wish they'd done it years ago.

A 46 x 36 or 34 front combined with a 12 or 13 x 26 or 28 rear makes a good-shifting double ring set up for moderately strong riders in hilly country. The stock Ritchey 46 x 36 x 24 combined with a 7-speed 12 x whatever makes a good road or off-road triple, still giving you a 100-inch top gear and a mid-twenties low (with 700c wheels; lower with 26-inchers).

Half-step gearing, where the outer two rings are within 4 teeth of each other, and the rear jumps are big (12 x 28 at least) is another option for the thinking road rider. A 50 x 46 x 28 front combined with a 12 x 28 or larger rear gives you a huge range of gears with small increment between them. If you're confused but curious, ask for our flyer on Half-Stepping, available late August ('97).—*Grant*

Bottom Brackets

PHIL WOOD BOTTOM BRACKET

It's been around for 26 years, and over the years has been lightened, strengthened and refined to perfection. It'll last 20,000 to 30,000 miles, and Phil will repack it for less than \$20. The spindle is made from 17-4 stainless, the same stuff used to make the best ice axe heads, helicopter blades, and S & S machined frame couplers. It's really expensive, but it's the best possible material.

On paper there's nothing untouchable about Phil's design.

You could argue that the bearings should be further apart to better support the spindle, but many cartridge bearing bottom brackets have the wider bearing placement, and they still blow up. Even people who are philosophically opposed to sealed bearings, or who have had too many bad experiences with them love Phils, because...because they're one of cycledom's rare, perfect parts.

You need special tools to install them, but that's par for bottom brackets. These tools make installation much easier, and are small enough to take with you anywhere. Phils allow you to adjust your chainline, and to set your cranks up symmetrically, both good things.

You, also need the cartridge/spindle unit and the retaining rings, and we sell them separately. Specify the length you need and the threading on the rings, and if you don't know, tell us what you have and we'll risk a good guess. We stock 108, 111, 113, 116, STS-116 (for SunTour Superbe), and 119mm spindles, but can get others on request.

BOTTOM BRACKET UNIT: \$117 (SPECIFY SIZE)

RETAINING RINGS: \$23 PER PAIR (SPECIFY THREADING)

INSTALLATION TOOLS, EACH: \$18

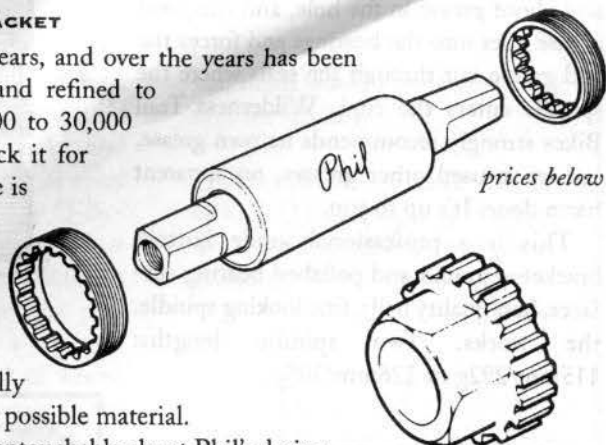

¡NOTICIA!

1. YOU CAN INSTALL PHIL BBS WITH ONE TOOL ONLY, THOUGH IT'S EASIER WITH TWO. IF YOU HAVE JUST ONE TOOL, WAIT FOR ONE OF THE LOCKRINGS TO SET UP BEFORE DOING THE FINAL ADJUSTMENT.
2. USE LOCTITE (BLUE) OR BEESWAX (GREEN) ON THE LOCKRING THREADS.
3. GREASE THE INTERFACE OF THE LOCKRING AND THE CARTRIDGE, TO HELP THEM SLIDE TOGETHER MORE EASILY.

RIVENDELL BICYCLE WORKS

SUNTOUR GREASE GUARD (WILDERNESS TRAIL BIKES DESIGN)

In the crank bolt is a tiny hole which leads to the bearings. You get a grease gun and shoot grease in the hole, and the good grease goes into the bearings and forces the bad grease out through the seals where the spindle enters the cups. Wilderness Trail Bikes strongly recommends its own grease, but we've used other greases, no apparent harm done. It's up to you.

This is a professional grade bottom bracket—ground and polished bearing surfaces, best quality balls, fine looking spindle, the works. Two spindle lengths: 115mm/292g or 126mm/305g.

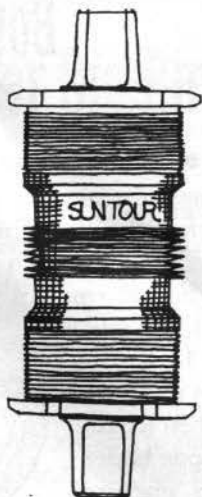

 **\$35**
non-members **\$37**

SUNTOUR SUPERBE BOTTOM BRACKET, ENGLISH

The perfect mate to the Superbe crank. We ran out of these last year, thought we'd never see them again, and recently came across twenty more. An excellent match with the Superbe crank. Phil makes a Superbe spindle, also.

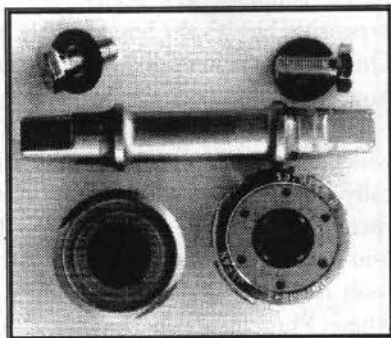

 **\$40**
non-members **\$50**

ITALIAN (SPEC) BOTTOM BRACKETS, FAIR-TO-MIDLIN' GRADE

SunTour cups with a 115mm brown boron steel Japanese spindle. Cup-and-cone, unsealed, real basic utility-workhorse bottom bracket. For most older road double cranks, and modern triples.

 **\$10**
non-members **\$15**

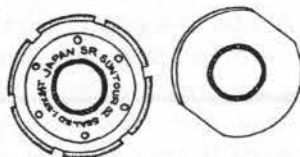
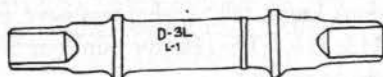

A-MINUS GRADE CUP-AND-CONE BBS, ENGLISH SPEC, ASSORTED SPINDLES! (ORDER AS "A-BB WITH ___ MM SPINDLE")

Specialized Pro spindles and barely sub-pro grade Tange Cups. Fits most Japanese cranks (not a great match with Superbes, but acceptable). Fantastic deal. All the cups are English; you specify the spindle length: 112, 115, 120, 122.5, 125.5. Available starting late July, 1997. No picture, but basically looks like the one above.

 **\$27**
non-members **\$33**

A Word About Q-Factor

Q's the distance between the outside of the cranks at the pedal hole, and determines how far apart your pedals are. I like low Q-factors (below 142 on double; below 153 on a triple), but it is politically correct to acknowledge that personal preference plays a big role, and some people, most of whom are cowboys, may be better suited to wide stances.

A low Q-factor: (1) increases cornering clearance; (2) flexes and stresses the frame less; (3) increases pedal clearance in deep single-tracks and around rocks; and (4) improves aerodynamics. Of the current cranks, the lowest Q-factors belong to Ritchey—a wonderful crank in every regard.

The very topic of Q-Factor angers some modern crank maker, and lots of these people are my friends. I'm not saying lower is better, only that I (and most of my friends) prefer low Q-factors, more for pedaling feel than for any of the four unassailable reasons stated above. Q-factor took a huge yet fanfareless leap upwards several years ago, for reasons related to production and materials. If the same change were made in crank arm length or handlebar width, both of which are less consequen-

tial, sirens would have gone off all over the world.

Short people are more affected by high Q than long legged riders, so should probably pay more attention.

—Grant

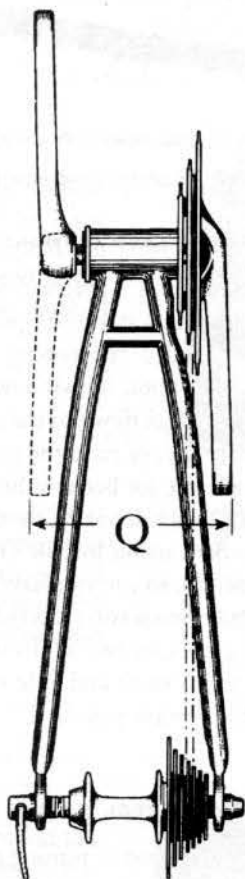

Sundries & Substances

MANILA ROPE

How many times in your life have you had none and needed it? It happens to everyone sometime, and on the bike or off, anybody will find a good use for real rope sooner or later. Manila is the best natural fiber rope available. In WWII they used it to tie huge ships to dock, because both steel cables and nylon rope snapped. We sell it by the foot in 3/16-inch and 1/4-inch; good to carry in saddlebags, at least two 5-foot lengths. Use them to strap on more gear, cinch up a drooping load

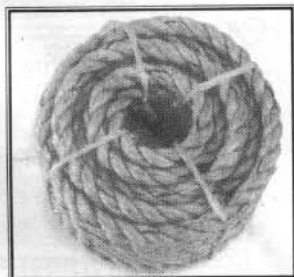

so it doesn't drag on the tire, or make a cheap belt a la Jethro Bodine. The 50-foot coils of the manly 5/8-inch. If you cut the ends and are too lazy to whip them, stop the fray with Elmer's wood glue. If you order 3 five-foot lengths, we'll send you fifteen feet, & you cut.

PRICE: 3/16-INCH; \$.08/FOOT 1/4-INCH; \$.10/FOOT. OR A FIFTY-FOOT HANK OF 5/8 FOR \$25

MEGAMID (BY BLACK DIAMOND)

A waterproof pyramid-shaped canopy with nine stake-out points, a single door, and a telescoping center ridge pole. No floor, no windows. You can stake the edges down to the ground for full enclosure, or raise the pole and let them ride up, for better ventilation. (Tip: Tie 12-inch loops of shock cord to the standard nylon loops). There's a



loop on the top, so you can leave the centerpole behind and suspend the Megamid from a line between two trees (or something). A cinch to set up, and big enough to sleep four adults, or two adults with two bikes inside. Packs small and weighs just 3 1/4 lbs, so it's small and light enough to pack in a saddlebag with room to spare. Silver with purplish panels.

 **\$178**

ALE CHROMED STEEL BOTTLE & CAGE

When you're tired of turning clean bottles greyish black or you're too poor to pay \$50 for a titanium cage, just get steel cages and be happy forever. This one's made in Italy by ALE (say "ay-elle-ee"), and once you ride with it, you're just as likely to replace it as you are to replace all your doorknobs this weekend. It's a Perfect Product. Weighs 100g.

 **\$12**

non-members **\$16**

CATALOGUE & PRICE LIST

SHELLAC

Shellac comes from bugs that bite into trees and ooze it out through their pores. Bikewise, you brush it on cloth bar tape to protect and texturize it—just like the French riders did fifty years ago. We sell 2oz of shellac flakes, which you dissolve in about a pint of denatured alcohol. Instructions included. You'll also need a cheap brush, not included. Or you can cheat and just go down to your local hardware store and buy Bullseye brand shellac for \$3.95. It comes in a variety of colors and works great, but it's not the zen experience mixing it yourself is.

BLONDE: Turns white tape creamy yellow, has little effect on darker colors.

LEMON: Brighter yellow than blonde. Three layers turn white into gold.

GARNET: Turns white tape a either a medium, almost purply brown to dark purply brown, depending on the number of coats.

SUPERMIX: A combination of Lemon or Blonde and Garnet.

 \$6

non-members \$9

BEESWAX

Made by local bees from Star Thistles, mostly. Use on all threaded surfaces as both a lubricant and locite. Pedal dustcaps, headset locknuts, cable end caps..... no bicyclist should be without it. Also helps recalcitrant screws penetrate hard wood, strengthens string, stops shoelaces from coming untied, and a googol more uses. 2 1/4oz. cup, good for years.

 \$3

non-members \$4

FRAME SAVER

East Haddam, CT. frame builder Peter Weigle developed this to protect steel frames from rusting out from the inside. If you have a super thick-walled steel frame and you know you're going to quit riding in a year, no need to get this. Otherwise, it's cheap insurance. One can does 4 frames. Not air-mailable.

 \$12

non-members \$14

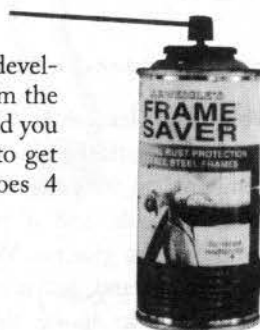

PHIL WOOD'S TENACIOUS OIL

The slowest-running oil on earth, which makes it good for places that you really should use grease for, but you either don't have any, or you're too lazy to overhaul and regrease it—just droop a squirm of oil in it and you'll be allright. If you buy pedals from us, unscrew the dustcap and drip in some Phil oil.

 \$3

non-members \$5



QUICK-GLO RUST REMOVER/POLISHER

Nontoxic, and it works so well you'll trudge around the house looking for tarnished metal to polish up, and if you don't find any there, you'll visit your neighbors—even the ones you've lived next to but have not yet spoken to. Two big toes up!

 \$6

non-members \$7



Tools

8-9-10 Y WRENCH

Everybody needs a Y wrench some-time. We sell two brands, both from Japan: Hozan, the better known of the two, and Tanaka, the one nobody over here has heard about. Taiwanese Y-wrenches are popping up all over. They have plastic centers in cheerful colors, but don't last like these top quality, hardened, precise tools.

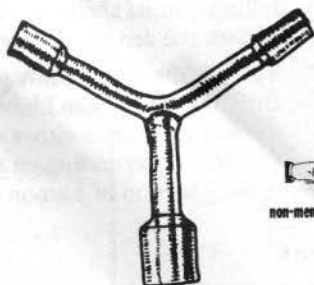

 **\$11**
non-members **\$13**

5/6 COMBO KEY

As pictured, pretty much.

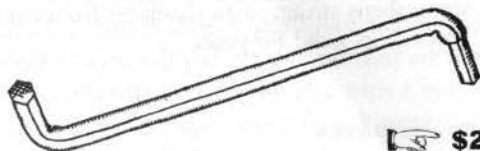

 **\$2**
non-members **\$3**

PATCH KITS, USUALLY REMA

We've had less than 75 percent retention rate with the glueless patches, compared to 99 percent with real ones. Carry both, and if your glue's dried up, use the glueless. We'll try to supply Rema brand, but if availability is poor we'd like to be able to sub something else that works. We won't send bad ones.

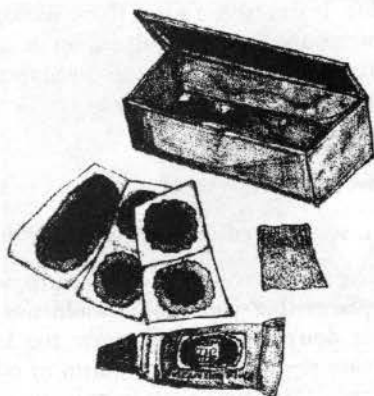

 **\$4**
non-members **\$5**

4MM BALL-HEAD WRENCH

Handy for bottle cages and racks. The ball-head lets you go in at a slight angle and still work the tool. German, top quality, kind of pricey. You can buy unhandled ones much cheaper than this, but this style is far better for mounting racks and bottle cages.



 **\$9**
non-members **\$11**

🌀 CATALOGUE & PRICE LIST 🌀

PARK FOLDING HEX/SCREWDRIVER COMBO

This weighty little bugger is always handy. Not as light as the featherweights, but it costs less, every tool on it works well, and it is easier to use. Has 4-5-6mm hex keys, plus Phillips and a flat blade screwdriver.

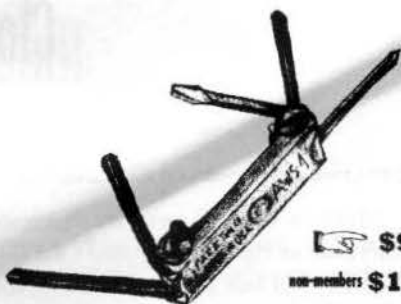

 \$9

non-members \$10

NITTO STEM PRY

It pries the stem clamp open so you don't scrape your bars, and it works so much better than a nickel in vise grips. One side is for TIG stems, the other for forged ones. Made by Nitto for Nitto stems, but naturally it works with most others. Nice tools, however infrequently used, are always worth the space they take.



 \$20

non-members \$22

THE TYRE LEVERS FORMERLY KNOWN AS VAR

Far superior for tire mounting, as it works on a completely different principle which doesn't put your tube at risk. It is bulkier than a normal tire lever, but does that matter? Not to a Carradice, not to a Tool & Tube Tote, not to a jersey pocket, not to a musette, plain or ACME. Developed for skinny, high-pressure clinchers with tight fits, but works on easier tires, too. You can't take advantage of the neat design on fat tires, but it still has two conventional priers, so no problem. Formerly VAR, but still FRENCH.

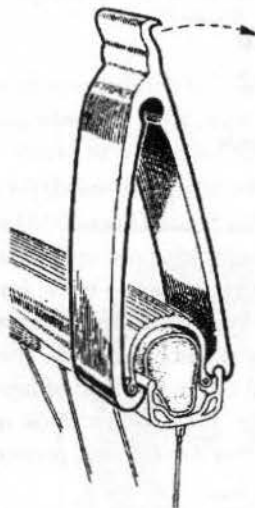

 \$9

non-members \$10

Clothing

CYCLING CAPS—GRAB BAG COLORS, \$2 EACH! (NO COUPONS, PLEASE)

Made in the U.S., so they fit better than the classic Italian brand (Apis), but don't look as classy. Two styles: One slightly goofy-looking one with a longer-than-necessary bill and a three panel top; the other, very close to classic four-panel style with a shorter, more normal bill. Colors and artwork will vary, so state your preference ("no black", etc) and do this as a grab-bag thing, keeping in mind we make no profit on these. Hot weather tip: Make visors out of these and wear them under your helmet to soak up the sweat on long, hot rides.

 **\$20**

non-members **\$22**

FIVE BROTHER HICKORY SHIRTS

"Hickory" is a generic term for the traditional, hard-wearing, all-cotton worky shirts with thin blue and white vertical stripes. Lots of people make them, but my friend Jeff, an ironworker, has worn hickory shirts daily for fifteen years and says this one lasts the longest. And, despite all that stuff about "you gotta have cycling clothes for cycling," this shirt works great for most fair-weather riding.

M-L-XL-XXL in normal or long-arm models. Cut full, but some shrinkage.

 **\$20**

non-members **\$22**

SHOP APRON

A simple, straightforward, yet clever design made by Big Smith (since 1916) with two lower pockets and one upper one. The upper one is sewn only at the top, so if you lean over to pick up something, whatever you have in it doesn't lean with you and tumble out. The adjustment is simple and clever, and kind of fun to discover by yourself. In 10oz brown duck or 12 oz navy denim. If you don't state a preference, we'll flip a coin.

 **\$16**

non-members **\$19**

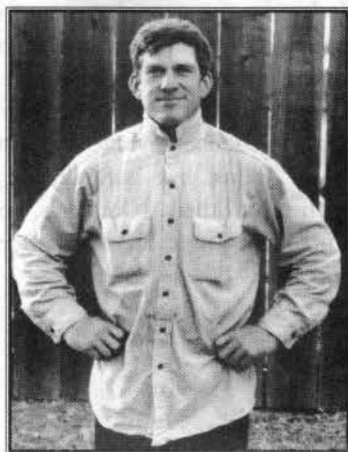

Pal Jeff, arms akimbo, rides and works in a 5Bro H shirt.



Peter, armed to fix your bike.

Safety Stuff

RAR

The Rivendell Ankle Reflector. More surface area per penny than any other, made of Reflexite, nice yellow-orange color, adjustable velcro closure, and no advertising.

 \$5

non-members \$6

CHUCK HARRIS'S REAR VIEW MIRROR

For commuting or training on roads where the cars aren't so friendly, or carrying your baby in a backpack, or riding a recumbent, a rear view mirror makes a lot of sense. If you haven't tried

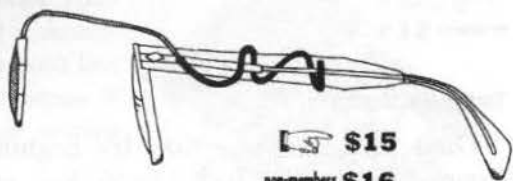

 \$15

non-members \$16



one before, it'll take a ride to get used to it. If you do use a mirror, by all means get this one! Chuck Harris, derailleur maker, fabricates them out of recycled materials. The arm is a spoke. Truly hand made, so no two can be exactly alike. Sometimes he decorates the back sides with bicycle motifs snipped from magazines. It's a grab bag, be flexible! Specify: a) wire glasses; b) plastic glasses; c) helmet

Left: Chuck grinds out another at his pedal-powered grinder.

RWF

Rivendell Wheel Reflectors. White Reflexite with velcro. Each weighs about 4g and goes on and off in seconds. Doesn't through the wheel off balance or mess with the spoke tension. There's no reason other than vanity or aesthetics to ever ride without them. Mount the cutaway portion toward the rear of the bike, away from the hub.

 \$5

non-members \$6

SMALL HELMETS FOR SUB-3 YEAR OLDS

Meets all the usual safety standards, is made in Florida, is cheap enough to buy for even a single ride, and good enough to hand down later on. Three colors, all with balloons: Blue, Yellowish green, Lavender. For 2 1/2 and under.

 \$20

non-members \$20



Anna Banana, 2 1/2, in a rare, contemplative moment

Books

BICYCLES

A small, thick-paged, glossy photo picture book that roughly covers the evolution and devolution of the bicycle, with an emphasis on unusual models. Small enough to take with you anywhere. A beautiful book, you'll like it.

 \$13

non-members \$14



TOURING BIKES

Great book, mediocre title. It's English framebuilder-physicist Tony Oliver's look at bike frames, what goes into them, what's good and bad. We don't buy his whole program (he likes brazed-on front derailleurs because he's anal about clamping things onto paint, for instance), but that's a difference of opinion, not a criticism. This book will open your eyes, educate you, fascinate you, and you'll probably buy one as a gift later on, after reading it yourself. There's no way you'll regret buying this book. You'd have to hate bikes or be nuts. We'll try to keep them in stock, but there may be delays. If your spouse is into bikes and you don't know what to buy for him/her, but you happen to be reading this right now and you have \$40 burning a hole...

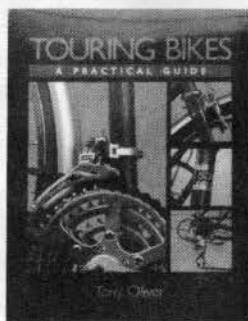

 \$40

non-members \$45

LE PETITE LIVRE JAUNE

Daniel Rebour's introductory book on bicycles, published by VAR, the French tool makers. The title translates to The Little Book Yellow in the same way that Arroz con Pollo means Chicken with Rice. The opinions expressed are Rebour's, but we agree with 97 percent. Skinny book; you're paying for the rareness and Rebourness of it all. Informative, and the collection of Rebour illustrations alone is worth the price. Translated to the language we-all speak, namely English. Not sold in bookstores. Rare, limited supply.



 \$13

non-members \$16

CATALOGUE & PRICE LIST

THE BICYCLE WHEEL

Jobst Brandt's only book. Wheel-building theory and practice. (The J is pronounced like a Y, the O is long, the B is not silent). As bike books go, a masterpiece.

 **\$22**

non-members **\$22**

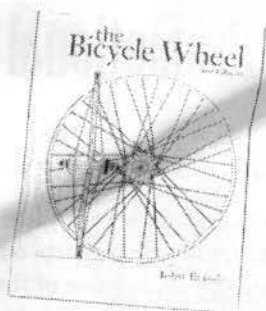

A BOOK OF NONSENSE

Edward Lear's magnum opus, first published in 1848. Limericks, short stories, a dictionary, and a botany lesson, and a double-your-money-back guarantee if you don't love this book, but you pay the return postage. If this book doesn't make you happy, nothing will. Every family needs one.

 **\$14**

non-members **\$15**



1994

 **\$8**

non-members **\$10**

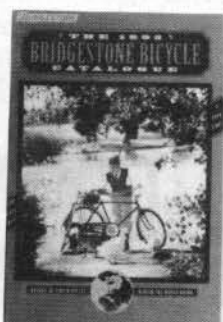

1992

1992 & 1994

BRIDGESTONE CATALOGUES

Before Rivendell I worked at Bstone, where I had \$150K catalogue budgets, and time to focus. These catalogues, and the help of many talented contributors, came of it. They were going into the dumpster, so I took them. Not like most bike catalogues. While they last. With good information and a little opinion.

 **\$7**

non-members **\$10**

There was an old person of Ware,
Who rode on the back of a bear:
When they ask'd,—'Does it trot?'—he said 'Certainly not!
He's a Moppsikon Floppsikon bear!



from The Book of Nonsense

Promotional Wear & Knick-Knacks

REFRIGERATOR MAGNETS

They come to us with those infernal chocolate-brown fake wafer magnets, but we glue rare earth magnets onto those, and if "rare earth magnet" doesn't mean anything to you, buy one of these and you'll see why these are worth.

 **\$10**

non-members **\$12**

RIVENDELL T-SHIRTS T

All cotton, unbleached, not quite white. Most people wear them all day, then sleep in them. Nice shirts. SS or LS, and the LS is made from slightly heavier cotton and has a "mock-T" neck. M-L-XL-XXL

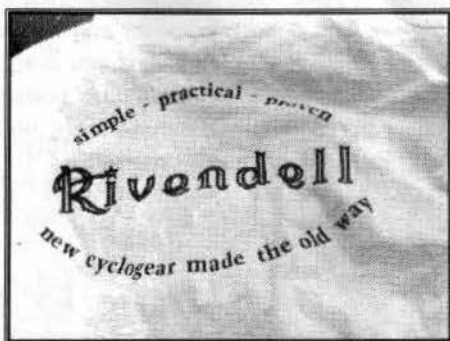

 **\$14SS \$21LS**

non-members **\$30 ea.**

RONA T-SHIRTS

RONA is an acronym for Retro Grouches of North America, and was born as a result of a column Bicycling's Fred Zarahdnik wrote (in which he coined the term "retro-grouch" scolding those who tend to like the older stuff; or something). Anyway, the shirts have a very attractive logo, a take-off on the old Campagnolo logo, and the colors are nice, too. These shirts are tongue-in-cheek, so wear them with humor! All cotton, either white or ash grey, SS or LS. Specify a preference but please accept what we have. M-L-XL-XXL



T.R. impersonating Tom Ritchey brazing a head tube joint.

 **\$15SS \$24LS**

non-members + **\$4**

Soaps! \$3 per Bar

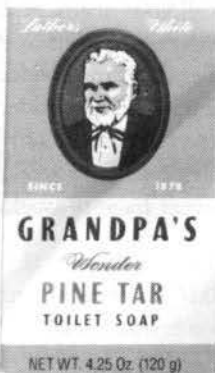

GRANDPA'S PINE TAR SOAP

Easily our best-selling item, and we often get orders for ten at a time. One guy bought fifty. To encourage riding and sell you all the other stuff for it without offering soap would be downright irresponsible. This soap, made the same way for more than a century, is the best soap

I (Grant) have used in more than 42 years of washing. It's also the best shampoo—it doesn't build up or make your hair smell like cheap perfume! Most women hate the

smell; all men love it, but it doesn't stay on your body, so no problem pre-date. Hefty, 4oz. cake. The Taj Mahal of soaps.



GRANDMA'S FANCY LUXURY SOAP

With olive oil, camomile, and orange essence. Mild and nice smelling. Unlike Pine Tar soap, it's not powerful enough to cut through the dried, two-day old onionlike stench in a nervous man's armpits (we do not get nervous around here), but fine for faces and so forth. 3.25oz.



PATCHOULI SOAP

Patchouli is a plant extract from which an oil is made, and was popularized in this country by hippies. It reminds some people of the Summer of Love; others just plain like the smell. We find the combination of Pine Tar and Patchouli makes any shower more interesting.



BAKING SODA SOAP

Among soaps of the world, it is uniquely, almost eerily scentless. Peter's favorite.



LIP IVO

The first lip balm ever, and still the best. With vanilla and peppermint, so...so if you like those two smells and you need some lip stuff...In a classic black tube with white cap. Non-addictive. The second 'i' is long.

 **\$1**
non-members **\$1.05**

Tires

W carry a small selection that will satisfy practically all your needs, and all your practical needs. These are the tires we ride every day. The 26-inch tires were measured on a Mavic 217 rim, which is 22mm wide. 700c tires were measured on a Mavic MA2 rim, which is 20.5mm wide. Weights: We weighed one sample of each tire and took the average. Width, diameter, height: We inflated one of each tire to maximum psi and let it sit for a week, because tires stretch. Then we quickly measured the tire and went back to work. Your results may vary, but not by much.

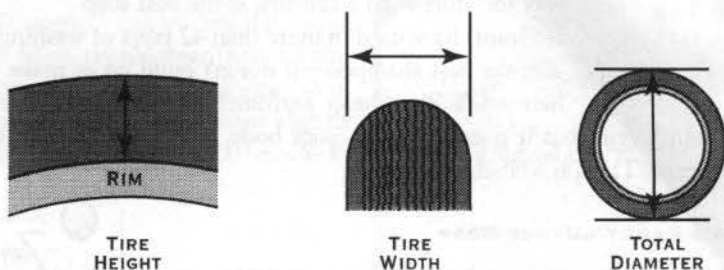

TIRE SPEC CHART				
MODEL	HEIGHT	WIDTH	DIAMETER	WEIGHT
Ritchey Road Force 26 x 1	23.8	25.4	615	240g
Ritchey Crossbite 26 x 1.1	29.3	31.5	630	355g
Panaracer Pasela-K 26 x 1.25	??	30.5	BB	246g
Ritchey Crossbite 26 x 1.4	35	36.5	641	432g
Ritchey Tom Slick 26 x 1.4	34.3	36.5	639	410g
Specialized Armadillo 700 x 26	24.9	26	680	340g
Ritchey 700 x 28	24.8	25	680	240g
Panaracer Category 1 700 x 28	24.8	24	680	260g
Avocet Road Slick 700 x 32	27	27	693.77	303g
Avocet Road Slick 700 x 35	30	32	699	370g

PRESTA-VALVE TUBES, \$4 EA.

700C

BLACK. 97G MINIMUM, 120G MAXIMUM. FITS FROM 700 X 23 TO 700 X 35.

26 SKINNY

BLACK. 93G MIN; 135 MAX. THE PERFECT TUBE FOR TIRES UP TO 26 X 1.25.

26 MEDIUM

BLACK. 140G MIN, 165G MAX THE BOX SAYS IT'S FOR TIRES BETWEEN 1.5" AND 2.2-INCHES.

26 FAT

BLACK. 168G MIN, 178G MAX. FOR BIG TIRES.

🌀 CATALOGUE & PRICE LIST 🌀

RITCHEY TOM SLICK 700 X 28, KEVLAR BEAD

Great all-around lightweight road tire. The older Japanese ones weighed 220g; these weigh 240g or so, but otherwise seem identical. Fat enough to protect the rim, grips like Dickens, and doesn't seem any more prone to punctures or cutting than anything else out there. Nice tire!

 **\$30**

RITCHEY 26 X 1 ROAD TIRE, KEVLAR BEAD

The best and absolutely the most practical skinny little 26-inch road tire that's compatible with mountain bike sized rims. It has the same tread patterns as Ritchey's 700x28, but is a little wider. For rims 23mm and narrower.

 **\$25**

AVOCET 700 X 32 ROAD SLICK

If you ride twisty descents or do any sort of high-speed cornering, this is the best tire in the world. Make sure your bike can fit it, though. Older road bikes, no problem. Many newer ones just don't have the clearance, though.

 **\$40**

RITCHEY 26 X 2.1 MEGABITE Z-MAX KEVLAR BEAD

Ritchey's all-round fat knobby. It works great in most conditions, and if you don't have time or cash to try out all models, just get this tire and ride.

RITCHEY CROSSBITE-26 X 1.1, 1.4, OR 1.9. ALL WITH KEVLAR BEAD

Great 26-inch tire, and hard to find in bike shops. Fast, tough, grippy enough in dirt, not too noisy on the street, and quite light. Specify size!

 **\$30**

PANARACER CATEGORY 1 700X28 (24.5MM)

Top quality, kevlar-reinforced casing, round combination tread, kevlar bead, 260g, and Japanese made (that'd be good). This is as skinny a tire as we'll sell, but it's still fatter than most riders ride. The sidewalls are tannish-brown. Not ugly, just a bit different from what we're used to.

 **\$28**

SPECIALIZED TRANSITION ARMADILLO 700 X 26, STEEL BEAD

It has a great, traditional mixed tread, round profile, and for hard everyday use it cannot be beat. The Armadillo refers to the extra tough casing, made of flat monofilament nylon, which runs from bead to bead. According to Specialized, it makes a casing at least as strong and puncture resistant as kevlar and doesn't wreck the ride as much. Corners great, wears well. 340g.

 **\$26**

PANARACER PASELA 26 X 1.25

We saw a wire bead version of this at a trade show, and asked Panaracer to do it for us using a kevlar bead, and they did. Just 246g per tire—a phenomenal weight for a tire of this volume. It actually measures about 30.5mm wide (it looks like a 700x35), yet has plenty of cushion for any road use, including most light-to-medium touring. For an all-around speedy, cushy, 26-inch tire, it's our top choice.

 **\$28**

Hubs • Rims • Wheels

PHIL WOOD HUBS

The Taj Mahal of hubs. Field-serviceable with two 5mm allen wrenches, but you'll probably not have to do it. Silver, fat-bodied, very pretty. In 28, 32, 36, or 40 drillings. Specify drilling and width, or call for consultation. Special models available.

 \$77 Front

 \$83 Rear

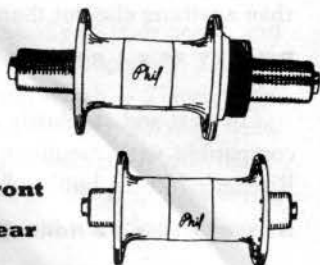

SUNTOUR XC9000 FRONT HUBS, 32-HOLE

These were the predecessors to the XC Pro hub, and every bit as good, honestly, as a hub can be. Sealed cartridge bearings, slanted flanges (it's easier on the spoke heads), slender silver bodies...all they're missing is a quick-release, but you can either get one from us or somewhere else.

 \$27

SHIMANO XTR 32H OR 36H

The beautiful ones with the skinny bodies. Top quality, pretty, and they come with quick-releases. We have about 29 of each. Specify.

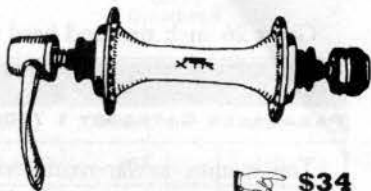

 \$34

MAVIC MA2 RIMS

This model has so many plusses to it one can only wonder why, in a non-touring clincher rim, ride anything else? Double eyelets, 20.5mm wide, 460g (that may be the reason some riders ride something else), and a track record as untouchable as Dimaggio's hitting streak. Mavic says "for tire to 700x28," and if that's an actual 28mm, it means at least any 700x32. Silver only, 32H or 36H.

 \$34

WE SELL COMPLETE WHEELS, TOO

If you buy all the parts from us and can wait 3 weeks, we can deliver to you a set of wheels that'll see you through just about anything you throw at them. Rear wheels are 3x, fronts are 2x. Butted spokes. Standard road wheels are on Mavic MA2 rims as long as we can get them. Twenty-six inch wheels are on Ritchey or Sun or Bontrager or some other good rim that meets our specs (still deciding at this point). Prices range from \$100 to \$150 per wheel, depending on the specifics. Call for details.

Racks & Cages

RIVENDELL/NITTO RACKS

The Taj Mahal of racks. Fillet-brazed tubular CrMo, nickel plated, exquisite, and built to take the hardest use. Supply may be a problem, especially with the front ones, and especially before August of 1997. As of this printing, we still have a few details to work out, so—so be prepared for delays. After September we should be fine. Still, it's best not to wait until the last minute to order.

We don't sell, but can recommend without reservation the beautiful racks made by two other guys: Robert Beckman, of Robert Beckman Designs in Bend, OR (541) 388-5146). And Bruce Gordon of Bruce Gordon Cycles, Petaluma, CA.

REAR RACK

Fits 700c-wheel bikes 52cm and larger, and 26-inch wheelers 46cm and larger. Includes brazed-on tab for rear Vista light, may fit others as well.

 **\$115**

non-members **\$125**

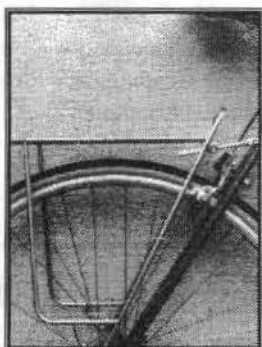
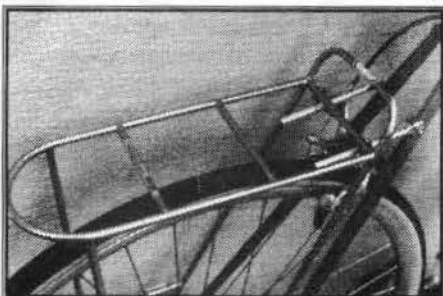

FRONT SYSTEM

We're still working on this. To date, we have a magnificent three-piece system including 1(1) a front mini-rack; (2) U-bracket; (3) Lower carrier (low-rider), but it fits only on a Rivendell Mountain or All-Rounder. We're working on a more universal front

racks that'll fit pretty much every bike, and hope to have these ready by October or November, 1997. We'll keep you posted in the Readers.

ALE BOTTLE CAGE WITH BOTTLE

Chromed steel, about 100g. Sturdy, reliable, and best of all, no amount of jiggling will blacken the bottle. It looks good on any bike, and will outlast most of them. Now it comes complete with a bottle.

 **\$13**

non-members **\$15**



Rainwear



Waxed cotton is the traditional fabric for rainy weather, and has been made in England and New Zealand for years. It smells good, it works, it looks highbrow, lasts for years. When the time comes to retreat it, that's easy, and we have the goop, just \$5 per tub. Everything is dark green, with strategically located reflective strips so you don't get smacked.

PONCHO

One size fits everybody in the world. Curiously, this outsells the jackets four to one. Inner ties keep it from flapping up. Please note plaid flannel hoodliner.

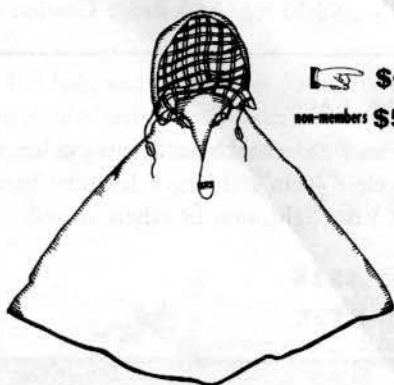

☞ \$48
non-members \$53

— Does Waxed Cotton Work? —

Of course—and it has for more than 75 years! The coating is *in* the fabric, not on it, so there's nothing to peel off or delaminate.

RAIN JACKET

One pocket. S-M-L, and the large fits to 6'3". Nice enough to wear as a day shell in good weather, too.

S-M-L

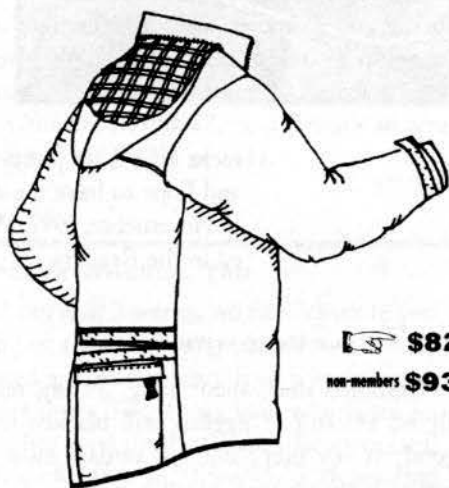

☞ \$82
non-members \$93

Wool

LONG SLEEVE WOOL JERSEYS

Sergal. Traditional, wonderful, Italian long-sleeve all-wool (Super-wash, even) cycling jerseys. Knit on a tube, like a T-shirt, the old way. Ribbed collars and cuffs, long arms and body, three rear pockets.

SIZES 3-4-5-6 (M- ML- L - XL)

GREEN WITH MAROON STRIPES ON TRIM ;

MAROON WITH GREEN STRIPES ON TRIM;

MULTISTRIPED BLUE AND GREENISH YELLOW



 **\$77**
non-members **\$82**

SHORT-SLEEVE WOOL JERSEYS?

WE'RE WORKING ON THEM. CALL!

WOOL SHORTS (KUCHARIK)

Kucharik has been making cycling clothing since 1934, and these are the best-fitting ones ever. They still ride up like the wool shorts of old, but not as much, and most importantly, they don't ride down or give you a ring around the thigh, or that "too bad I have to pour myself into a rubber suit to enjoy the sport I love" feeling, either. Often I'll get home at 1 p.m. after a 3-hour ride, and don't even bother to change until evening—that's how normal these feel. We sell lots of these, usually to repeat customers. You won't wear plastic after wearing these.

Superwash wool with a fake chamois, and even though they aren't supposed to shrink, they seem to fit better after the first washing. Want a real leather chamois? Add \$10 and wait a week. **FLASH:** We may run out of these after October. We'll try our best to keep them in stock, but apparently the special wool used is almost impossible to get.
S: to 29w; M 30-33w; L: 33-36w; XL: 37-40.

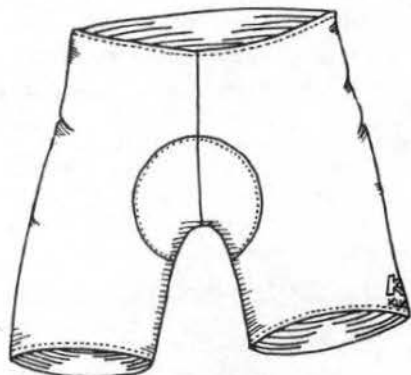

 **\$58 w/ fake chamois**

 **\$68 w/real chamois**

non-members add **\$6**

HOMEMADE SUSPENDERS

We have tried and failed to find good cycling suspenders, so we make them ourselves (Grant usually sews them). The workmanship is cruder than anything else we sell, but they're strong and seem to last really well. If you can find nicely made cycling suspenders in 3/4-inch or smaller elastic, tell us where. If you can't, buy these. Navy or red, no color choice, but usually navy. **\$10/pair.**

RIVENDELL BICYCLE WORKS

SMART WOOL (BRAND) SOCKS

Eighty percent Superwash wool with 20 percent nylon, darn it. The bottoms are thicker than the tops, they cover your ankles, the toes are tough, they don't shrink, they outlast all others we've tried.

Med (m 4.5 to 8; w 6 to 9.5)

L (m 8.5-11.5; w 10 to 12)

XL (m 12-15; w 13.5-16.5)



 \$9

non-members \$11

WOOL TIGHTS

All Superwash wool, no chamois, reinforced crotch, knit cuffs with green and maroon stripes. The wool has a good hard knit that ought to last for a long time. So much nicer for cold weather wear than lycra tights. Made in Italy by Sergal, woolmakers for a long time. If we run out of the Sergals, we'll sub Kuchariks for the same price.

SIZES: 3 (MED) 4 (LARGE) 5 (XL) 6 (XXL)



 \$12

non-members \$13

TWELVE-DOLLAR GLOVES

The perfect solution for temperatures down to about 40°. Available with full fingers or half. The rubber dots on the palm get mashed flat and smeared pretty early, but the gloves and your grip don't suffer for it. Eighty percent wool, the rest something else—feels like racoon hair and acrylic. Made in the USA, and possibly available at your local hardware store for less than we can afford to sell them for. Specify full-fingers or half. One size fits everybody on Earth.



 \$12

non-members \$13

In anything at all, perfection is finally achieved not when there's no longer anything to add, but when there's no longer anything to take away, when a body has been stripped down to its nakedness.

—Antoine de Saint Exupery

There are very few accomplishments of any value that can be gained without practice, and that which takes the least time to learn is usually the least valuable when learned.

—The Eagle Bicycle Company Catalogue, 1890

Technology is imposed on the land, but technique means conforming to the landscape. One forces a passage, while the other discovers it. The goal of developing technique is to conform to the most improbable landscape by means of the greatest degree of skill and boldness supported by the least equipment.

—Doug Robinson, for The Great Pacific Iron Works catalogue, 1974

When I am working on a problem, I never think about beauty. I think only of how to solve the problem. But when I have finished, if the solution is not beautiful, I know it is wrong.

—Buckminster Fuller

*If lilies are lily white if they exhaust noise and distance and even dust
If they dusty will dirt a surface that has no extreme grace
If they do this and it is not necessary it is not at all necessary
If they do this they need a catalogue.*

—Gertrude Stein

Acknowledgements

Jeff Thomas of Zeus Tool & Cloth drew most of the new pictures. We shrunk them down, the lines got thick, and a good argument could be made that we botched them up in doing so. The originals are so nice.

The other illustrations are the work of Kim Young, Spencer Chan, Chris Fiorini, Robert Kurosawa, George Retseck, and Daniel Rebour.

Bulk Rate
U.S. Postage
PAID
Walnut Creek
California
Permit #816

**RIVENDELL BICYCLE WORKS
1561-B THIRD AVENUE
WALNUT CREEK, CA 94596**

FOUR DOLLARS